

General Description

The AOT474 and AOTF474 use a robust technology that is designed to provide efficient and reliable power conversion even in the most demanding applications, including motor control. With low $R_{DS(ON)}$ and excellent thermal capability this device is appropriate for high current switching and can endure adverse operating conditions.

Product Summary

V_{DS}	75V
I_D (TO220 at $V_{GS}=10V$)	127A
I_D (TO220FL at $V_{GS}=10V$)	47A
$R_{DS(ON)}$ (at $V_{GS}=10V$)	< 11.3m Ω

100% UIS Tested
100% Rg Tested

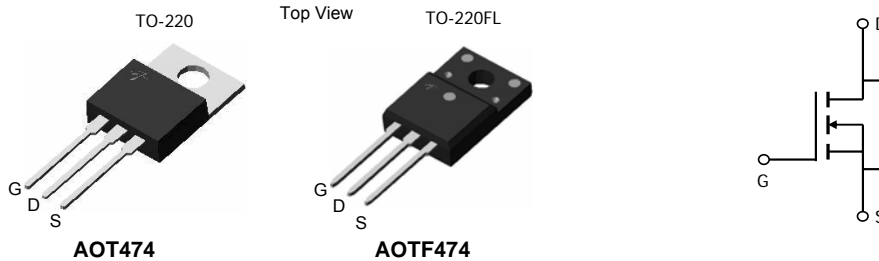

Absolute Maximum Ratings $T_A=25^\circ C$ unless otherwise noted

Parameter	Symbol	AOT474	AOTF474	Units	
Drain-Source Voltage	V_{DS}	75		V	
Gate-Source Voltage	V_{GS}	± 20		V	
Continuous Drain Current	I_D	$T_C=25^\circ C$	127	47	A
		$T_C=100^\circ C$	89	33	
Pulsed Drain Current ^C	I_{DM}	240			
Continuous Drain Current	I_{DSM}	$T_A=25^\circ C$	9	9	A
		$T_A=70^\circ C$	7	7	
Avalanche Current ^C	I_{AS}, I_{AR}	106		A	
Avalanche energy $L=0.1mH$ ^C	E_{AS}, E_{AR}	562		mJ	
Power Dissipation ^B	P_D	$T_C=25^\circ C$	417	57.5	W
		$T_C=100^\circ C$	208	29	
Power Dissipation ^A	P_{DSM}	$T_A=25^\circ C$	1.9	1.9	W
		$T_A=70^\circ C$	1.2	1.2	
Junction and Storage Temperature Range	T_J, T_{STG}	-55 to 175		$^\circ C$	

Thermal Characteristics

Parameter	Symbol	AOT474	AOTF474	Units
Maximum Junction-to-Ambient ^A	$R_{\theta JA}$	13.9	13.9	$^\circ C/W$
Maximum Junction-to-Ambient ^{A,D}		65	65	$^\circ C/W$
Maximum Junction-to-Case	$R_{\theta JC}$	0.36	2.6	$^\circ C/W$

Electrical Characteristics (T_J=25°C unless otherwise noted)

Symbol	Parameter	Conditions	Min	Typ	Max	Units
STATIC PARAMETERS						
BV _{DSS}	Drain-Source Breakdown Voltage	I _D =250μA, V _{GS} =0V	75			V
I _{DSS}	Zero Gate Voltage Drain Current	V _{DS} =75V, V _{GS} =0V T _J =55°C			1 5	μA
I _{GSS}	Gate-Body leakage current	V _{DS} =0V, V _{GS} = ±20V			100	nA
V _{GS(th)}	Gate Threshold Voltage	V _{DS} =V _{GS} , I _D =250μA	2.6	3.4	4	V
I _{D(ON)}	On state drain current	V _{GS} =10V, V _{DS} =5V	240			A
R _{DS(ON)}	Static Drain-Source On-Resistance	V _{GS} =10V, I _D =30A T _J =125°C		9.4 18	11.3 21.5	mΩ
g _{FS}	Forward Transconductance	V _{DS} =5V, I _D =30A		67		S
V _{SD}	Diode Forward Voltage	I _S =1A, V _{GS} =0V		0.73	1	V
I _S	Maximum Body-Diode Continuous Current				128	A
DYNAMIC PARAMETERS						
C _{iss}	Input Capacitance	V _{GS} =0V, V _{DS} =30V, f=1MHz	2240	2805	3370	pF
C _{oss}	Output Capacitance		355	507	660	pF
C _{riss}	Reverse Transfer Capacitance		22	36	50	pF
R _g	Gate resistance	V _{GS} =0V, V _{DS} =0V, f=1MHz	1.4	2.8	4.2	Ω
SWITCHING PARAMETERS						
Q _{g(10V)}	Total Gate Charge	V _{GS} =10V, V _{DS} =30V, I _D =30A	39	49.6	60	nC
Q _{gs}	Gate Source Charge		11	13.8	17	nC
Q _{gd}	Gate Drain Charge		8	14	20	nC
t _{D(on)}	Turn-On DelayTime	V _{GS} =10V, V _{DS} =30V, R _L =1Ω, R _{GEN} =3Ω		15		ns
t _r	Turn-On Rise Time			34		ns
t _{D(off)}	Turn-Off DelayTime			42		ns
t _f	Turn-Off Fall Time			4.5		ns
t _{rr}	Body Diode Reverse Recovery Time		I _F =30A, dI/dt=500A/μs	35	50	65
Q _{rr}	Body Diode Reverse Recovery Charge	I _F =30A, dI/dt=500A/μs	330	472	614	nC

A. The value of R_{θJA} is measured with the device mounted on 1 in² FR-4 board with 2oz. Copper, in a still air environment with T_A=25°C. The Power dissipation P_{DSM} is based on R_{θJA} and the maximum allowed junction temperature of 150°C. The value in any given application depends on the user's specific board design, and the maximum temperature of 175°C may be used if the PCB allows it.

B. The power dissipation P_D is based on T_{J(MAX)}=175°C, using junction-to-case thermal resistance, and is more useful in setting the upper dissipation limit for cases where additional heatsinking is used.

C. Repetitive rating, pulse width limited by junction temperature T_{J(MAX)}=175°C. Ratings are based on low frequency and duty cycles to keep initial T_J=25°C.

D. The R_{θJA} is the sum of the thermal impedance from junction to case R_{θJC} and case to ambient.

E. The static characteristics in Figures 1 to 6 are obtained using <300μs pulses, duty cycle 0.5% max.

F. These curves are based on the junction-to-case thermal impedance which is measured with the device mounted to a large heatsink, assuming a maximum junction temperature of T_{J(MAX)}=175°C. The SOA curve provides a single pulse rating.

G. These tests are performed with the device mounted on 1 in² FR-4 board with 2oz. Copper, in a still air environment with T_A=25°C.

Rev 0: February 2009

COMPONENTS IN LIFE SUPPORT DEVICES OR SYSTEMS ARE NOT AUTHORIZED. AOS DOES NOT ASSUME ANY LIABILITY ARISING OUT OF SUCH APPLICATIONS OR USES OF ITS PRODUCTS. AOS RESERVES THE RIGHT TO IMPROVE PRODUCT DESIGN, FUNCTIONS AND RELIABILITY WITHOUT NOTICE.

TYPICAL ELECTRICAL AND THERMAL CHARACTERISTICS

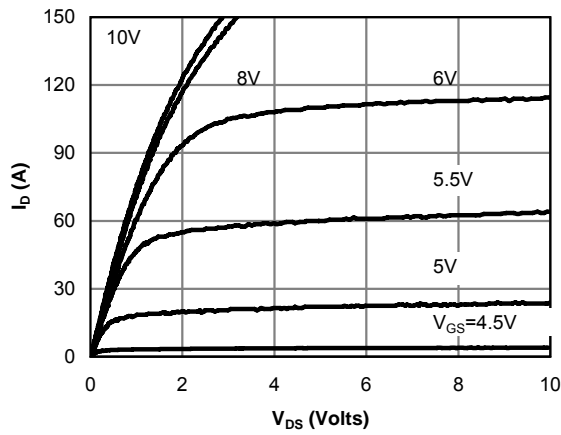

Fig 1: On-Region Characteristics (Note E)

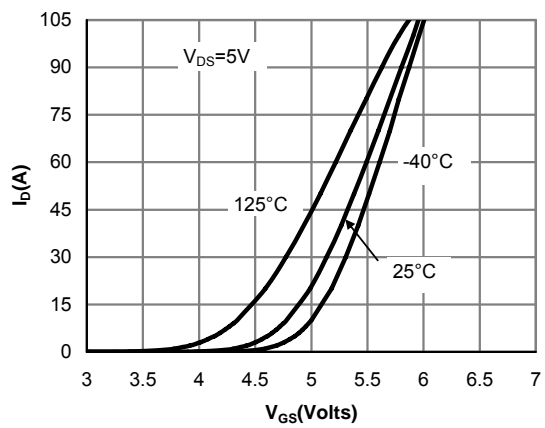

Figure 2: Transfer Characteristics (Note E)

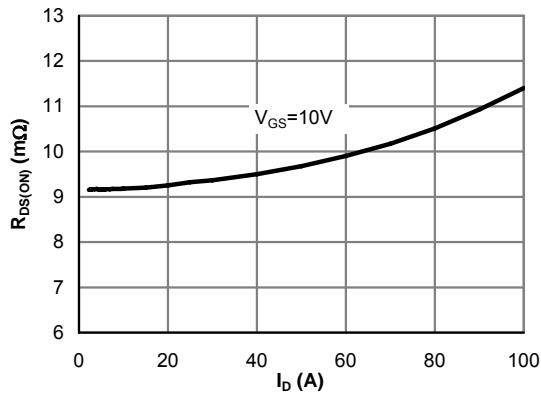

Figure 3: On-Resistance vs. Drain Current and Gate Voltage (Note E)

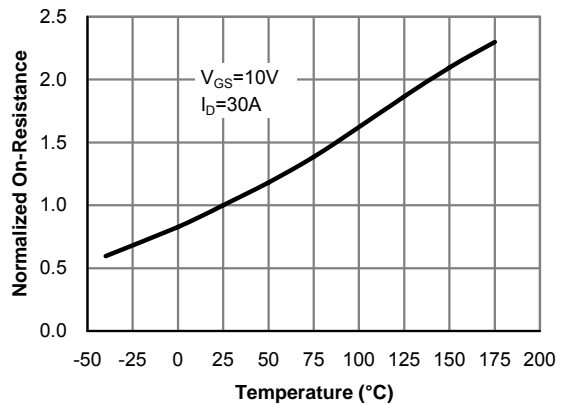

Figure 4: On-Resistance vs. Junction Temperature (Note E)

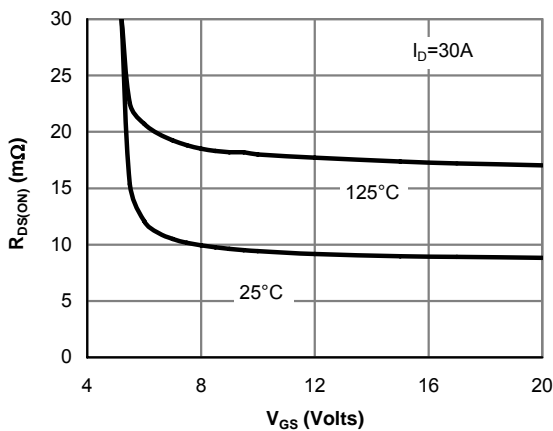

Figure 5: On-Resistance vs. Gate-Source Voltage (Note E)

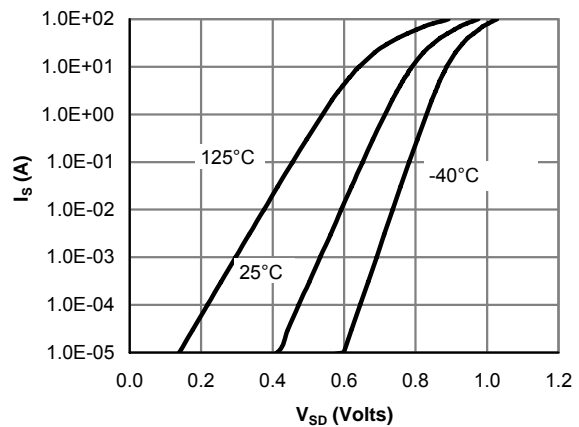

Figure 6: Body-Diode Characteristics (Note E)

TYPICAL ELECTRICAL AND THERMAL CHARACTERISTICS

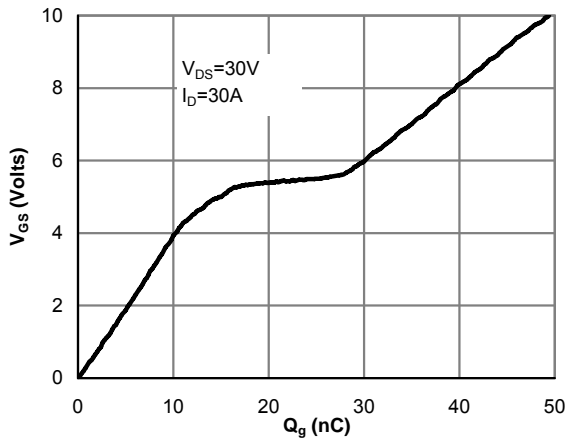

Figure 7: Gate-Charge Characteristics

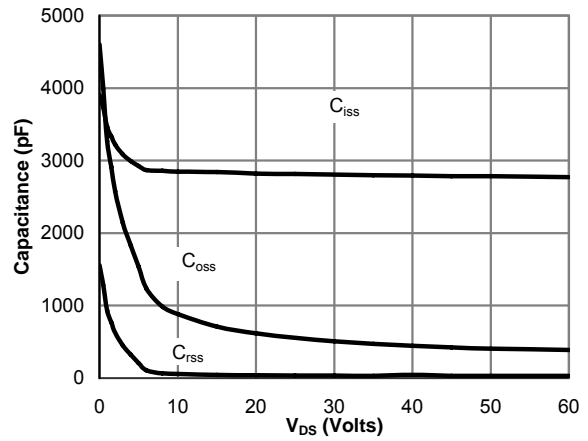

Figure 8: Capacitance Characteristics

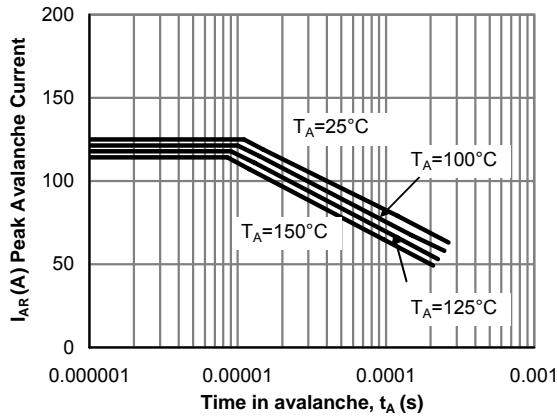

Figure 9: Single Pulse Avalanche capability (Note C)

TYPICAL ELECTRICAL AND THERMAL CHARACTERISTICS

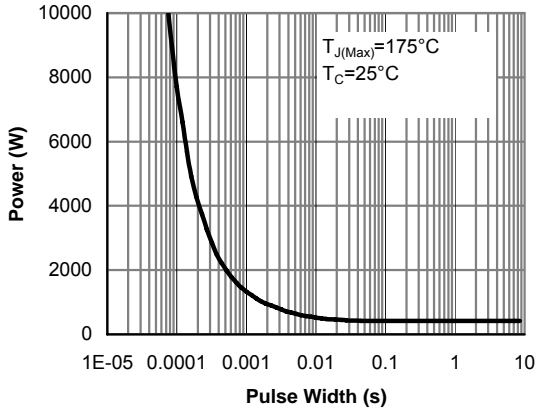

Figure 10: Single Pulse Power Rating Junction-to-Case for AOT474 (Note F)

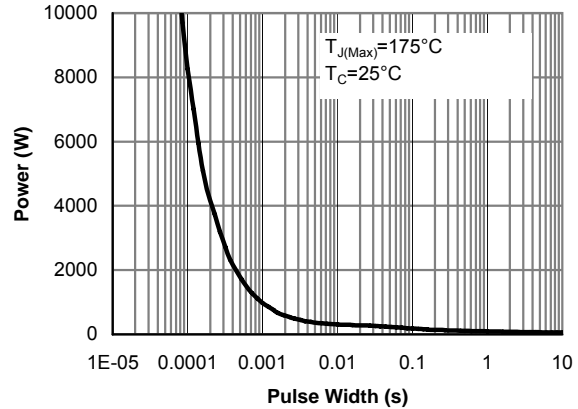

Figure 11: Single Pulse Power Rating Junction-to-Case for AOTF474 (Note F)

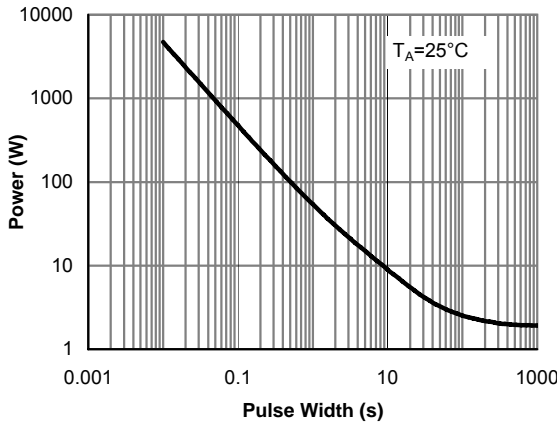

Figure 12: Single Pulse Power Rating Junction-to-Ambient for AOT474 (Note G)

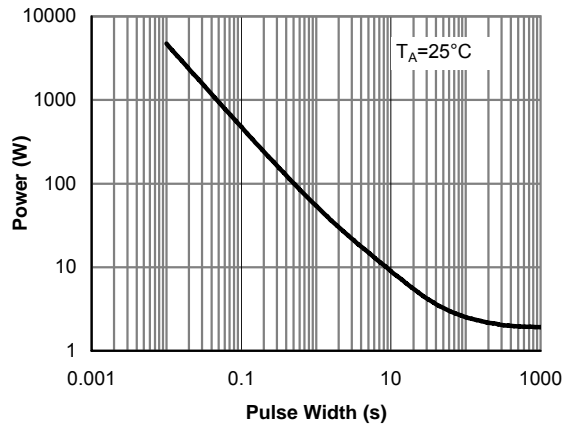

Figure 13: Single Pulse Power Rating Junction-to-Ambient for AOTF474 (Note G)

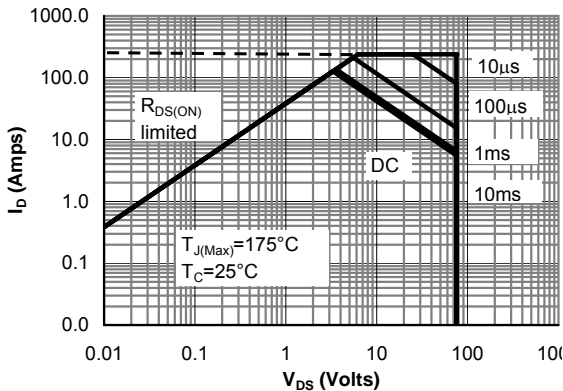

Figure 14: Maximum Forward Biased Safe Operating Area for AOT474 (Note F)

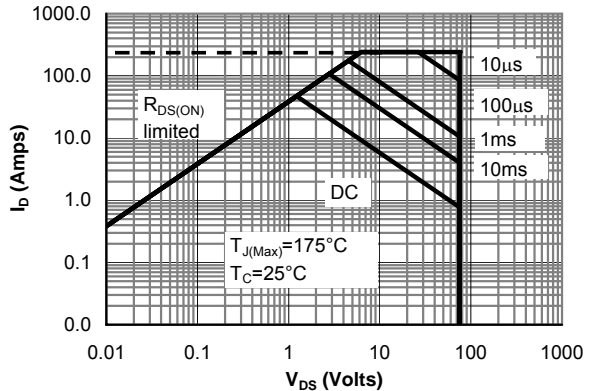

Figure 15: Maximum Forward Biased Safe Operating Area for AOTF474 (Note F)

TYPICAL ELECTRICAL AND THERMAL CHARACTERISTICS

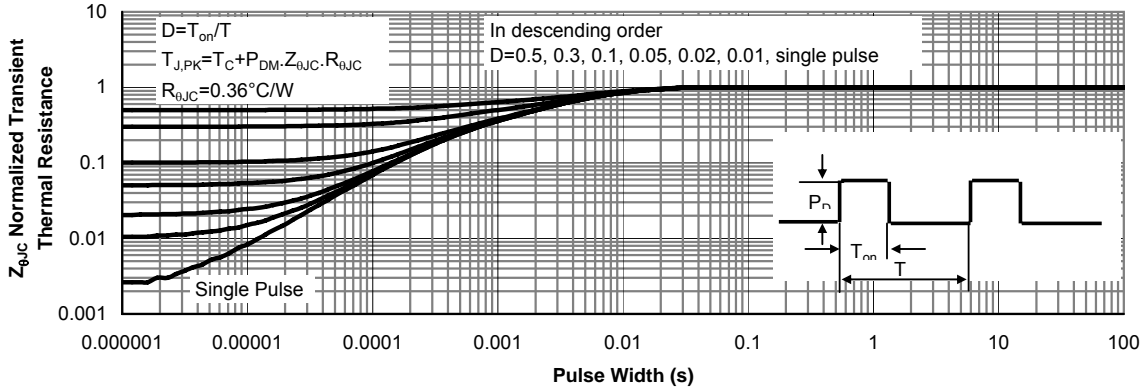

Figure 16: Normalized Maximum Transient Thermal Impedance for AOT474 (Note F)

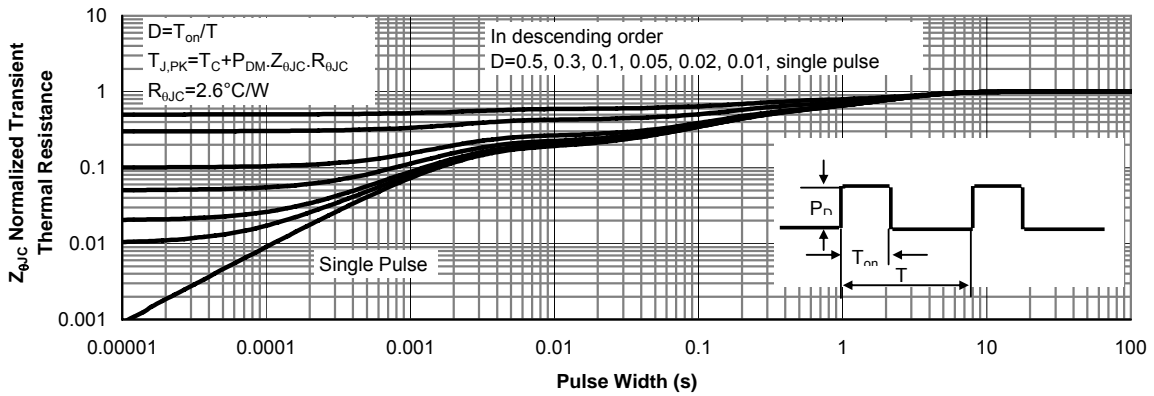
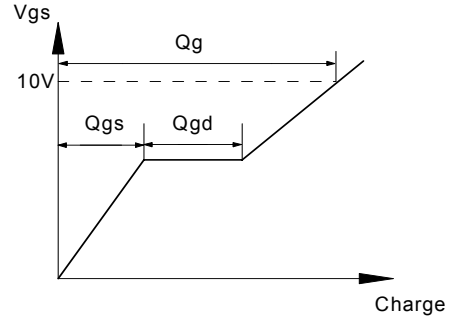
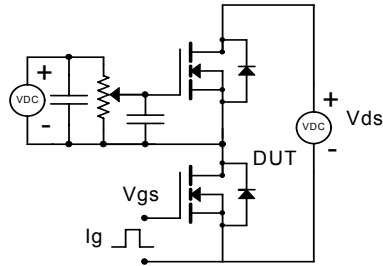
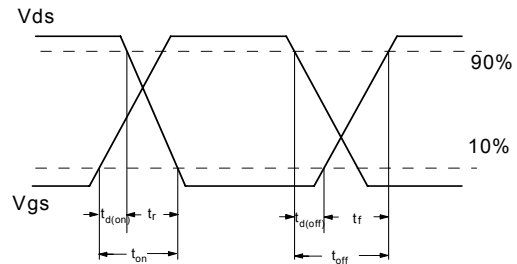
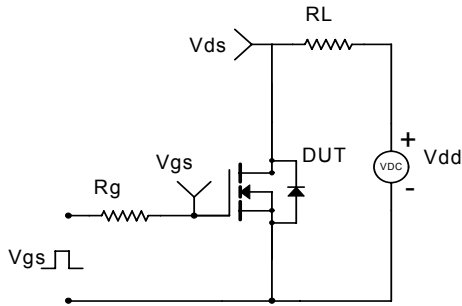

Figure 17: Normalized Maximum Transient Thermal Impedance for AOTF474 (Note F)

Gate Charge Test Circuit & Waveform



Resistive Switching Test Circuit & Waveforms



Unclamped Inductive Switching (UIS) Test Circuit & Waveforms

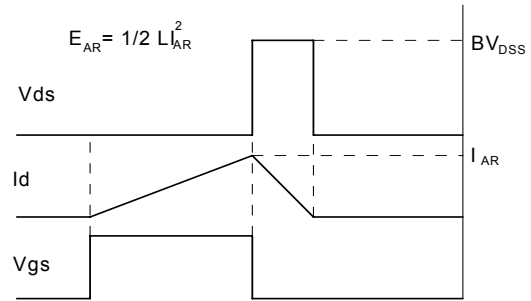
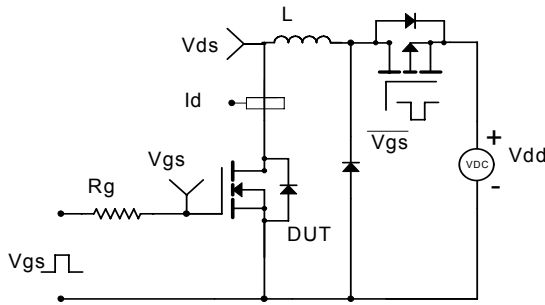

Diode Recovery Test Circuit & Waveforms

