

74x Series Chip Resistor Arrays

Features

- AEC-Q200 Compliant [See Ordering Information]
- Low Cost Thick Film Technology
- Leadless Surface Mount Construction
- Concave or Convex Terminations
- Solder Coated Nickel Barrier Pads
- Isolated and Bussed Circuit Configurations
- Improved TCR Tracking vs. Discrete Resistors
- Fewer Placements Than Discrete Components
- Tape and Reel Packaging



RoHS Compliant in Accordance with EU Directive 2011/65/EU and 2015/863

- Lead-Free Termination Finish
- Exemption 7(c)-I, Electrical and electronic components containing lead [Pb] in glass

Applications

- Data Communications
- Image Processing
- Medical Equipment
- Networking
- Pull-Up/Pull-Down Logic Gates
- DDR SDRAM, MDDR, DRAM
- Portable Test Equipment
- Low Profile High Density Designs

Description

74x Series Chip Arrays are single packaged devices containing an array of homogeneous resistor elements. Arrays are typically used for convenience when several resistors occupy the same area in a layout. Multiple package sizes and circuit configurations help save placement costs by reducing application component count.

Ordering Information

Model			Resistor Value	Resistor Tolerance	RoHS Compliant
741X083			103	J	P
Package Code	Package Code	Package Code		Code	Termination
740X043 [AEC-Q200]	742C043 [AEC-Q200]	745X102 [AEC-Q200]		J	±5% ¹
741X043 [AEC-Q200]	742X083 [AEC-Q200]	742C163		F	±1% ^{2,3}
741X083 [AEC-Q200]	742C083 [AEC-Q200]	745C101		X	Zero Ohm
741C083 [AEC-Q200]	744X083 [AEC-Q200]	745C102			
741X163 [AEC-Q200]	745X101 [AEC-Q200]	746X101			
			Code	Resistor Value *	
			103	10k ohm	
					Code
					P

* See Addendum for Standard EIA Values and Codes

Notes:

- Standard tolerance is ±5% and available for 740 thru 746 package codes; 3-digit resistor codes.
- Optional tolerance at ±1% is available for 741 thru 744 package codes, 4-digit resistor codes; except 742C043 and 742C163 [±5% only].
- Consult factory for availability with 740X043 package code.

**Not all performance combinations and resistor values may be available.
Contact your local CTS Representative or CTS Customer Service for availability.**

This product is specified for use only in standard commercial applications. Supplier disclaims all express and implied warranties and liability in connection with any use of this product in any non-commercial applications or in any application that may expose the product to conditions that are outside of the tolerances provided in its specification.



Ordering Information

Part Number Examples

Tolerance / Value	3-Digit Code J [±5%]	4-Digit Code F [±1%]
10 Ohms	742C083100JP	742C08310R0FP
49.9 Ohms	Not Available	742C08349R9FP
120 Ohms	742C083121JP	742C0831200FP
1k Ohms	742C083102JP	742C0831001FP
68k Ohms	742C083683JP	742C0836802FP

3-Digit Resistor Code [±5% tolerance only.]

1st and 2nd digits are resistor, 3rd digit is number of zeros.

Ex. 102 = 1,000 ohm = 1k ohm

Ex. 683 = 68,000 ohm = 68k ohm

4-Digit Resistor Code [±1% tolerance only.]

First three digits are resistor value, 4th digit is number of zeros.

Ex. 1001 = 1,000 ohm = 1k ohm

Ex. 6802 = 68,000 ohm = 68k ohm

Resistance Values <100 Ohms

“R” indicates decimal for values less than 100 ohm.

Ex. 49R9 = 49.9 ohm

Electrical & Environmental Specifications

Operating Conditions

Package	PCB Area Per Resistor [Sq. Inch]	Circuit Type	Resistance Range [ohm]	Resistance Tolerance [%] ¹	Operating Temperature Range	Temperature Coefficient	+70°C Power Per Resistor ² [Watts]	Maximum Operating Voltage
740	0.0008	Isolated	10 - 1M	±5% Std. or	-55°C to +125°C	±200ppm/°C	0.031	12.5V
741	0.0015	Isolated	10 - 1M					
742	0.0037	Isolated	10 - 1M	0.5 ohm [whichever is greater]			0.063	50V
744	0.0094	Isolated	10 - 1M					
745X	0.0058	Bussed	10 - 330k					
745C	0.0058	Bussed	10 - 1M			±250ppm/°C	0.063	50V
746	0.0013	Bussed	10 - 100k			±200ppm/°C	0.063	25V

1. See Ordering Information for other options available.

2. Total Rated Package Power equals total number of resistors times rated Power Per Resistor.

Operating Conditions – 0 ohm

Package	PCB Area Per Resistor [Sq. Inch]	Circuit Type	Resistance Range [ohm]	Current @ +70°C Max Per Element [A]	Surge Current Max <1 second [A]	Max Resistance [milliohm]
740	0.0008	Isolated	0.0	1.0	2.0	50
741	0.0015	Isolated				
742	0.0037	Isolated				
744	0.0094	Isolated				

1. Not available with 745, and 746 package codes.

Electrical & Environmental Specifications

Power Derating Curve – Typical

With the rated ambient temperature set to +70°C, the maximum power [maximum current for 0Ω product] at a temperature of no more than rated ambient temperature shall be equal to the rated power [rate current for 0Ω product]. The maximum power at a temperature exceeding the rated ambient temperature shall be a value determined by reducing the rated power according to the power reduction curve in the figure below.

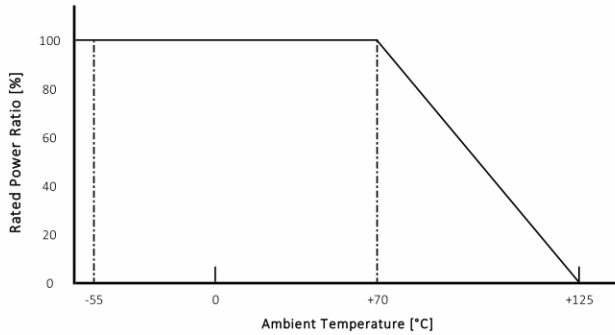

Rated Voltage

The rated voltage shall be the DC or AC [effective power frequency] voltage corresponding to the rated power and shall be determined with the formula shown below. If the determined rated voltage exceeds the maximum operating voltage specified in Operating Conditions table, the maximum operating voltage shall be the rated voltage.

$$E = \sqrt{P \times R}$$

E = Rated Voltage [V]
 P = Rated Power [W]
 R = Nominal Resistance [Ω]

Environmental Parameters

Test	Maximum Delta R [%]			Test Description
	740	741	742 - 746	
Thermal Cycle	1.00	1.00	1.00	5 cycles -55°C to +125°C
Short Time Overload	2.00	2.50	1.00	2½ times rated working voltage for 5 seconds
Moisture Resistance	2.00	5.00	2.00	240 hours @ 0.1 rated load; -10°C to +65°C, 90% RH
High Temperature Exposure	3.00	1.00	1.00	1,000 hours @ +125°C, no load
Load Life	3.00	5.00	2.00	1,000 hours @ +70°C, rated load
Resistance to Solder Heat	1.00	2.50	1.00	10 seconds @ +260°C solder
Resistance to Solvents	---	---	---	Isopropyl alcohol, Freon TMC
Solderability	---	---	---	RMA Flux, +230°C, 5 seconds dip, 95% coverage

Electrical & Environmental Specifications

Circuit Types [Schematics]

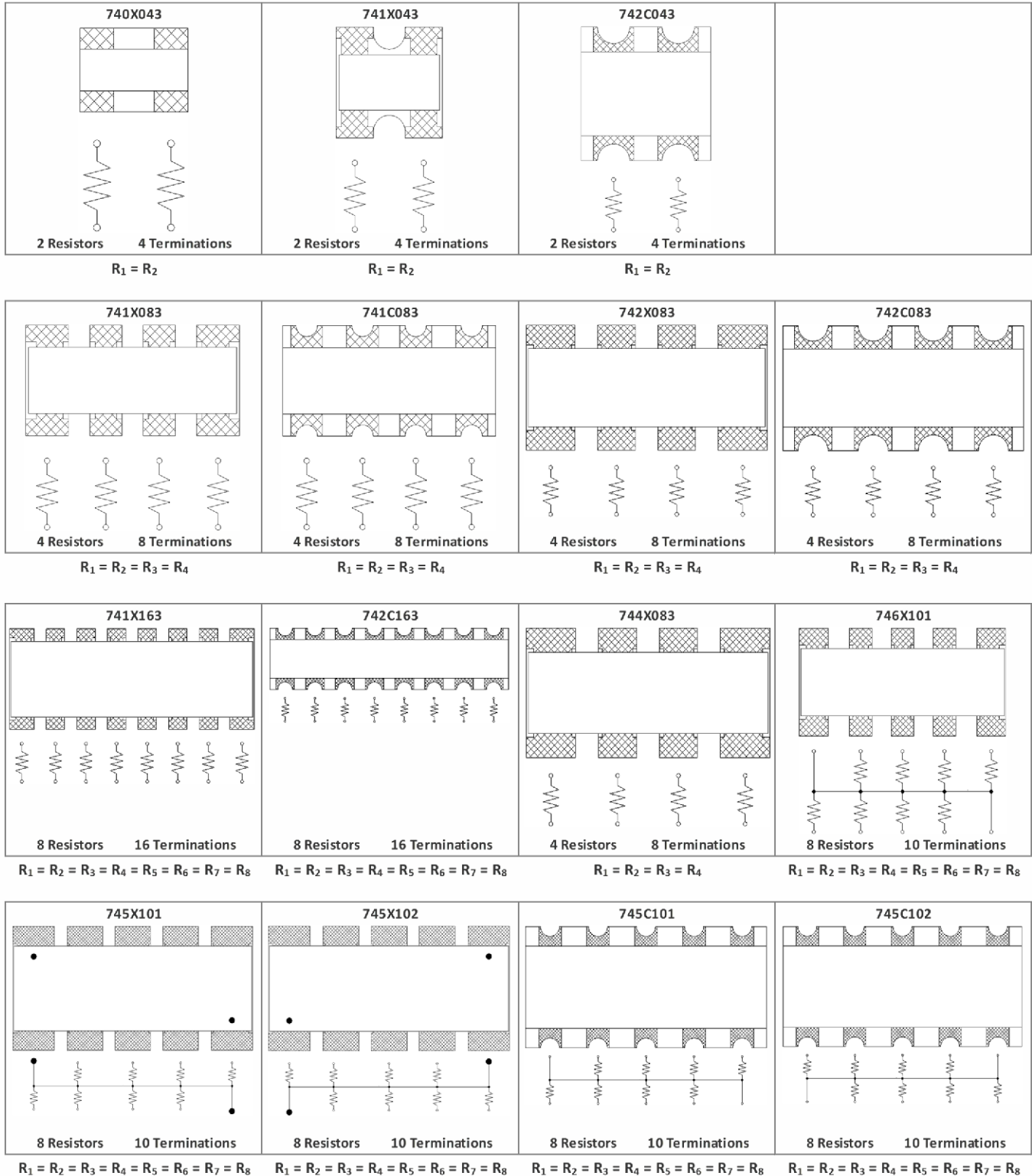

Mechanical Specifications

Package Drawing – Convex, Type X

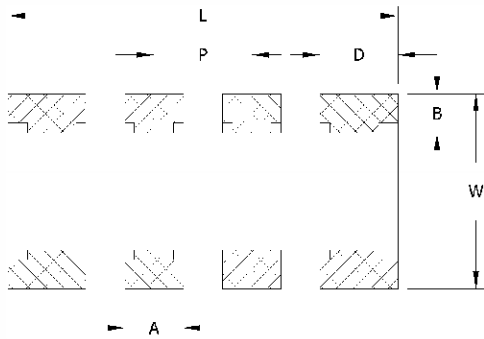

Package Drawing – Concave, Type C

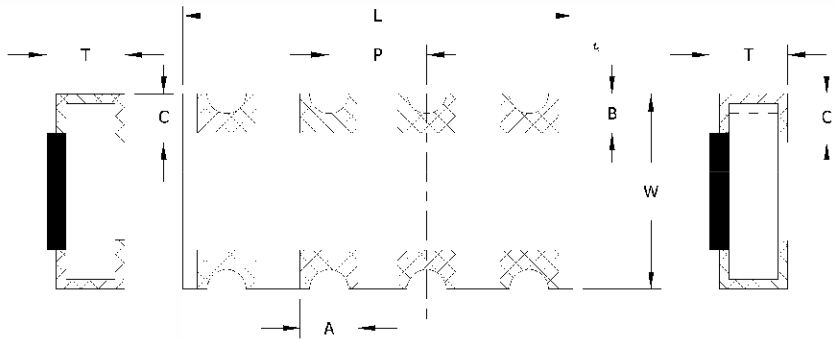

Notes

1. JEDEC termination code (e3). Barrier-plating is nickel [Ni] with Matte tin [Sn] finish.
2. Reflow conditions per JEDEC J-STD-020; +260°C maximum, 20 seconds.
3. MSL = 1.

Package Configuration/Dimensions

Package Code	Resistor Size/ Configuration	Termination Pads	# Resistors	Circuit Type	Dimensions [mm]							
					L	W	P [Typ.]	T	A	B	C	D
740X043	0201 X 2	4	2	Isolated	0.80 ±0.10	0.60 ±0.10	0.50	0.35 ±0.10	N/A	0.175 ±0.125	0.15 ±0.10	0.35 ±0.10
741X043	0402 X 2	4	2	Isolated	1.00 ±0.20	1.00 ±0.20	0.65	0.35 ±0.10	N/A	0.20 ±0.15	0.25 ±0.10	0.33 ±0.15
741X083	0402 X 4	8	4	Isolated	2.00 ±0.20	1.00 ±0.20	0.50	0.40 ±0.15	0.30 ±0.15	0.20 ±0.15	0.25 ±0.20	0.40 ±0.15
741C083	0402 X 4	8	4	Isolated	2.00 ±0.20	1.00 ±0.20	0.50	0.375 ±0.125	0.29 ±0.11	0.20 ±0.10	0.265 ±0.115	N/A
741X163	0602 X 8	16	8	Isolated	3.95 ±0.25	1.60 ±0.15	0.50	0.45 ±0.10	0.30 ±0.10	0.30 ±0.15	0.375 ±0.175	0.325 ±0.175
742C043	0603 X 2	4	2	Isolated	1.60 ±0.20	1.60 ±0.20	0.80	0.525 ±0.175	0.50 ±0.15	0.30 ±0.20	0.40 ±0.15	N/A
742X083	0603 X 4	8	4	Isolated	3.20 ±0.15	1.60 ±0.15	0.80	0.55 ±0.15	0.45 ±0.20	0.30 ±0.20	0.275 ±0.175	0.525 ±0.225
742C083	0603 X 4	8	4	Isolated	3.20 ±0.20	1.60 ±0.20	0.80	0.525 ±0.175	0.50 ±0.15	0.30 ±0.20	0.35 ±0.20	N/A
742C163	0603 X 8	16	8	Isolated	6.40 ±0.20	1.60 ±0.20	0.80	0.525 ±0.175	0.50 ±0.15	0.30 ±0.20	0.40 ±0.15	N/A
744X083	1206 X 4	8	4	Isolated	5.80 ±0.20	3.20 ±0.20	1.27	0.60 ±0.175	0.90 ±0.15	0.50 ±0.20	0.50 ±0.15	1.10 ±0.15
745C101	---	10	8	Bussed	6.40 ±0.20	3.10 ±0.20	1.27	0.575 ±0.125	0.60 ±0.15	0.50 ±0.30	0.55 ±0.30	N/A
745C102	---	10	8	Bussed	6.40 ±0.20	3.10 ±0.20	1.27	0.575 ±0.125	0.60 ±0.15	0.50 ±0.30	0.55 ±0.30	N/A
745X101	---	10	8	Bussed	6.40 ±0.20	3.20 ±0.20	1.27	0.60 ±0.10	0.95 ±0.20	0.50 ±0.15	0.50 ±0.15	1.10 ±0.15
745X102	---	10	8	Bussed	6.40 ±0.20	3.20 ±0.20	1.27	0.60 ±0.10	0.95 ±0.20	0.50 ±0.15	0.50 ±0.15	1.10 ±0.15
746X101	---	10	8	Bussed	3.20 ±0.20	1.60 ±0.15	0.64	0.60 ±0.10	0.35 ±0.05	0.30 ±0.15	0.35 ±0.15	0.45 ±0.05

Mechanical Specifications

Recommended Pad Layout

Package Code	Dimensions [mm]			
	A	B	C	D
740	0.90	0.30	0.30	0.50
741X043	1.80	0.50	0.30	0.67
741X083	1.80	0.50	0.30	0.50
741C083	1.80	0.50	0.30	0.50
741X163	1.80	0.50	0.30	0.50
742	2.60	0.80	0.45	0.80
744	3.90	2.20	0.71	1.27
745	3.90	1.60	0.90	1.27
746	2.60	0.80	0.35	0.64

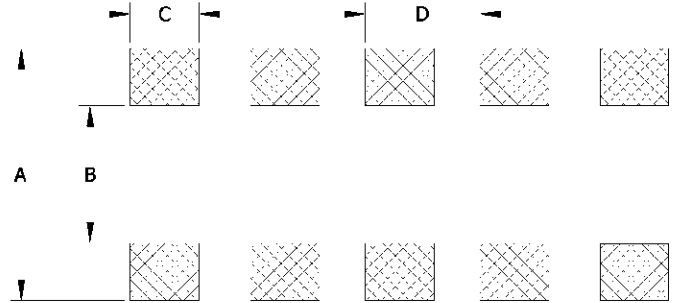

Marking Information

Package Code	J	F		Marking Color ¹
	Tolerance E-24 Value	Tolerance E-24 Value	Tolerance E-96 Value	
740X043	No Marking	-	-	-
741X043	No Marking	No Marking	No Marking	-
741X083	No Marking	No Marking	No Marking	-
	or 3-Digits	or 4-Digits	or 4-Digits	
741C083	No Marking	No Marking	No Marking	-
	or 3-Digits	or 3-Digits	or No Marking	
741X163	3-Digits	4-Digits	4-Digits	-
742C043 ²	3-Digits	3-Digits	4-Digits	White
		or 4-Digits	3-Digits	
742X083	3-Digits	or 4-Digits	4-Digits	White
742C083	3-Digits	or 4-Digits	4-Digits	White
742C163	3-Digits	4-Digits	4-Digits	White
744X083	3-Digits	4-Digits	4-Digits	White
745C101	3-Digits	-	-	White
745C102	3-Digits	-	-	Orange
745X101	3-Digits	-	-	-
745X102	3-Digits	-	-	-
746X101	3-Digits	-	-	-

1. May vary from indicated color.
2. Zero Ohm jumper may not have marking present.
3. Color of protective coating over resistors may vary.

10k ohm – 3-Digit

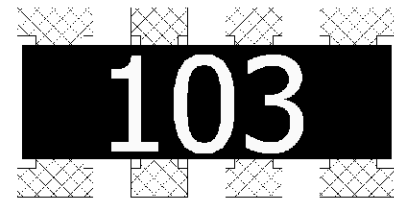

10k ohm – 4-Digit

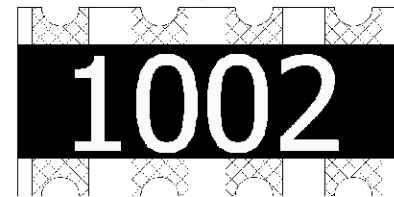



Packaging

Tape and Reel Information

REEL DIAMETER 7"	740X043	741X043 741C083 741X083	742C043 742C083 742X083	741X163	744X083 742C163	745C101 745C102	745X101 745X102	746X101
Parts Per Reel	10,000	10,000	5,000	5,000	4,000	4,000	4,000	5,000
Pitch	2mm	2mm	4mm	4mm	4mm	4mm	4mm	4mm
Carrier Width	8mm	8mm	8mm	12mm	12mm	12mm	12mm	8mm
Material	Paper	Paper	Paper	Paper	Plastic	Plastic	Plastic	Paper



Addendum

Standard EIA Codes and Resistor Values – E-24 [3-Digit Resistor Code for J Tolerances]

CODE	OHMS	CODE	OHMS	CODE	OHMS	CODE	OHMS	CODE	OHMS	CODE	OHMS
000X *	0	680	68	511	510	392	3.9k	303	30.0k	224	220k
100	10	750	75	561	560	432	4.3k	333	33.0k	244	240k
110	11	820	82	621	620	472	4.7k	363	36.0k	274	270k
120	12	910	91	681	680	512	5.1k	393	39.0k	304	300k
130	13	101	100	751	750	562	5.6k	433	43.0k	334	330k
150	15	111	110	821	820	622	6.2k	473	47.0k	364	360k
160	16	121	120	911	910	682	6.8k	513	51.0k	394	390k
180	18	131	130	102	1.0k	752	7.5k	563	56.0k	434	430k
200	20	151	150	112	1.1k	822	8.2k	623	62.0k	474	470k
220	22	161	160	122	1.2k	912	9.1k	683	68.0k	514	510k
240	24	181	180	132	1.3k	103	10.0k	753	75.0k	564	560k
270	27	201	200	152	1.5k	113	11.0k	823	82.0k	624	620k
300	30	221	220	162	1.6k	123	12.0k	913	91.0k	684	680k
330	33	241	240	182	1.8k	133	13.0k	104	100k	754	750k
360	36	271	270	202	2.0k	153	15.0k	114	110k	824	820k
390	39	301	300	222	2.2k	163	16.0k	124	120k	914	910k
430	43	331	330	242	2.4k	183	18.0k	134	130k	105	1M
470	47	361	360	272	2.7k	203	20.0k	154	150k		
510	51	391	390	302	3.0k	223	22.0k	164	160k		
560	56	431	430	332	3.3k	243	24.0k	184	180k		
620	62	471	470	362	3.6k	273	27.0k	204	200k		

* Includes tolerance code "X".



Addendum

Standard EIA Codes and Resistor Values – E-24 [4-Digit Resistor Code for F Tolerance]

CODE	OHMS	CODE	OHMS	CODE	OHMS	CODE	OHMS	CODE	OHMS	CODE	OHMS
000X *	0	68R0	68	5100	510	3901	3.9k	3002	30.0k	2203	220k
10R0	10	75R0	75	5600	560	4301	4.3k	3302	33.0k	2403	240k
11R0	11	82R0	82	6200	620	4701	4.7k	3602	36.0k	2703	270k
12R0	12	91R0	91	6800	680	5101	5.1k	3902	39.0k	3003	300k
13R0	13	1000	100	7500	750	5601	5.6k	4302	43.0k	3303	330k
15R0	15	1100	110	8200	820	6201	6.2k	4702	47.0k	3603	360k
16R0	16	1200	120	9100	910	6801	6.8k	5102	51.0k	3903	390k
18R0	18	1300	130	1001	1.0k	7501	7.5k	5602	56.0k	4303	430k
20R0	20	1500	150	1101	1.1k	8201	8.2k	6202	62.0k	4703	470k
22R0	22	1600	160	1201	1.2k	9101	9.1k	6802	68.0k	5103	510k
24R0	24	1800	180	1301	1.3k	1002	10.0k	7502	75.0k	5603	560k
27R0	27	2000	200	1501	1.5k	1102	11.0k	8202	82.0k	6203	620k
30R0	30	2200	220	1601	1.6k	1202	12.0k	9102	91.0k	6803	680k
33R0	33	2400	240	1801	1.8k	1302	13.0k	1003	100k	7503	750k
36R0	36	2700	270	2001	2.0k	1502	15.0k	1103	110k	8203	820k
39R0	39	3000	300	2201	2.2k	1602	16.0k	1203	120k	9103	910k
43R0	43	3300	330	2401	2.4k	1802	18.0k	1303	130k	1004	1M
47R0	47	3600	360	2701	2.7k	2002	20.0k	1503	150k		
51R0	51	3900	390	3001	3.0k	2202	22.0k	1603	160k		
56R0	56	4300	430	3301	3.3k	2402	24.0k	1803	180k		
62R0	62	4700	470	3601	3.6k	2702	27.0k	2003	200k		

* Includes tolerance code "X".



Addendum

Standard EIA Codes and Resistor Values – E-96¹ [4-Digit Resistor Code for F Tolerance]

CODE	OHMS	CODE	OHMS	CODE	OHMS	CODE	OHMS	CODE	OHMS	CODE	OHMS
000X *	0	26R1	26.1	69R8	69.8	1870	187	4990	499	1331	1.33k
10R0	10.0	26R7	26.7	71R5	71.5	1910	191	5110	511	1371	1.37k
10R2	10.2	27R4	27.4	73R2	73.2	1960	196	5230	523	1401	1.40k
10R5	10.5	28R0	28.0	75R0	75.0	2000	200	5360	536	1431	1.43k
10R7	10.7	28R7	28.7	76R8	76.8	2050	205	5490	549	1471	1.47k
11R0	11.0	29R4	29.4	78R7	78.7	2100	210	5620	562	1501	1.50k
11R3	11.3	30R1	30.1	80R6	80.6	2150	215	5760	576	1541	1.54k
11R5	11.5	30R9	30.9	82R5	82.5	2210	221	5900	590	1581	1.58k
11R8	11.8	31R6	31.6	84R5	84.5	2260	226	6040	604	1621	1.62k
12R1	12.1	32R4	32.4	86R6	86.6	2320	232	6190	619	1651	1.65k
12R4	12.4	33R2	33.2	88R7	88.7	2370	237	6340	634	1691	1.69k
12R7	12.7	34R0	34.0	90R9	90.9	2430	243	6490	649	1741	1.74k
13R0	13.0	34R8	34.8	93R1	93.1	2490	249	6650	665	1781	1.78k
13R3	13.3	35R7	35.7	95R3	95.3	2550	255	6810	681	1821	1.82k
13R7	13.7	36R5	36.5	97R6	97.6	2610	261	6980	698	1871	1.87k
14R0	14.0	37R4	37.4	1000	100	2670	267	7150	715	1911	1.91k
14R3	14.3	38R3	38.3	1020	102	2740	274	7320	732	1961	1.96k
14R7	14.7	39R2	39.2	1050	105	2800	280	7500	750	2001	2.00k
15R0	15.0	40R2	40.2	1070	107	2870	287	7680	768	2051	2.05k
15R4	15.4	41R2	41.2	1100	110	2940	294	7870	787	2101	2.10k
15R8	15.8	42R2	42.2	1130	113	3010	301	8060	806	2151	2.15k
16R2	16.2	43R2	43.2	1150	115	3090	309	8250	825	2211	2.21k
16R5	16.5	44R2	44.2	1180	118	3160	316	8450	845	2261	2.26k
16R9	16.9	45R3	45.3	1210	121	3240	324	8660	866	2321	2.32k
17R4	17.4	46R4	46.4	1240	124	3320	332	8870	887	2371	2.37k
17R8	17.8	47R5	47.5	1270	127	3400	340	9090	909	2431	2.43k
18R2	18.2	48R7	48.7	1300	130	3480	348	9310	931	2491	2.49k
18R7	18.7	49R9	49.9	1330	133	3570	357	9530	953	2551	2.55k
19R1	19.1	51R1	51.1	1370	137	3650	365	9760	976	2611	2.61k
19R6	19.6	52R3	52.3	1400	140	3740	374	1001	1.00k	2671	2.67k
20R0	20.0	53R6	53.6	1430	143	3830	383	1021	1.02k	2741	2.74k
20R5	20.5	54R9	54.9	1470	147	3920	392	1051	1.05k	2801	2.80k
21R0	21.0	56R2	56.2	1500	150	4020	402	1071	1.07k	2871	2.87k
21R5	21.5	57R6	57.6	1540	154	4120	412	1101	1.10k	2941	2.94k
22R1	22.1	59R0	59.0	1580	158	4220	422	1131	1.13k	3011	3.01k
22R6	22.6	60R4	60.4	1620	162	4320	432	1151	1.15k	3091	3.09k
23R2	23.2	61R9	61.9	1650	165	4420	442	1181	1.18k	3161	3.16k
23R7	23.7	63R4	63.4	1690	169	4530	453	1211	1.21k	3241	3.24k
24R3	24.3	64R9	64.9	1740	174	4640	464	1241	1.24k	3321	3.32k
24R9	24.9	66R5	66.5	1780	178	4750	475	1271	1.27k	3401	3.40k
25R5	25.5	68R1	68.1	1820	182	4870	487	1301	1.30k	3481	3.48k

1. Not all resistor values may be available. Please contact factory.

* Includes tolerance code "X".



Addendum

Standard EIA Codes and Resistor Values – E-96 ¹ [4-Digit Resistor Code for F Tolerance]

CODE	OHMS	CODE	OHMS	CODE	OHMS	CODE	OHMS	CODE	OHMS	CODE	OHMS
3571	3.57k	9311	9.31k	2432	24.3k	6342	63.4k	1653	165k	4323	432k
3651	3.65k	9531	9.53k	2492	24.9k	6492	64.9k	1693	169k	4423	442k
3741	3.74k	9761	9.76k	2552	25.5k	6652	66.5k	1743	174k	4533	453k
3831	3.83k	1002	10.0k	2612	26.1k	6812	68.1k	1783	178k	4643	464k
3921	3.92k	1022	10.2k	2672	26.7k	6982	69.8k	1823	182k	4753	475k
4021	4.02k	1052	10.5k	2742	27.4k	7152	71.5k	1873	187k	4873	487k
4121	4.12k	1072	10.7k	2802	28.0k	7322	73.2k	1913	191k	4993	499k
4221	4.22k	1102	11.0k	2872	28.7k	7502	75.0k	1963	196k	5113	511k
4321	4.32k	1132	11.3k	2942	29.4k	7682	76.8k	2003	200k	5233	523k
4421	4.42k	1152	11.5k	3012	30.1k	7872	78.7k	2053	205k	5363	536k
4531	4.53k	1182	11.8k	3092	30.9k	8062	80.6k	2103	210k	5493	549k
4641	4.64k	1212	12.1k	3162	31.6k	8252	82.5k	2153	215k	5623	562k
4751	4.75k	1242	12.4k	3242	32.4k	8452	84.5k	2213	221k	5763	576k
4871	4.87k	1272	12.7k	3322	33.2k	8662	86.6k	2263	226k	5903	590k
4991	4.99k	1302	13.0k	3402	34.0k	8872	88.7k	2323	232k	6043	604k
5111	5.11k	1332	13.3k	3482	34.8k	9092	90.9k	2373	237k	6193	619k
5231	5.23k	1372	13.7k	3572	35.7k	9312	93.1k	2433	243k	6343	634k
5361	5.36k	1402	14.0k	3652	36.5k	9532	95.3k	2493	249k	6493	649k
5491	5.49k	1432	14.3k	3742	37.4k	9762	97.6k	2553	255k	6653	665k
5621	5.62k	1472	14.7k	3832	38.3k	1003	100k	2613	261k	6813	681k
5761	5.76k	1502	15.0k	3922	39.2k	1023	102k	2673	267k	6983	698k
5901	5.90k	1542	15.4k	4022	40.2k	1053	105k	2743	274k	7153	715k
6041	6.04k	1582	15.8k	4122	41.2k	1073	107k	2803	280k	7323	732k
6191	6.19k	1622	16.2k	4222	42.2k	1103	110k	2873	287k	7503	750k
6341	6.34k	1652	16.5k	4322	43.2k	1133	113k	2943	294k	7683	768k
6491	6.49k	1692	16.9k	4422	44.2k	1153	115k	3013	301k	7873	787k
6651	6.65k	1742	17.4k	4532	45.3k	1183	118k	3093	309k	8063	806k
6811	6.81k	1782	17.8k	4642	46.4k	1213	121k	3163	316k	8253	825k
6981	6.98k	1822	18.2k	4752	47.5k	1243	124k	3243	324k	8453	845k
7151	7.15k	1872	18.7k	4872	48.7k	1273	127k	3323	332k	8663	866k
7321	7.32k	1912	19.1k	4992	49.9k	1303	130k	3403	340k	8873	887k
7501	7.50k	1962	19.6k	5112	51.1k	1333	133k	3483	348k	9093	909k
7681	7.68k	2002	20.0k	5232	52.3k	1373	137k	3573	357k	9313	931k
7871	7.87k	2052	20.5k	5362	53.6k	1403	140k	3653	365k	9533	953k
8061	8.06k	2102	21.0k	5492	54.9k	1433	143k	3743	374k	9763	976k
8251	8.25k	2152	21.5k	5622	56.2k	1473	147k	3833	383k	1004	1M
8451	8.45k	2212	22.1k	5762	57.6k	1503	150k	3923	392k		
8661	8.66k	2262	22.6k	5902	59.0k	1543	154k	4023	402k		
8871	8.87k	2322	23.2k	6042	60.4k	1583	158k	4123	412k		
9091	9.09k	2372	23.7k	6192	61.9k	1623	162k	4223	422k		

1. Not all resistor values may be available. Please contact factory.