

COMPLEMENTARY 60V ENHANCEMENT MODE MOSFET H-BRIDGE

ADVANCE TECHNOLOGY INFORMATION

Product Summary

Device	BV _{DSS}	R _{DS(ON)} max	I _D max T _A = +25°C
N-Channel	60V	0.3Ω @ V _{GS} = 10V	1.8A
		0.45Ω @ V _{GS} = 4.5V	1.4A
P-Channel	-60V	0.425Ω @ V _{GS} = -10V	-1.5A
		0.63Ω @ V _{GS} = -4.5V	-1.2A

Description

This new generation complementary MOSFET H-Bridge features low on-resistance achievable with low gate drive.

Applications

- DC Motor Control
- DC-AC Inverters

Features

- 2 x N + 2 x P Channels in a SOIC Package
- Low On-Resistance
- Low Input Capacitance
- Fast Switching Speed
- **Lead-Free Finish; RoHS Compliant (Notes 1 & 2)**
- **Halogen and Antimony Free. "Green" Device (Note 3)**

Mechanical Data

- Case: SM-8 (8 LEAD SOT223)
- Case Material: Molded Plastic, "Green" Molding Compound; UL Flammability Classification Rating 94V-0
- Moisture Sensitivity: Level 1 per J-STD-020
- Terminal Connections Indicator: See Diagram
- Terminals: Finish — Matte Tin Annealed over Copper Leadframe; Solderable per MIL-STD-202, Method 208 ③
- Weight: 0.117 grams (Approximate)

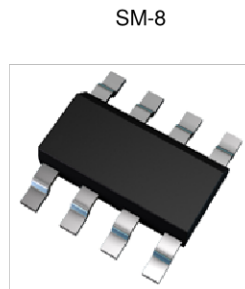

Top View

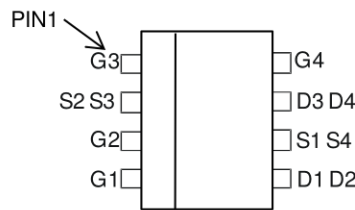

Top View Pin Configuration

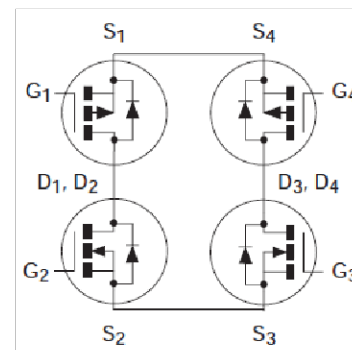

Internal Schematic

Ordering Information (Note 4)

Part Number	Reel Size	Tape Width	Quantity Per Reel
ZXMHC6A07T8TA	7"	12mm	1,000 units
ZXMHC6A07T8TC	13"	12mm	4,000 units

- Notes:
1. EU Directive 2002/95/EC (RoHS) & 2011/65/EU (RoHS 2) compliant. All applicable RoHS exemptions applied.
 2. See http://www.diodes.com/quality/lead_free.html for more information about Diodes Incorporated's definitions of Halogen- and Antimony-free, "Green" and Lead-free.
 3. Halogen- and Antimony-free "Green" products are defined as those which contain <900ppm bromine, <900ppm chlorine (<1500ppm total Br + Cl) and <1000ppm antimony compounds.
 4. For packaging details, go to our website at <http://www.diodes.com/products/packages.html>.

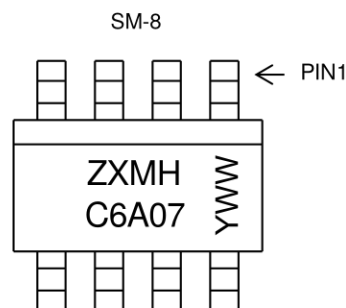
Marking Information

ZXMHC6A07 = Product Type Marking Code
 YWW = Date Code Marking
 Y or \bar{Y} = Last Digit of Year (ex: 5= 2015)
 WW or $\bar{W}W$ = Week Code (01~53)

Maximum Ratings (@T_A = +25°C, unless otherwise specified.)

Characteristic		Symbol	N-channel	P-channel	Units
Drain-Source Voltage		V _{DSS}	60	-60	V
Gate-Source Voltage		V _{GSS}	±20	±20	V
Continuous Drain Current, V _{GS} = 10V (Note 8)	Steady State	T _A = +25°C (Note 6)	1.8	-1.5	A
		T _A = +70°C (Note 6)	1.4	-1.2	
		T _A = +25°C (Note 5)	1.6	-1.3	
Maximum Body Diode Forward Current (Note 6)		I _S	2.3	-2.1	A
Pulsed Drain Current (Note 7)		I _{DM}	8.4	-7.2	A
Pulsed Source Current (Note 7)		I _{SM}	8.4	-7.2	A

Thermal Characteristics (@T_A = +25°C, unless otherwise specified.)

Characteristic		Symbol	Value	Units
Total Power Dissipation (Note 8)	T _A = +25°C (Note 5)	P _D	1.3	W
Linear Derating Factor			10.4	mW/°C
Total Power Dissipation (Note 8)	T _A = +25°C (Note 6)	P _D	1.7	W
Linear Derating Factor			13.6	mW/°C
Thermal Resistance, Junction to Ambient (Note 8)	Steady State (Note 5)	R _{θJA}	94.5	°C/W
	Steady State (Note 6)		73.3	°C/W
Operating and Storage Temperature Range		T _J , T _{STG}	-55 to +150	°C

- Notes:
5. For a device surface mounted on 50mm x 50mm x 1.6mm FR4 PCB with high coverage of single sided 2oz copper, in still air conditions, with the heat sink split into two equal areas one for each drain connection.
 6. For a device surface mounted on FR4 PCB measured at t ≤ 10 seconds.
 7. Repetitive rating 50mm x 50mm x 1.6mm FR4 PCB, D = 0.02, pulse width 300µs - pulse width limited by maximum junction temperature. Refer to Transient Thermal Impedance graph.
 8. For device with one active die.

ADVANCE INFORMATION

Typical Characteristics

ADVANCE INFORMATION

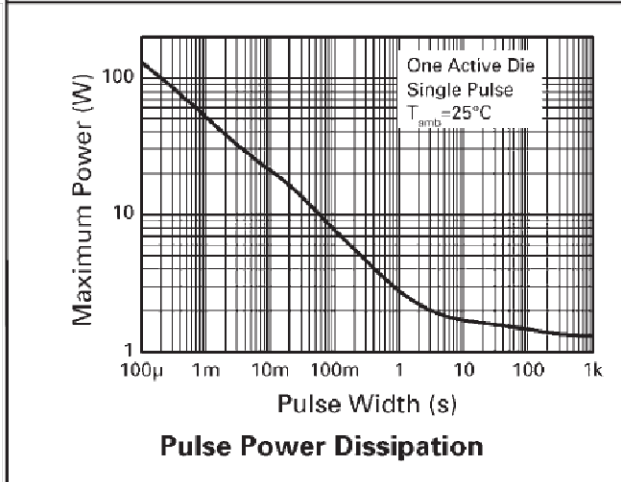
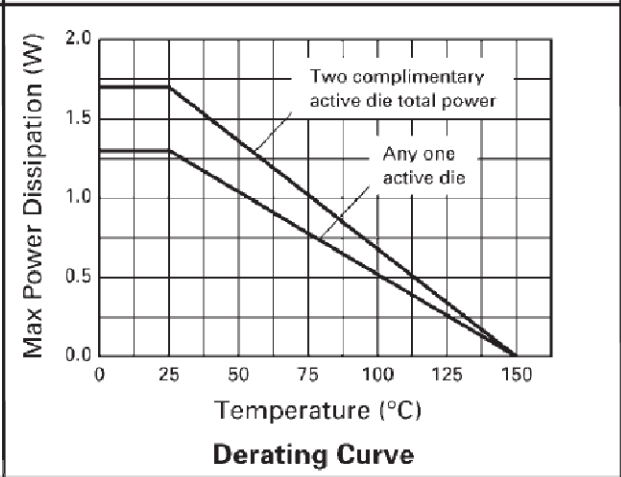
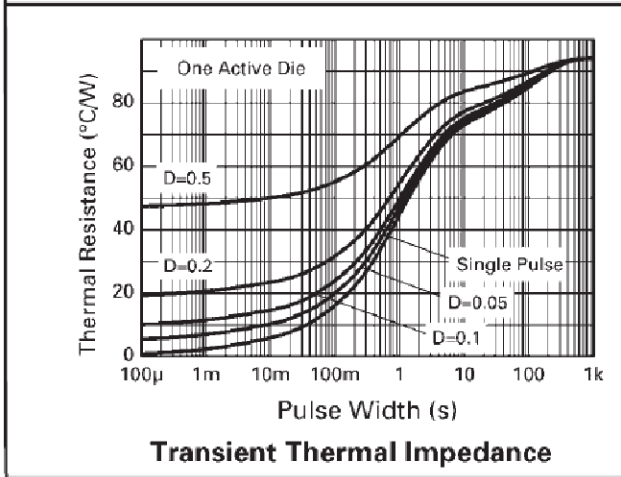
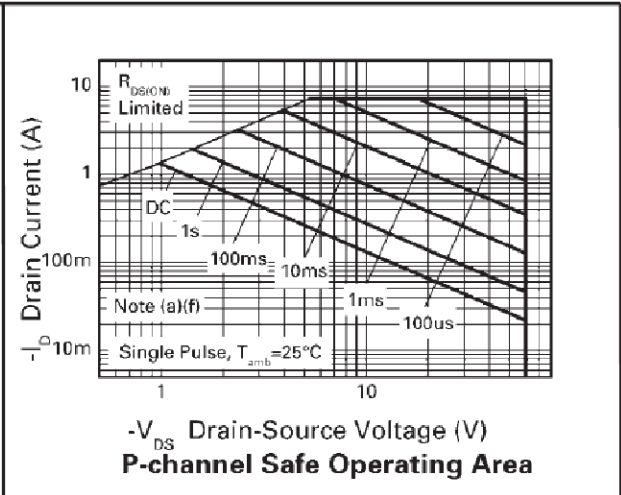
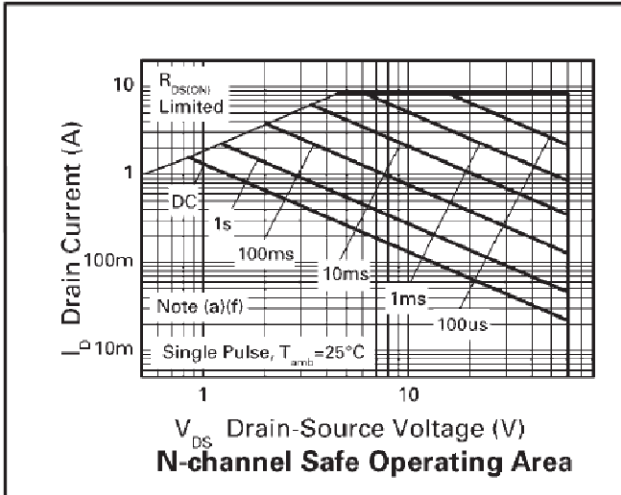

Electrical Characteristics N-CHANNEL (@T_A = +25°C, unless otherwise specified.)

Characteristic	Symbol	Min	Typ	Max	Unit	Test Condition
OFF CHARACTERISTICS (Note 10)						
Drain-Source Breakdown Voltage	BV _{DSS}	60	—	—	V	V _{GS} = 0V, I _D = 250μA
Zero Gate Voltage Drain Current	I _{DSS}	—	—	1.0	μA	V _{DS} = 60V, V _{GS} = 0V
Gate-Source Leakage	I _{GSS}	—	—	100	nA	V _{GS} = ±20V, V _{DS} = 0V
ON CHARACTERISTICS (Note 10)						
Gate Threshold Voltage	V _{GS(th)}	1.0	—	3.0	V	V _{DS} = V _{GS} , I _D = 250μA
Static Drain-Source On-Resistance (Note 9)	R _{DS(ON)}	—	—	0.3	Ω	V _{GS} = 10V, I _D = 1.8A
		—	—	0.45		V _{GS} = 4.5V, I _D = 1.3A
Forward Transfer Admittance (Notes 9 & 11)	g _{fs}	—	2.3	—	S	V _{DS} = 15V, I _D = 1.8A
Diode Forward Voltage (Note 9)	V _{SD}	—	0.85	0.95	V	T _J = +25°C, V _{GS} = 0V, I _S = 0.45A
DYNAMIC CHARACTERISTICS (Note 11)						
Input Capacitance	C _{iss}	—	166	—	pF	V _{DS} = 40V, V _{GS} = 0V, f = 1MHz
Output Capacitance	C _{oss}	—	19.5	—		
Reverse Transfer Capacitance	C _{rss}	—	8.7	—	nC	V _{DS} = 30V, I _D = 1.8A
Gate Charge (V _{GS} = -5.0V)	Q _g	—	1.65	—		
Total Gate Charge (V _{GS} = -10V)	Q _g	—	3.2	—		
Gate-Source Charge	Q _{gs}	—	0.67	—		
Gate-Drain Charge	Q _{gd}	—	0.82	—	ns	V _{DD} = 30V, V _{GS} = 10V, I _D = 1.8A, R _G = 6.0Ω
Turn-On Delay Time	t _{D(on)}	—	1.8	—		
Turn-On Rise Time	t _r	—	1.4	—		
Turn-Off Delay Time	t _{D(off)}	—	4.9	—		
Turn-Off Fall Time	t _f	—	2.0	—	ns	T _J = +25°C, I _S = 1.8A, di/dt = 100A/μs
Reverse Recovery Time	t _{rr}	—	20.5	—		
Reverse Recovery Charge	Q _{rr}	—	21.3	—	nC	

Electrical Characteristics P-CHANNEL (@T_A = +25°C, unless otherwise specified.)

Characteristic	Symbol	Min	Typ	Max	Unit	Test Condition
OFF CHARACTERISTICS (Note 10)						
Drain-Source Breakdown Voltage	BV _{DSS}	-60	—	—	V	V _{GS} = 0V, I _D = -250μA
Zero Gate Voltage Drain Current	I _{DSS}	—	—	-1.0	μA	V _{DS} = -60V, V _{GS} = 0V
Gate-Source Leakage	I _{GSS}	—	—	100	nA	V _{GS} = ±20V, V _{DS} = 0V
ON CHARACTERISTICS (Note 10)						
Gate Threshold Voltage	V _{GS(th)}	-1.0	—	—	V	V _{DS} = V _{GS} , I _D = -250μA
Static Drain-Source On-Resistance (Note 9)	R _{DS(ON)}	—	—	0.425	Ω	V _{GS} = -10V, I _D = -0.9A
		—	—	0.63		V _{GS} = -4.5V, I _D = -0.8A
Forward Transfer Admittance (Notes 9 & 11)	g _{fs}	—	1.8	—	S	V _{DS} = -15V, I _D = -0.9A
Diode Forward Voltage (Note 9)	V _{SD}	—	-0.85	-0.95	V	T _J = +25°C, V _{GS} = 0V, I _S = -0.8A
DYNAMIC CHARACTERISTICS (Note 11)						
Input Capacitance	C _{iss}	—	233	—	pF	V _{DS} = -30V, V _{GS} = 0V, f = 1MHz
Output Capacitance	C _{oss}	—	17.4	—	pF	
Reverse Transfer Capacitance	C _{rss}	—	9.6	—	pF	V _{DS} = -30V, I _D = -0.9A,
Gate Charge (V _{GS} = -5.0V)	Q _g	—	2.4	—	nC	
Total Gate Charge (V _{GS} = -10V)	Q _g	—	5.1	—	nC	
Gate-Source Charge	Q _{gs}	—	0.7	—	nC	
Gate-Drain Charge	Q _{gd}	—	0.7	—	nC	V _{DD} = -30V, V _{GS} = -10V, R _G = 6.0Ω, I _D = -1.0A
Turn-On Delay Time	t _{D(on)}	—	1.6	—	ns	
Turn-On Rise Time	t _r	—	2.3	—	ns	
Turn-Off Delay Time	t _{D(off)}	—	13	—	ns	
Turn-Off Fall Time	t _f	—	5.8	—	ns	T _J = +25°C, I _S = -0.9A, di/dt = 100A/μs
Reverse Recovery Time	t _{rr}	—	22.6	—	ns	
Reverse Recovery Charge	Q _{rr}	—	23.2	—	nC	

Notes: 9. Measured under pulsed conditions. Width ≤ 300μs. Duty cycle ≤ 2%.
 10. Short duration pulse test used to minimize self-heating effect.
 11. Guaranteed by design. Not subject to product testing.

ADVANCE INFORMATION

Typical Characteristics (N-Channel)

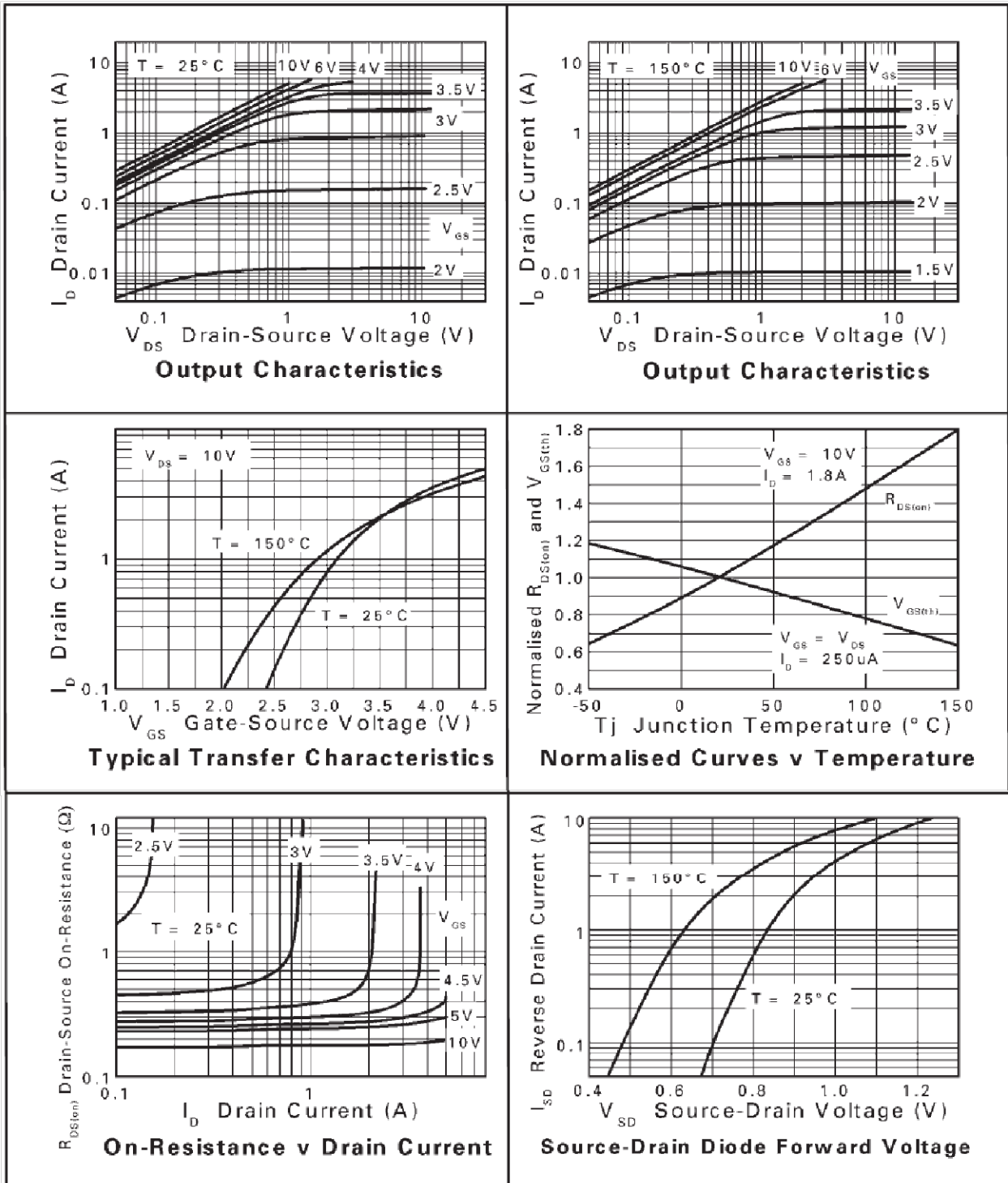

ADVANCE INFORMATION

Typical Characteristics (N-Channel)

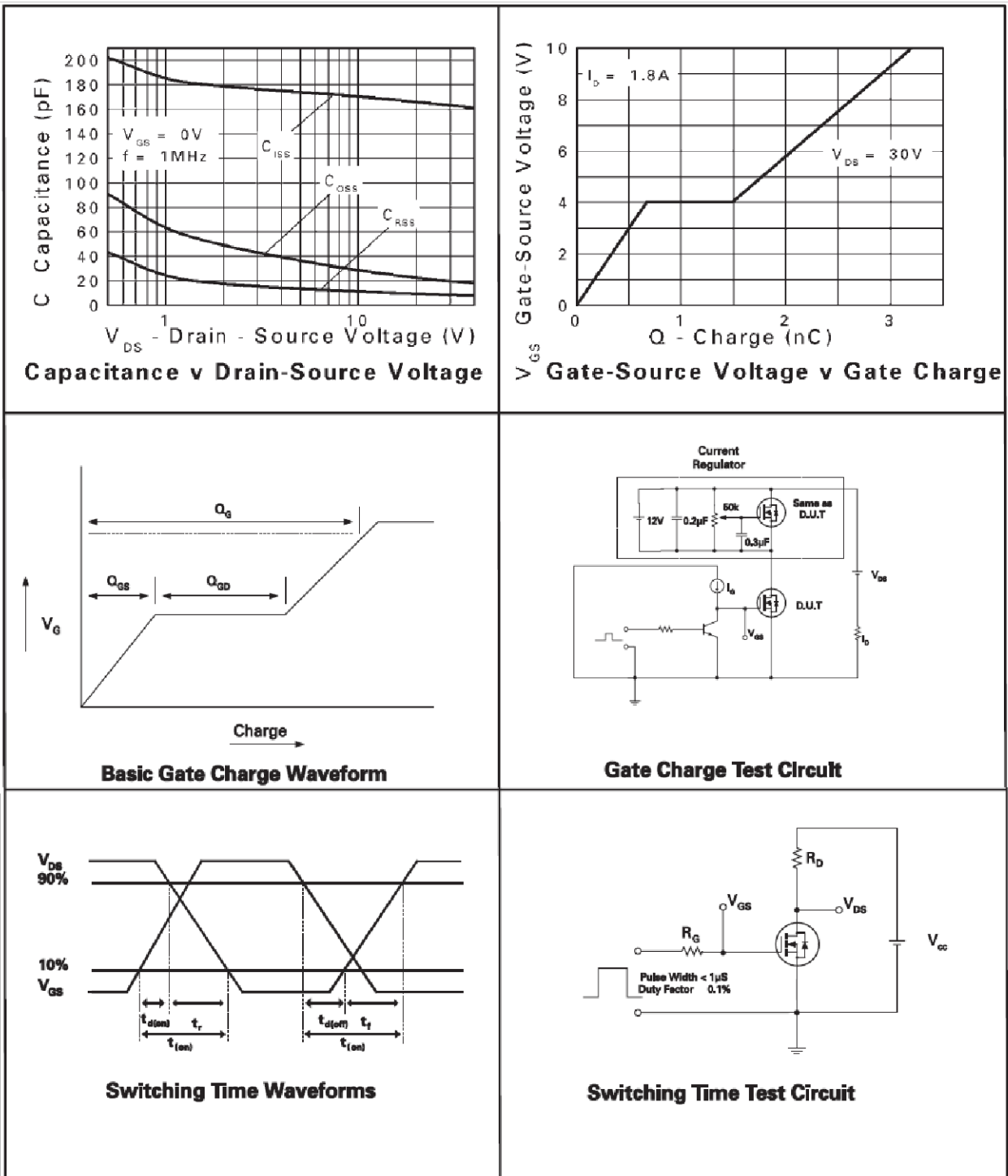

ADVANCE TECHNOLOGY INFORMATION

Typical Characteristics (P-Channel)

ADVANCE INFORMATION

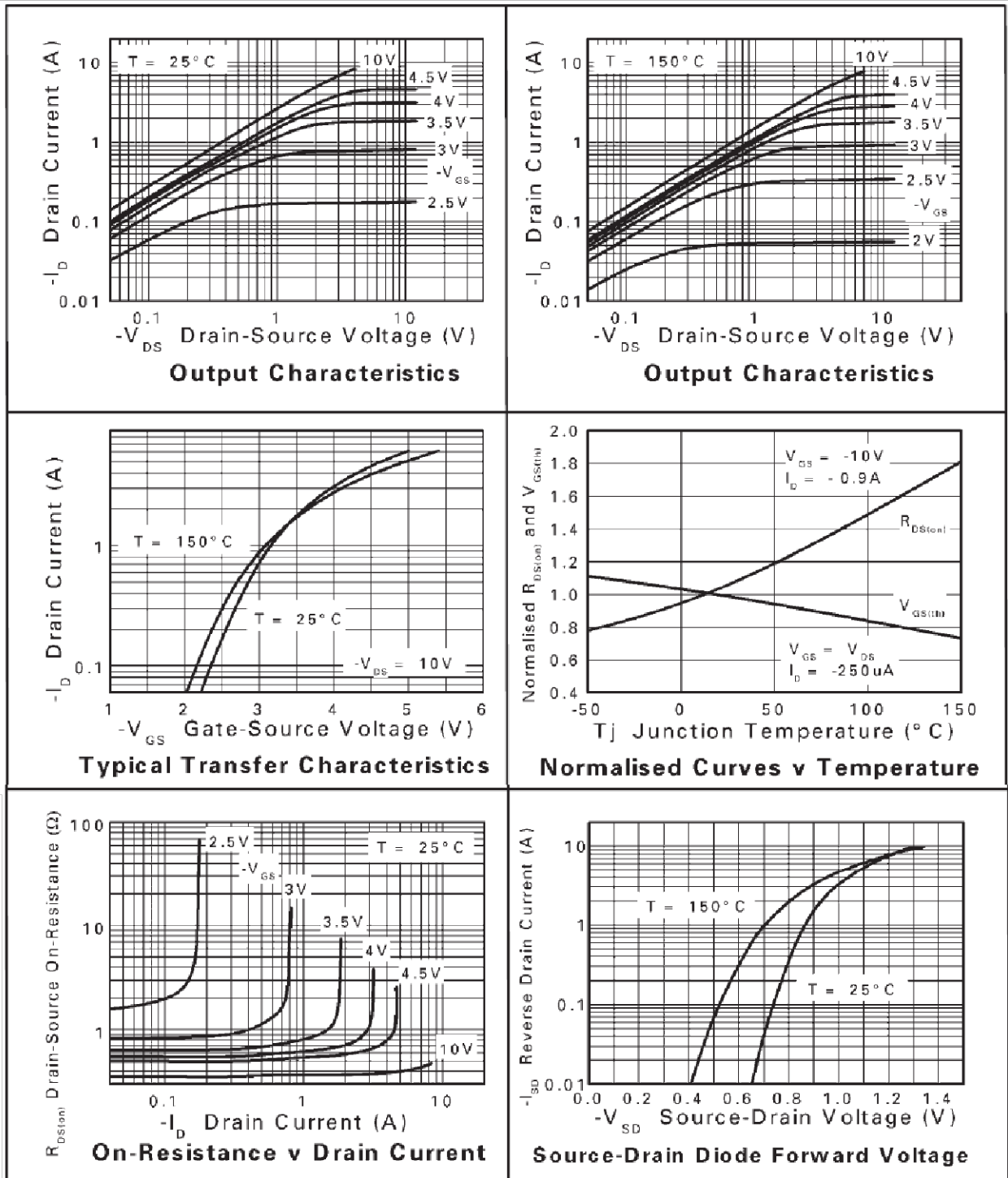

Typical Characteristics (P-Channel)

ADVANCE INFORMATION

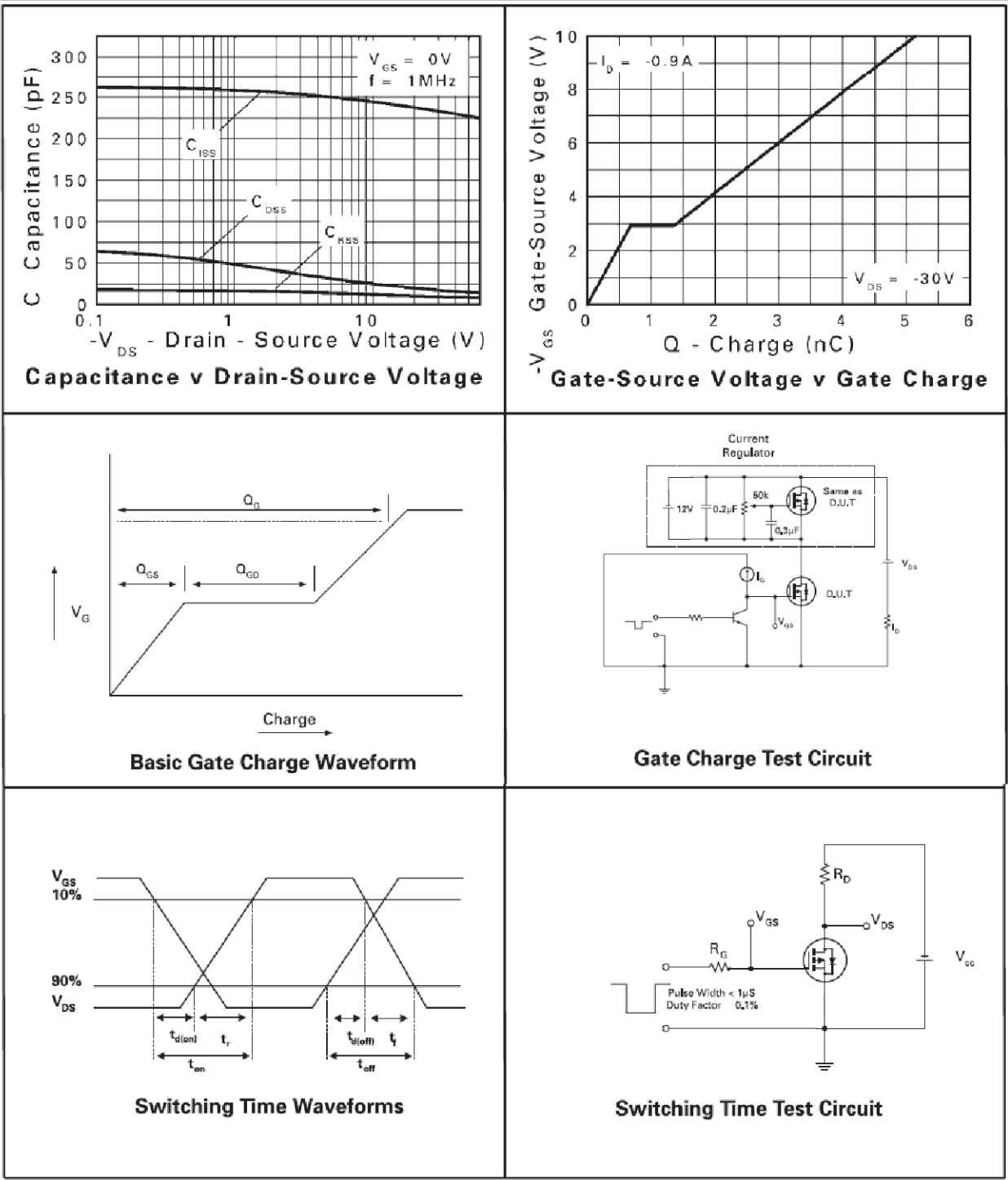

Package Outline Dimensions

Please see AP02002 at <http://www.diodes.com/datasheets/ap02002.pdf> for the latest version.

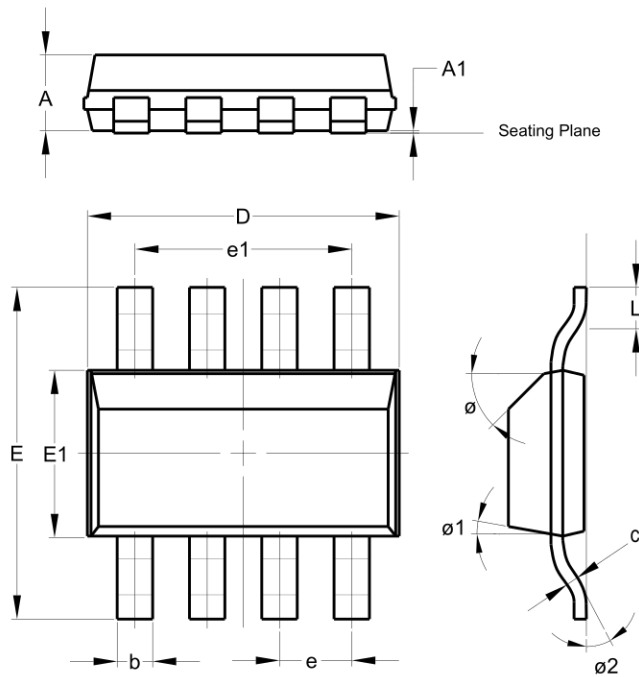

SM-8			
Dim	Min	Max	Typ
A	--	1.70	1.60
A1	0.02	0.10	0.04
b	0.70	0.90	0.80
c	0.24	0.32	0.28
D	6.30	6.70	6.60
e	1.53 REF		
e1	4.59 REF		
E	6.70	7.30	7.00
E1	3.30	3.70	3.50
L	0.75	1.00	0.90
ø	--	--	45°
ø1	--	15°	--
ø2	--	--	10°
All Dimensions in mm			

ADVANCE TECHNOLOGY INFORMATION

Suggested Pad Layout

Please see AP02001 at <http://www.diodes.com/datasheets/ap02001.pdf> for the latest version.

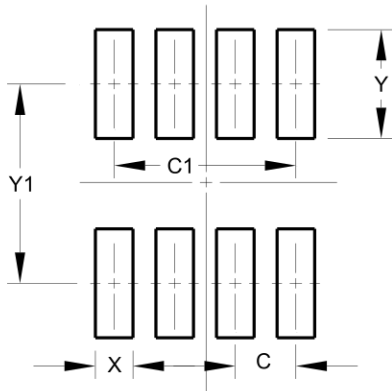

Dimensions	Value (in mm)
C	1.52
C1	4.60
X	0.95
Y	2.80
Y1	6.80

IMPORTANT NOTICE

DIODES INCORPORATED MAKES NO WARRANTY OF ANY KIND, EXPRESS OR IMPLIED, WITH REGARDS TO THIS DOCUMENT, INCLUDING, BUT NOT LIMITED TO, THE IMPLIED WARRANTIES OF MERCHANTABILITY AND FITNESS FOR A PARTICULAR PURPOSE (AND THEIR EQUIVALENTS UNDER THE LAWS OF ANY JURISDICTION).

Diodes Incorporated and its subsidiaries reserve the right to make modifications, enhancements, improvements, corrections or other changes without further notice to this document and any product described herein. Diodes Incorporated does not assume any liability arising out of the application or use of this document or any product described herein; neither does Diodes Incorporated convey any license under its patent or trademark rights, nor the rights of others. Any Customer or user of this document or products described herein in such applications shall assume all risks of such use and will agree to hold Diodes Incorporated and all the companies whose products are represented on Diodes Incorporated website, harmless against all damages.

Diodes Incorporated does not warrant or accept any liability whatsoever in respect of any products purchased through unauthorized sales channel. Should Customers purchase or use Diodes Incorporated products for any unintended or unauthorized application, Customers shall indemnify and hold Diodes Incorporated and its representatives harmless against all claims, damages, expenses, and attorney fees arising out of, directly or indirectly, any claim of personal injury or death associated with such unintended or unauthorized application.

Products described herein may be covered by one or more United States, international or foreign patents pending. Product names and markings noted herein may also be covered by one or more United States, international or foreign trademarks.

This document is written in English but may be translated into multiple languages for reference. Only the English version of this document is the final and determinative format released by Diodes Incorporated.

LIFE SUPPORT

Diodes Incorporated products are specifically not authorized for use as critical components in life support devices or systems without the express written approval of the Chief Executive Officer of Diodes Incorporated. As used herein:

A. Life support devices or systems are devices or systems which:

1. are intended to implant into the body, or
2. support or sustain life and whose failure to perform when properly used in accordance with instructions for use provided in the labeling can be reasonably expected to result in significant injury to the user.

B. A critical component is any component in a life support device or system whose failure to perform can be reasonably expected to cause the failure of the life support device or to affect its safety or effectiveness.

Customers represent that they have all necessary expertise in the safety and regulatory ramifications of their life support devices or systems, and acknowledge and agree that they are solely responsible for all legal, regulatory and safety-related requirements concerning their products and any use of Diodes Incorporated products in such safety-critical, life support devices or systems, notwithstanding any devices- or systems-related information or support that may be provided by Diodes Incorporated. Further, Customers must fully indemnify Diodes Incorporated and its representatives against any damages arising out of the use of Diodes Incorporated products in such safety-critical, life support devices or systems.

Copyright © 2015, Diodes Incorporated

www.diodes.com

ADVANCE TECHNOLOGY
INFORMATION