

## FDV301N Digital FET , N-Channel

### General Description

This N-Channel logic level enhancement mode field effect transistor is produced using Fairchild's proprietary, high cell density, DMOS technology. This very high density process is especially tailored to minimize on-state resistance. This device has been designed especially for low voltage applications as a replacement for digital transistors. Since bias resistors are not required, this one N-channel FET can replace several different digital transistors, with different bias resistor values.

### Features

- 25 V, 0.22 A continuous, 0.5 A Peak.  
 $R_{DS(ON)} = 5 \Omega @ V_{GS} = 2.7 V$   
 $R_{DS(ON)} = 4 \Omega @ V_{GS} = 4.5 V.$
- Very low level gate drive requirements allowing direct operation in 3V circuits.  $V_{GS(th)} < 1.06V.$
- Gate-Source Zener for ESD ruggedness. >6kV Human Body Model
- Replace multiple NPN digital transistors with one DMOS FET.



Mark:301

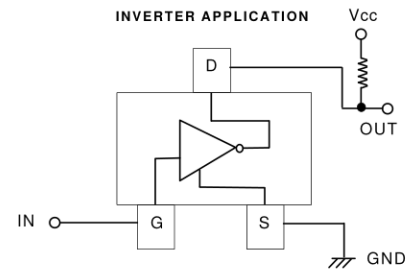
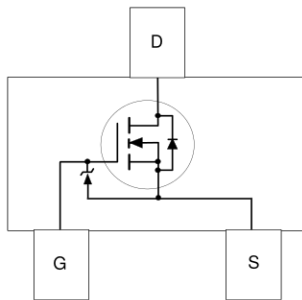
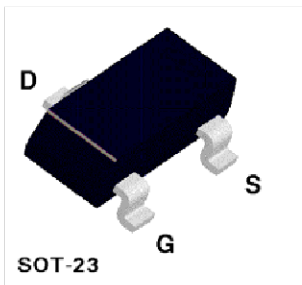

### Absolute Maximum Ratings $T_A = 25^\circ C$ unless other wise noted

| Symbol            | Parameter                                                                       | FDV301N    | Units      |
|-------------------|---------------------------------------------------------------------------------|------------|------------|
| $V_{DSS}, V_{CC}$ | Drain-Source Voltage, Power Supply Voltage                                      | 25         | V          |
| $V_{GSS}, V_I$    | Gate-Source Voltage, $V_{IN}$                                                   | 8          | V          |
| $I_D, I_O$        | Drain/Output Current - Continuous                                               | 0.22       | A          |
|                   |                                                                                 | 0.5        |            |
| $P_D$             | Maximum Power Dissipation                                                       | 0.35       | W          |
| $T_J, T_{STG}$    | Operating and Storage Temperature Range                                         | -55 to 150 | $^\circ C$ |
| ESD               | Electrostatic Discharge Rating MIL-STD-883D Human Body Model (100pf / 1500 Ohm) | 6.0        | kV         |

### THERMAL CHARACTERISTICS

|                 |                                         |     |              |
|-----------------|-----------------------------------------|-----|--------------|
| $R_{\theta JA}$ | Thermal Resistance, Junction-to-Ambient | 357 | $^\circ C/W$ |
|-----------------|-----------------------------------------|-----|--------------|

### Inverter Electrical Characteristics ( $T_A = 25^\circ\text{C}$ unless otherwise noted)

| Symbol       | Parameter                         | Conditions                                   | Min | Typ | Max | Units         |
|--------------|-----------------------------------|----------------------------------------------|-----|-----|-----|---------------|
| $I_{O(off)}$ | Zero Input Voltage Output Current | $V_{CC} = 20\text{ V}, V_I = 0\text{ V}$     |     |     | 1   | $\mu\text{A}$ |
| $V_{I(off)}$ | Input Voltage                     | $V_{CC} = 5\text{ V}, I_O = 10\ \mu\text{A}$ |     |     | 0.5 | V             |
| $V_{I(on)}$  |                                   | $V_O = 0.3\text{ V}, I_O = 0.005\text{ A}$   | 1   |     |     | V             |
| $R_{O(on)}$  | Output to Ground Resistance       | $V_I = 2.7\text{ V}, I_O = 0.2\text{ A}$     |     | 4   | 5   | $\Omega$      |

### Electrical Characteristics ( $T_A = 25^\circ\text{C}$ unless otherwise noted)

| Symbol | Parameter | Conditions | Min | Typ | Max | Units |
|--------|-----------|------------|-----|-----|-----|-------|
|--------|-----------|------------|-----|-----|-----|-------|

#### OFF CHARACTERISTICS

|                              |                                     |                                                                         |    |    |     |                            |
|------------------------------|-------------------------------------|-------------------------------------------------------------------------|----|----|-----|----------------------------|
| $BV_{DSS}$                   | Drain-Source Breakdown Voltage      | $V_{GS} = 0\text{ V}, I_D = 250\ \mu\text{A}$                           | 25 |    |     | V                          |
| $\Delta BV_{DSS}/\Delta T_J$ | Breakdown Voltage Temp. Coefficient | $I_D = 250\ \mu\text{A}$ , Referenced to $25^\circ\text{C}$             |    | 25 |     | $\text{mV}/^\circ\text{C}$ |
| $I_{DSS}$                    | Zero Gate Voltage Drain Current     | $V_{DS} = 20\text{ V}, V_{GS} = 0\text{ V}$<br>$T_J = 55^\circ\text{C}$ |    |    | 1   | $\mu\text{A}$              |
|                              |                                     |                                                                         |    |    | 10  | $\mu\text{A}$              |
| $I_{GSS}$                    | Gate - Body Leakage Current         | $V_{GS} = 8\text{ V}, V_{DS} = 0\text{ V}$                              |    |    | 100 | nA                         |

#### ON CHARACTERISTICS (Note)

|                                |                                          |                                                                          |      |      |      |                            |
|--------------------------------|------------------------------------------|--------------------------------------------------------------------------|------|------|------|----------------------------|
| $\Delta V_{GS(th)}/\Delta T_J$ | Gate Threshold Voltage Temp. Coefficient | $I_D = 250\ \mu\text{A}$ , Referenced to $25^\circ\text{C}$              |      | -2.1 |      | $\text{mV}/^\circ\text{C}$ |
| $V_{GS(th)}$                   | Gate Threshold Voltage                   | $V_{DS} = V_{GS}, I_D = 250\ \mu\text{A}$                                | 0.70 | 0.85 | 1.06 | V                          |
| $R_{DS(on)}$                   | Static Drain-Source On-Resistance        | $V_{GS} = 2.7\text{ V}, I_D = 0.2\text{ A}$<br>$T_J = 125^\circ\text{C}$ |      | 3.8  | 5    | $\Omega$                   |
|                                |                                          |                                                                          |      | 6.3  | 9    |                            |
|                                |                                          |                                                                          |      | 3.1  | 4    |                            |
| $I_{D(on)}$                    | On-State Drain Current                   | $V_{GS} = 2.7\text{ V}, V_{DS} = 5\text{ V}$                             | 0.2  |      |      | A                          |
| $g_{FS}$                       | Forward Transconductance                 | $V_{DS} = 5\text{ V}, I_D = 0.4\text{ A}$                                |      | 0.2  |      | S                          |

#### DYNAMIC CHARACTERISTICS

|           |                              |                                                                      |  |     |  |    |
|-----------|------------------------------|----------------------------------------------------------------------|--|-----|--|----|
| $C_{iss}$ | Input Capacitance            | $V_{DS} = 10\text{ V}, V_{GS} = 0\text{ V},$<br>$f = 1.0\text{ MHz}$ |  | 9.5 |  | pF |
| $C_{oss}$ | Output Capacitance           |                                                                      |  | 6   |  | pF |
| $C_{rss}$ | Reverse Transfer Capacitance |                                                                      |  | 1.3 |  | pF |

#### SWITCHING CHARACTERISTICS (Note)

|              |                       |                                                                                             |  |      |     |    |
|--------------|-----------------------|---------------------------------------------------------------------------------------------|--|------|-----|----|
| $t_{D(on)}$  | Turn - On Delay Time  | $V_{DD} = 6\text{ V}, I_D = 0.5\text{ A},$<br>$V_{GS} = 4.5\text{ V}, R_{GEN} = 50\ \Omega$ |  | 3.2  | 8   | ns |
| $t_r$        | Turn - On Rise Time   |                                                                                             |  | 6    | 15  | ns |
| $t_{D(off)}$ | Turn - Off Delay Time |                                                                                             |  | 3.5  | 8   | ns |
| $t_f$        | Turn - Off Fall Time  |                                                                                             |  | 3.5  | 8   | ns |
| $Q_g$        | Total Gate Charge     | $V_{DS} = 5\text{ V}, I_D = 0.2\text{ A},$<br>$V_{GS} = 4.5\text{ V}$                       |  | 0.49 | 0.7 | nC |
| $Q_{gs}$     | Gate-Source Charge    |                                                                                             |  | 0.22 |     | nC |
| $Q_{gd}$     | Gate-Drain Charge     |                                                                                             |  | 0.07 |     | nC |

#### DRAIN-SOURCE DIODE CHARACTERISTICS AND MAXIMUM RATINGS

|          |                                                       |                                                   |  |      |     |   |
|----------|-------------------------------------------------------|---------------------------------------------------|--|------|-----|---|
| $I_S$    | Maximum Continuous Drain-Source Diode Forward Current |                                                   |  | 0.29 |     | A |
| $V_{SD}$ | Drain-Source Diode Forward Voltage                    | $V_{GS} = 0\text{ V}, I_S = 0.29\text{ A}$ (Note) |  | 0.8  | 1.2 | V |

Note:  
Pulse Test: Pulse Width  $\leq 300\ \mu\text{s}$ , Duty Cycle  $\leq 2.0\%$ .

## Typical Electrical Characteristics

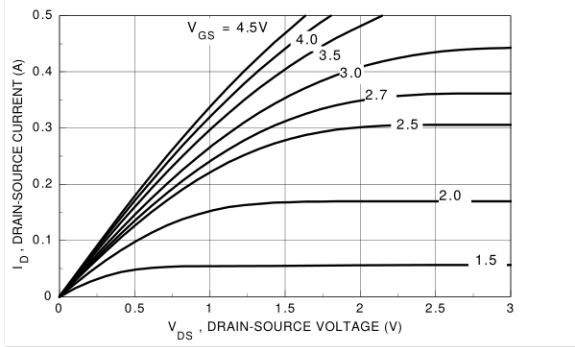

Figure 1. On-Region Characteristics.

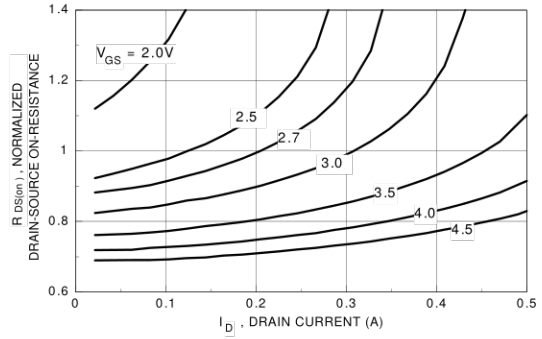

Figure 2. On-Resistance Variation with Drain Current and Gate Voltage.

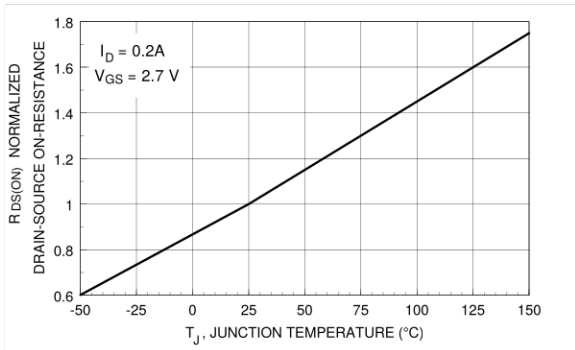

Figure 3. On-Resistance Variation with Temperature.

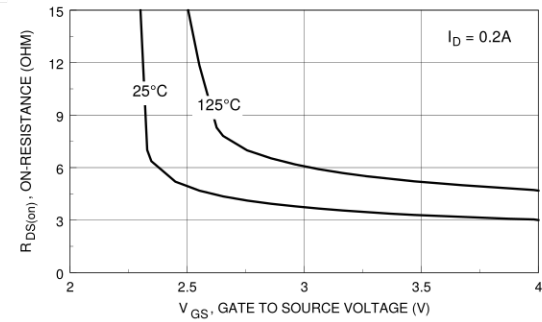

Figure 4. On Resistance Variation with Gate-To-Source Voltage.

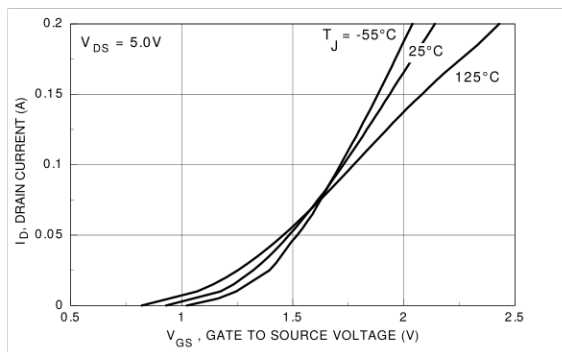

Figure 5. Transfer Characteristics.

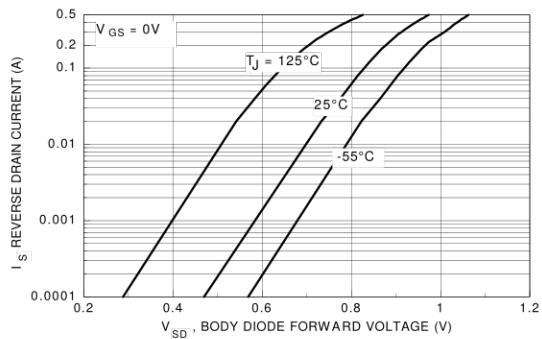

Figure 6. Body Diode Forward Voltage Variation with Source Current and Temperature.

## Typical Electrical And Thermal Characteristics

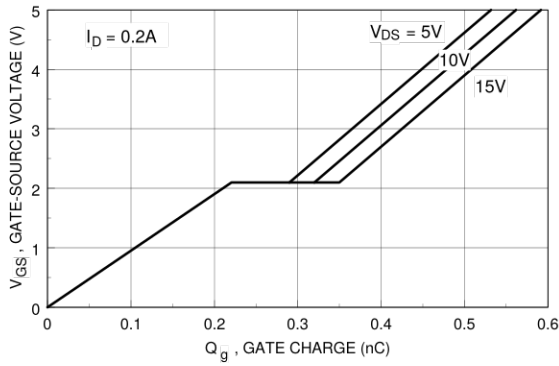

Figure 7. Gate Charge Characteristics.

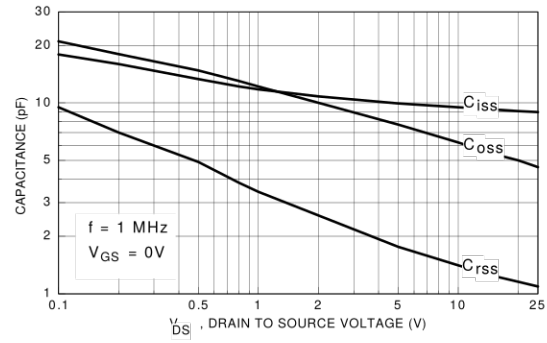

Figure 8. Capacitance Characteristics.

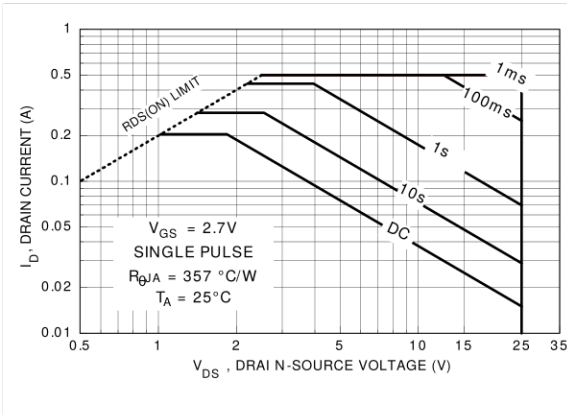

Figure 9. Maximum Safe Operating Area.

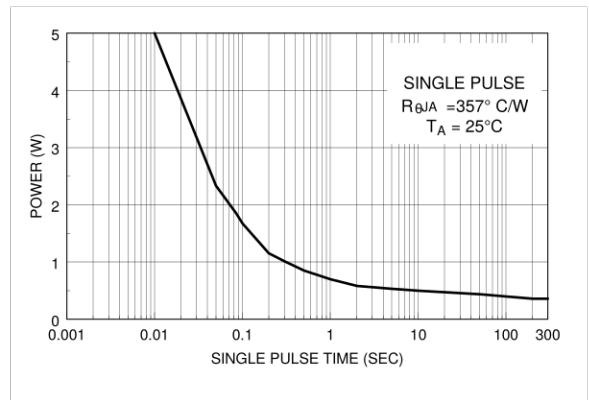

Figure 10. Single Pulse Maximum Power Dissipation.

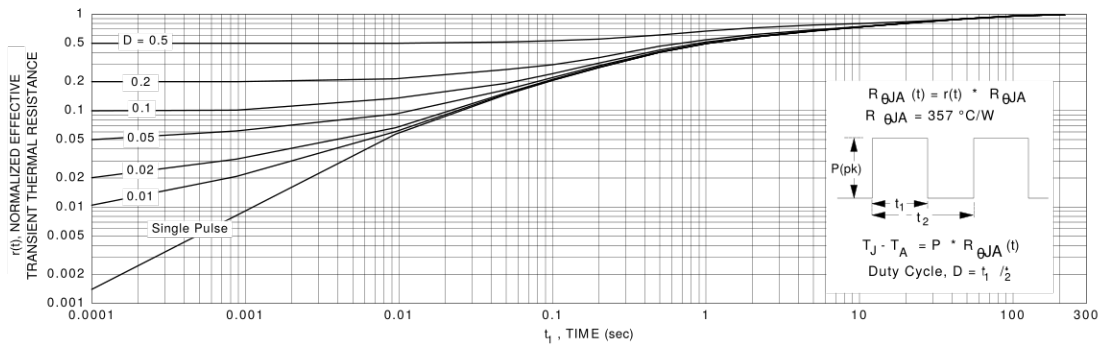







Figure 11. Transient Thermal Response Curve.



**TRADEMARKS**

The following includes registered and unregistered trademarks and service marks, owned by Fairchild Semiconductor and/or its global subsidiaries, and is not intended to be an exhaustive list of all such trademarks.

|                                                                                   |                                                                                     |                                                                                      |                      |
|-----------------------------------------------------------------------------------|-------------------------------------------------------------------------------------|--------------------------------------------------------------------------------------|----------------------|
| Auto-SPM™                                                                         | F-PFS™                                                                              | PowerTrench®                                                                         | The Power Franchise® |
| Build it Now™                                                                     | FRFET®                                                                              | PowerXS™                                                                             | the power®           |
| CorePLUS™                                                                         | Global Power ResourceSM                                                             | Programmable Active Droop™                                                           | franchise            |
| CorePOWER™                                                                        | Green FPS™                                                                          | QFET®                                                                                | TinyBoost™           |
| CROSSVOLT™                                                                        | Green FPS™ e-Series™                                                                | QS™                                                                                  | TinyBuck™            |
| CTL™                                                                              | Gmax™                                                                               | Quiet Series™                                                                        | TinyLogic®           |
| Current Transfer Logic™                                                           | GTO™                                                                                | RapidConfigure™                                                                      | TINYOPTO™            |
| EcoSPARK®                                                                         | IntelliMAX™                                                                         |  ™  | TinyPower™           |
| EfficientMax™                                                                     | ISOPLANAR™                                                                          | Saving our world, 1mW /W /kW at a time™                                              | TinyPwm™             |
| EZSWITCH™ *                                                                       | MegaBuck™                                                                           | SmartMax™                                                                            | TinyWire™            |
|  | MICROCOUPLER™                                                                       | SMART START™                                                                         | TriFault Detect™     |
|  | MicroFET™                                                                           | SPM®                                                                                 | TRUECURRENT™*        |
| Fairchild®                                                                        | MicroPak™                                                                           | STEALTH™                                                                             | µSerDes™             |
| Fairchild Semiconductor®                                                          | MillerDrive™                                                                        | SuperFET™                                                                            | UHC®                 |
| FACT Quiet Series™                                                                | MotionMax™                                                                          | SuperSOT™-3                                                                          | Ultra FRFET™         |
| FACT®                                                                             | Motion-SPM™                                                                         | SuperSOT™-6                                                                          | UniFET™              |
| FAST®                                                                             | OPTOLOGIC®                                                                          | SuperSOT™-8                                                                          | VCX™                 |
| FastvCore™                                                                        | OPTOPLANAR®                                                                         | SupreMOS™                                                                            | VisualMax™           |
| FETBench™                                                                         |  ™ | SyncFET™                                                                             | XS™                  |
| FlashWriter® *                                                                    | PDP SPM™                                                                            | Sync-Lock™                                                                           |                      |
| FPS™                                                                              | Power-SPM™                                                                          |  ®* |                      |

\*Trademarks of System General Corporation, used under license by Fairchild Semiconductor.

**DISCLAIMER**

FAIRCHILD SEMICONDUCTOR RESERVES THE RIGHT TO MAKE CHANGES WITHOUT FURTHER NOTICE TO ANY PRODUCTS HEREIN TO IMPROVE RELIABILITY, FUNCTION, OR DESIGN. FAIRCHILD DOES NOT ASSUME ANY LIABILITY ARISING OUT OF THE APPLICATION OR USE OF ANY PRODUCT OR CIRCUIT DESCRIBED HEREIN; NEITHER DOES IT CONVEY ANY LICENSE UNDER ITS PATENT RIGHTS, NOR THE RIGHTS OF OTHERS. THESE SPECIFICATIONS DO NOT EXPAND THE TERMS OF FAIRCHILD'S WORLDWIDE TERMS AND CONDITIONS, SPECIFICALLY THE WARRANTY THEREIN, WHICH COVERS THESE PRODUCTS.

**LIFE SUPPORT POLICY**

FAIRCHILD'S PRODUCTS ARE NOT AUTHORIZED FOR USE AS CRITICAL COMPONENTS IN LIFE SUPPORT DEVICES OR SYSTEMS WITHOUT THE EXPRESS WRITTEN APPROVAL OF FAIRCHILD SEMICONDUCTOR CORPORATION.

As used herein:

- Life support devices or systems are devices or systems which, (a) are intended for surgical implant into the body or (b) support or sustain life, and (c) whose failure to perform when properly used in accordance with instructions for use provided in the labeling, can be reasonably expected to result in a significant injury of the user.
- A critical component in any component of a life support, device, or system whose failure to perform can be reasonably expected to cause the failure of the life support device or system, or to affect its safety or effectiveness.

**ANTI-COUNTERFEITING POLICY**

Fairchild Semiconductor Corporation's Anti-Counterfeiting Policy. Fairchild's Anti-Counterfeiting Policy is also stated on our external website, [www.Fairchildsemi.com](http://www.Fairchildsemi.com), under Sales Support.

Counterfeiting of semiconductor parts is a growing problem in the industry. All manufactures of semiconductor products are experiencing counterfeiting of their parts. Customers who inadvertently purchase counterfeit parts experience many problems such as loss of brand reputation, substandard performance, failed application, and increased cost of production and manufacturing delays. Fairchild is taking strong measures to protect ourselves and our customers from the proliferation of counterfeit parts. Fairchild strongly encourages customers to purchase Fairchild parts either directly from Fairchild or from Authorized Fairchild Distributors who are listed by country on our web page cited above. Products customers buy either from Fairchild directly or from Authorized Fairchild Distributors are genuine parts, have full traceability, meet Fairchild's quality standards for handling and storage and provide access to Fairchild's full range of up-to-date technical and product information. Fairchild and our Authorized Distributors will stand behind all warranties and will appropriately address and warranty issues that may arise. Fairchild will not provide any warranty coverage or other assistance for parts bought from Unauthorized Sources. Fairchild is committed to combat this global problem and encourage our customers to do their part in stopping this practice by buying direct or from authorized distributors.

**PRODUCT STATUS DEFINITIONS**

**Definition of Terms**

| Datasheet Identification | Product Status        | Definition                                                                                                                                                                                          |
|--------------------------|-----------------------|-----------------------------------------------------------------------------------------------------------------------------------------------------------------------------------------------------|
| Advance Information      | Formative / In Design | Datasheet contains the design specifications for product development. Specifications may change in any manner without notice.                                                                       |
| Preliminary              | First Production      | Datasheet contains preliminary data; supplementary data will be published at a later date. Fairchild Semiconductor reserves the right to make changes at any time without notice to improve design. |
| No Identification Needed | Full Production       | Datasheet contains final specifications. Fairchild Semiconductor reserves the right to make changes at any time without notice to improve the design.                                               |
| Obsolete                 | Not In Production     | Datasheet contains specifications on a product that is discontinued by Fairchild Semiconductor. The datasheet is for reference information only.                                                    |