

POWER RELAY

1 POLE - 3A/5A Slim Type Relay

FTR-F3 Series

■ FEATURES

- High density mounting
Slim type with 7mm width and 142mm² mounting space
1C type; height 15mm and 164 mm² mounting space
right angle type; height 7mm, 330 mm² mounting space
- High insulation
Insulation distance:
minimum 6mm (7mm for 1C and right angle type)
between coil and contact (conforms to IEC 60065)
Dielectric strength: 4KV
Surge strength: 10KV
- Cadmium free contact for eco-program
- Safety standards
UL, CSA, VDE, SEMKO, CQC
- Plastic sealed relay, RTIII
- RoHS compliant
Please see page 7 for more information



■ PARTNUMBER INFORMATION

[Example] $\frac{\text{FTR-F3}}{\text{(a)}} \quad \frac{\text{A}}{\text{(b)}} \quad \frac{\text{A}}{\text{(c)}} \quad \frac{\text{012}}{\text{(d)}} \quad \frac{\text{V}}{\text{(e)}} \quad \text{- HA} \quad \frac{\text{}}{\text{(f)}}$

(a)	Relay type	FTR-F3 :FTR-F3-Series
(b)	Contact configuration	A : 1 form A, straight terminals C : 1 form C, straight terminals P : 1 form A, right angle terminals
(c)	Coil type (power)	A : 200mW, 3A and 5A types, FTR-F3 (A;P) A (...) E (-HA); (-KS) : 280mW, TV3 and TV5 types, FTR-F3 (A;P) A (...) (V;T) : 360mW, 1 form C type, FTR-F3CA (...) E
(d)	Coil rated voltage	012 : 5.....24 VDC Coil rating table at page 3
(e)	Contact material	V : AgSnO ₂ TV5 type, 1 form A type only (280mW coil) T : AgSnO ₂ TV3 type, 1 form A type only (280mW coil) E : AgNi 3A and 5A types only (not for TV3 and TV5 types)
(f)	Contact rating	Nil : 3A type and V and T types only HA : 5A type (for type FTR-F3AA only) (not for TV types) KS : Sealing confirmed (3A type FTR-F3AA (...) E only)

Actual marking does not carry the type name : "FTR"

E.g.: Ordering code: FTR-F3AA012V

Actual marking: F3AA012V

5A 250V~ 5A 30VDC and TV rating marked on relay

Ordering code: FTR-F3AA012E-HA

Actual marking: F3AA012E

5A 250V~ 5A 30VDC marked on relay

FTR-F3 SERIES

■ SPECIFICATION

Item	FTR-F3					
	3A type		5A type		TV3 / TV5 type	
Contact Data	Configuration	1 form A	1 form A	1 form C	1 form A	
	Construction	Single				
	Material	Silver nickel (AgNi)			Ag alloy (AgSnO ₂)	
	Resistance (initial)	Max. 100mΩ at 1A, 6VDC				
	Contact rating (resistive)	3A, 125VAC, 30VDC	5A, 250VAC, 30VDC	5A, 250VAC, 30VDC		
				TV3: (120VAC) 3A / 51A / 125VAC 3A / 50A / 250VAC		
				TV5: (120VAC) 5A / 78A / 125VAC 5A / 80A / 250VAC		
	Max. carrying current	5A				
	Max. switching voltage	277VAC, 30VDC	277VAC, 30VDC	277VAC, 150VDC	277VAC, 150VDC	
Max. switching power	750VA, 90W	1,250VA, 150W				
Min. switching load *	10 mA, 5VDC					
Life	Mechanical	Min. 5 x 10 ⁶ operations	Min. 5 x 10 ⁶ operations	Min. 5 x 10 ⁶ operations	Min. 5 x 10 ⁶ operations	
	Electrical (at rated load)	Min. 200 x 10 ³ operations	Min. 100 x 10 ³ operations		Min. 100 x 10 ³ operations (3A, 250VAC/30VDC) Min. 50 x 10 ³ operations (5A, 250VAC/30VDC)	
Coil Data	Rated power (20 °C)	200mW	200mW	360mW	280mW	
	Operate power	113mW	113mW	200mW	156mW	
	Operating temperature range	-40 °C to +70 °C (no frost)	-40 °C to +70 °C (no frost)	-40 °C to +85 °C (no frost)	-40 °C to +85 °C (no frost)	
Timing Data	Operate (at nominal voltage)	Max. 10ms (without bounce, no diode)				
	Release (at nominal voltage)	Max. 10ms (without bounce, no diode)				
Insulation	Resistance (initial)	Min. 1,000MΩ at 500VDC				
	Dielectric strength	Open contacts	750VAC (50/60Hz) 1min			
		Contacts to coil	4,000VAC (50/60Hz) 1min			
	Surge strength	Contacts to coil	10,000V / 1.2 x 50μs standard wave			
	Clearance	6mm	6mm	7mm	7mm	
	Creepage	6mm	6mm	7mm	7mm	
	EN61810-1, VDE0435	Voltage	250V			
		Pollution degree	2			
Material group		III				
Category		C / 250V				
Other	Vibration resistance	Misoperation	10 to 55Hz double amplitude 1.5mm			
		Endurance	10 to 55Hz double amplitude 1.5mm			
	Shock	Misoperation	Min. 100m/s ² (11±1ms)			
		Endurance	Min. 1,000m/s ² (6±1ms)			
	Weight	Approximately 4g	Approx. 4g	Approx. 6g	Approximately 6g	
	Sealing	Plastic sealed RTIII				

* Minimum switching loads mentioned above are reference values. Please perform the confirmation test with actual load before production since reference values may vary according to switching frequencies, environmental conditions and expected reliability levels.

FTR-F3 SERIES

■ COIL RATING

200mW type

Coil Code	Rated Coil Voltage (VDC)	Coil Resistance +/- 10% (Ohm)	Must Operate Voltage (VDC) *	Must Release-Voltage (VDC) *	Max. Coil Voltage (VDC)	Rated Power (mW)
005	5	125	3.75	0.5	12	200
006	6	180	4.5	0.6	14.4	
009	9	405	6.75	0.9	21.6	
012	12	720	9	1.2	28.8	
018	18	1,620	13.5	1.8	43.2	
024	24	2,880	18	2.4	57.6	

280mW type

Coil Code	Rated Coil Voltage (VDC)	Coil Resistance +/- 10% (Ohm)	Must Operate Voltage (VDC) *	Must Release-Voltage (VDC) *	Max. Coil Voltage (VDC)	Rated Power (mW)
005	5	90	3.75	0.5	10	280
006	6	130	4.5	0.6	12	
009	9	290	6.75	0.9	19	
012	12	515	9	1.2	26	
018	18	1,160	13.5	1.8	39	
024	24	2,060	18	2.4	52	

360mW type

Coil Code	Rated Coil Voltage (VDC)	Coil Resistance +/- 10% (Ohm)	Must Operate Voltage (VDC) *	Must Release-Voltage (VDC) *	Max. Coil Voltage (VDC)	Rated Power (mW)
005	5	69	3.75	0.5	9	360
006	6	100	4.5	0.6	11	
009	9	225	6.75	0.9	16	
012	12	400	9	1.2	21	
018	18	900	13.5	1.8	32	
024	24	1,600	18	2.4	42	

Note: All values in the tables are valid for 20°C and zero contact current.

* Specified operate values are valid for pulse wave voltage.

■ SAFETY STANDARDS

Type	Compliance	Contact rating
UL	UL 508	Flammability: UL 94-V0 (plastics)
	E63614	3A, 30 VDC/ 277 VAC (resistive) 1/10 HP, 250VAC /125VAC
CSA	C22.2 No. 14 LR 40304	1/8 HP, 277VAC Pilot duty: D300
VDE	0435 40015024	5A, 250 VAC, $\cos\phi = 1 = 100 \times 10^3$, 85°C, FTR-F3 AA -E 3A, 250 VAC, $\cos\phi = 1 = 200 \times 10^3$, 85°C, FTR-F3 AA -E 5A, 30 VDC, 0 msec = 100×10^3 , 85°C, FTR-F3 AA -E 3A, 30 VDC, 0 msec = 200×10^3 , 85°C, FTR-F3 AA -E 5A, 250 VAC, $\cos\phi = 1 = 50 \times 10^3$, 70°C, FTR-F3 CA (CO) 5A, 30 VDC, 0msec = 100×10^3 , 70°C, FTR-F3 CA (CO) 3A, 30 VDC, 0msec = 200×10^3 , 70°C, FTR-F3 CA (CO) 5A, 250 VAC, $\cos\phi = 1 = 50 \times 10^3$, 85°C, FTR-F3 (A;P) A - (V;T) 3A, 250 VAC, $\cos\phi = 1 = 100 \times 10^3$, 85°C, FTR-F3 (A;P) A - (V;T) 3/51A, 250 VAC = 10×10^3 , 85°C, FTR-F3 (A;P) A - T 5/80A, 250 VAC = 10×10^3 , 85°C, FTR-F3 (A;P) A - V
SEMKO	EN 61058-1: 1992 +A1:1993 EN 61095:1993+A11	5A, 250 VAC 40T70

CHARACTERISTIC DATA

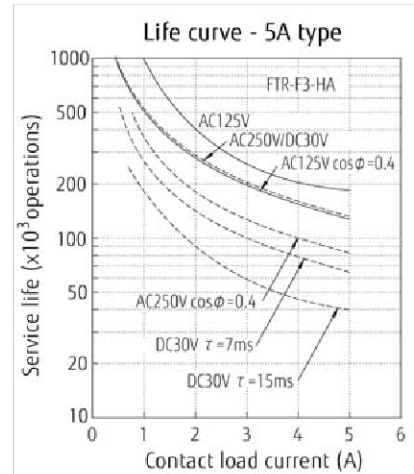
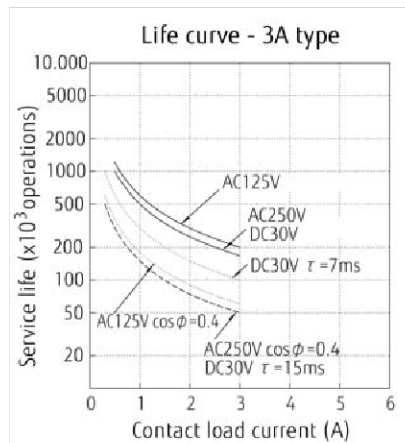
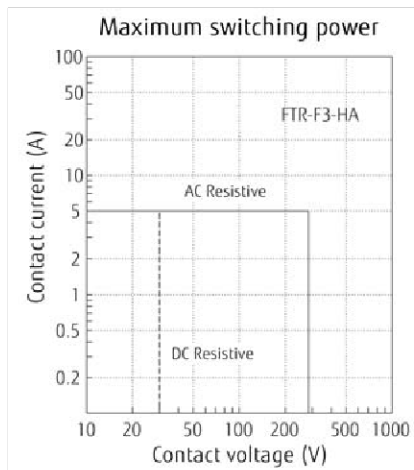
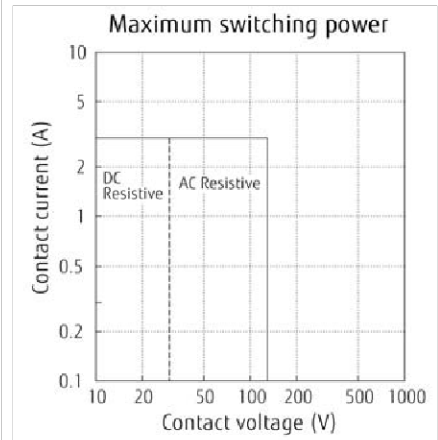
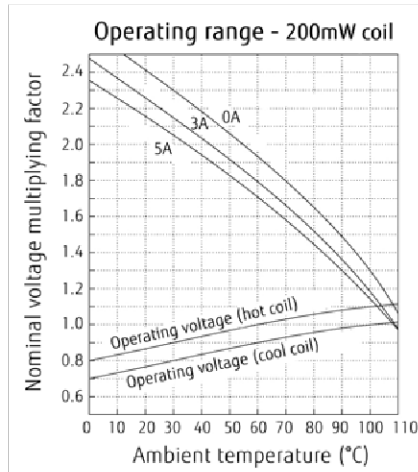
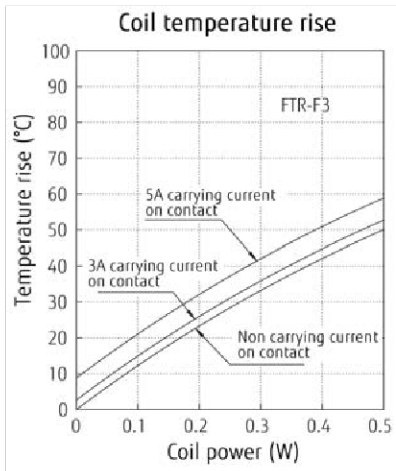

REFERENCE DATA

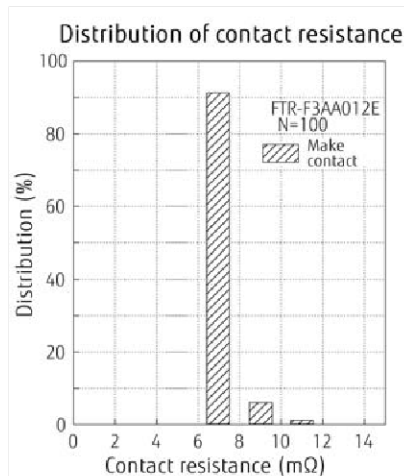
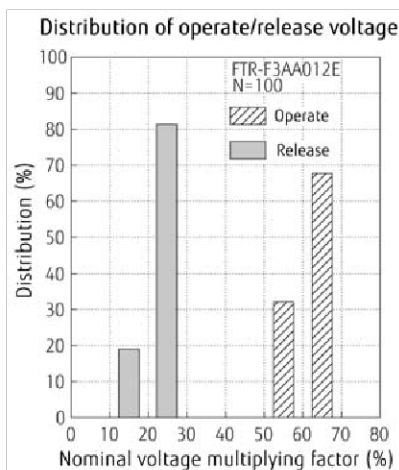

■ DIMENSIONS Unit: mm

Standard type

● Dimensions

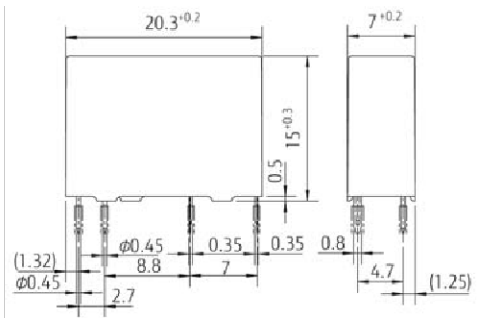

● Schematics (BOTTOM VIEW)

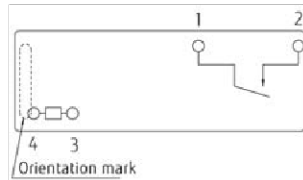

● PC board mounting hole layout (BOTTOM VIEW)

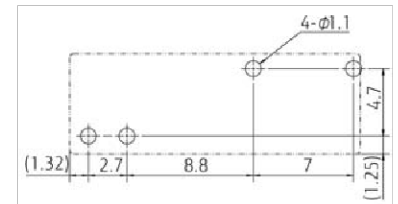

Change-over-contact type

● Dimensions

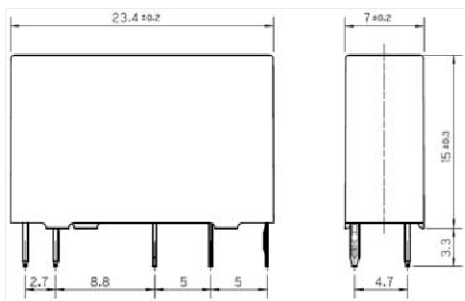

● Schematics (BOTTOM VIEW)

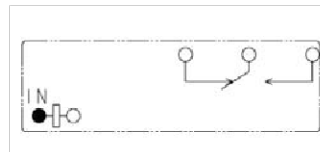

● PC board mounting hole layout (BOTTOM VIEW)

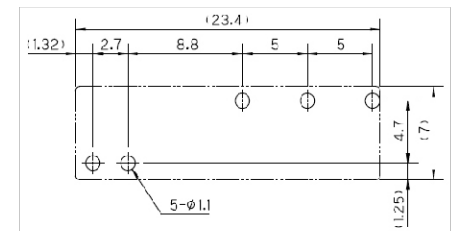

Right angle type

● Dimensions

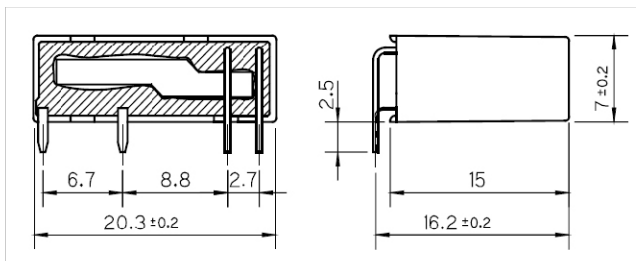

● Schematics (BOTTOM VIEW)

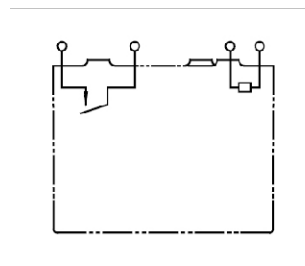

● PC board mounting hole layout (BOTTOM VIEW)

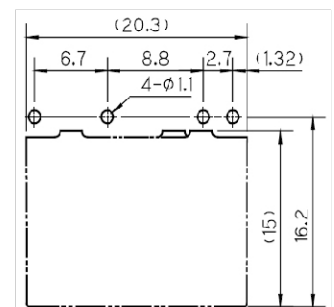

RoHS Compliance and Lead Free Information

1. General Information

- All signal and power relays produced by Fujitsu Components are compliant with RoHS directive 2002/95EC including amendments.
- Cadmium as used in electrical contacts is exempted from the RoHS directives on October 21st, 2005. (Amendment to Directive 2002/95/EC)
- All of our signal and power relays are lead-free. Please refer to Lead-Free Status Info for older date codes at: <http://www.fujitsu.com/us/downloads/MICRO/fcai/relays/lead-free-letter.pdf>
- Lead free solder plating on relay terminals is Sn-3.0Ag-0.5Cu, unless otherwise specified. This material has been verified to be compatible with PbSn assembly process.

2. Recommended Lead Free Solder Profile

- **Recommended solder Sn-3.0Ag-0.5Cu.**

Flow Solder condition:

Pre-heating: maximum 120°C
Soldering: dip within 5 sec. at
260°C solder bath

Solder by Soldering Iron:

Soldering Iron
Temperature: maximum 360°C
Duration: maximum 3 sec.

We highly recommend that you confirm your actual solder conditions

3. Moisture Sensitivity

- Moisture Sensitivity Level standard is not applicable to electromechanical relays, unless otherwise indicated.

4. Tin Whiskers

- Dipped SnAgCu solder is known as presenting a low risk to tin whisker development. No considerable length whisker was found by our in house test.

Fujitsu Components International Headquarter Offices

Japan

Fujitsu Component Limited
Gotanda-Chuo Building
3-5, Higashigotanda 2-chome, Shinagawa-ku
Tokyo 141, Japan
Tel: (81-3) 5449-7010
Fax: (81-3) 5449-2626
Email: promothq@ft.ed.fujitsu.com
Web: www.fcl.fujitsu.com

North and South America

Fujitsu Components America, Inc.
250 E. Caribbean Drive
Sunnyvale, CA 94089 U.S.A.
Tel: (1-408) 745-4900
Fax: (1-408) 745-4970
Email: components@us.fujitsu.com
Web: <http://us.fujitsu.com/components>

Europe

Fujitsu Components Europe B.V.
Diamantlaan 25
2132 WV Hoofddorp
Netherlands
Tel: (31-23) 5560910
Fax: (31-23) 5560950
Email: info@fceu.fujitsu.com
Web: emea.fujitsu.com/components/

Asia Pacific

Fujitsu Components Asia Ltd.
102E Pasir Panjang Road
#01-01 Citilink Warehouse Complex
Singapore 118529
Tel: (65) 6375-8560
Fax: (65) 6273-3021
Email: fcal@fcal.fujitsu.com
Web: <http://www.fujitsu.com/sg/services/micro/components/>

©2011 Fujitsu Components Europe B.V. All rights reserved. All trademarks or registered trademarks are the property of their respective owners.

The contents, data and information in this datasheet are provided by Fujitsu Component Ltd. as a service only to its user and only for general information purposes.

The use of the contents, data and information provided in this datasheet is at the users' own risk.

Fujitsu has assembled this datasheet with care and will endeavor to keep the contents, data and information correct, accurate, comprehensive, complete and up to date.

Fujitsu Components Europe B.V. and affiliated companies do however not accept any responsibility or liability on their behalf, nor on behalf of its employees, for any loss or damage, direct, indirect or consequential, with respect to this datasheet, its contents, data, and information and related graphics and the correctness, reliability, accuracy, comprehensiveness, usefulness, availability and completeness thereof.

Nor do Fujitsu Components Europe B.V. and affiliated companies accept on their behalf, nor on behalf of its employees, any responsibility or liability for any representation or warrant of any kind, express or implied, including warranties of any kind for merchantability or fitness for particular use, with respect to these datasheets, its contents, data, information and related graphics and the correctness, reliability, accuracy, comprehensiveness, usefulness, availability and completeness thereof. Rev. March 30, 2011