



Parameter	Rating	Units
Blocking Voltage	250	V_P
Load Current	200	mA_{rms} / mA_{DC}
On-Resistance (max)	15	Ω

Features

- Integrated active current-limit protection
- Thermal shutdown
- Linear AC or DC operation
- Low power consumption
- Clean, bounce-free switching
- High surge capability
- Low power drive requirements
- Surface mount version available
- Tape & reel packaging available

Applications

- Fault protected switch
- Instrumentation
- Elevator controls
- Industrial controls
- Security
- Peripherals
 - Automatic tuning/balancing
 - Transducer driver
- Pre-driver for large electro-mechanical relays
- Telecom switching
- Medical equipment

Pin Configuration

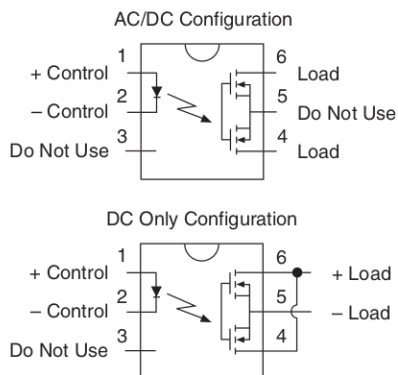

Description

The CPC1510 is a single-pole, normally open (1-Form-A) Solid State Relay with an integrated current limit feature that can replace electromechanical relays while enhancing the robustness of wireline-interface applications.

The relay is constructed using a GaAlAs LED for actuation control and an integrated monolithic die for the switch output. The die, fabricated in a high-voltage dielectrically isolated technology, comprises a photodiode array, switch control with active current limiting circuitry, and MOSFET switches. The active current limit circuitry in the CPC1510 also provides a thermal shutdown feature offering excellent power cross immunity for improved survivability in harsh environments.

These enhancements greatly improve the robustness of end systems using this device compared to systems using relays without the integrated current limit. In addition, the active current limit circuitry enables the CPC1510 to pass FCC 68.302 and other regulatory voltage surge requirements when adequate overvoltage protection is provided. The CPC1510 relay may be used in both unidirectional DC applications as well as bi-directional AC applications.

Approvals

- UL Approved Component: File # E76270
- CSA Certified Component: Certificate # 1172007
- EN/IEC 60950-1 Certified Component: Pending

Ordering Information

Part #	Description
CPC1510G	6-Pin 0.250" Wide, Through Hole (50/Tube)
CPC1510GS	6-Pin 0.250" Wide, Surface Mount (50/Tube)
CPC1510GSTR	6-Pin 0.250" Wide, Surface Mount (1000/Reel)

Switching Characteristics of Normally Open Devices

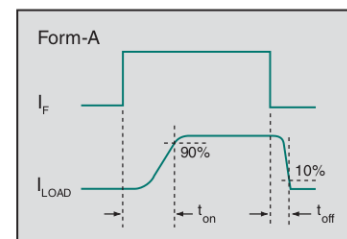

Absolute Maximum Ratings @ 25°C

Parameter	Ratings	Units
Blocking Voltage	250	V _P
Reverse Input Voltage	5	V
Input LED Current		
Continuous	50	mA
Peak (10ms)	1	A
Input Control Current	10	mA
Input Power Dissipation ¹	150	mW
Total Power Dissipation ²	800	mW
Isolation Voltage, Input to Output	3750	V _{rms}
Operational Temperature	-40 to +85	°C
Storage Temperature	-40 to +125	°C

¹ Derate Linearly 1.33 mW/°C

² Derate Linearly 1.67 mW/°C

Absolute Maximum Ratings are stress ratings. Stresses in excess of these ratings can cause permanent damage to the device. Functional operation of the device at conditions beyond those indicated in the operational sections of this data sheet is not implied.

Typical values are characteristic of the device at +25°C, and are the result of engineering evaluations. They are provided for information purposes only, and are not part of the manufacturing testing requirements.

Recommended Operating Conditions

Parameter	Symbol	Configuration	Min	Nominal	Max	Units
Load Current, Continuous	I _L	AC/DC	-	-	200	mA _{rms} / mA _{DC}
		DC-Only	-	-	350	mA _{DC}
Input Control Current	I _F	-	3	5	10	mA
Operating Temperature Range	T _A	-	-40	-	+85	°C

Electrical Characteristics @ 25°C

Parameter	Conditions	Symbol	Min	Typ	Max	Units
Output Characteristics						
Current Limit						
AC/DC Configuration	I _F =5mA, V _L =±5V, t=5ms	I _{LMT}	300	366	450	mA _P
DC Configuration			600	730	920	
On-Resistance						
AC/DC Configuration	I _F =5mA, I _L =100mA	R _{ON}	6	13	15	Ω
DC Configuration			1.5	3.3	3.75	
Off-State Leakage Current	V _L =200V	I _{LEAK}	-	1.3e ⁻⁵	1	μA
Switching Speeds						
Turn-On	I _F =5mA, I _L =10mA, V _L =10V	t _{on}	-	0.845	2	ms
Turn-Off			t _{off}	-		
Output Capacitance						
	I _F =0mA, V _L =1V, f=1MHz	C _O	-	205	-	pF
	I _F =0mA, V _L =50V, f=1MHz			65		
Input Characteristics						
Input Control Current to Activate	I _L =100mA	I _F	-	-	2	mA
Input Control Current to Deactivate	I _L =100mA	I _F	0.2	-	-	mA
LED Forward Voltage	I _F =5mA	V _F	1.15	1.37	1.5	V
Common Characteristics						
Input to Output Capacitance	-	C _{I/O}	-	3	-	pF

PERFORMANCE DATA*

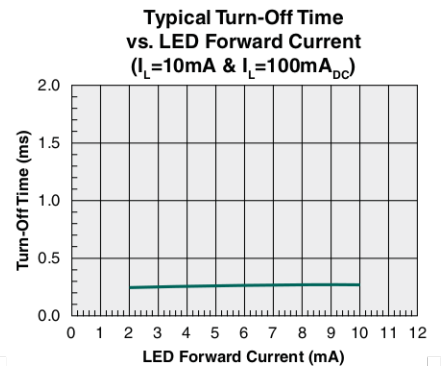
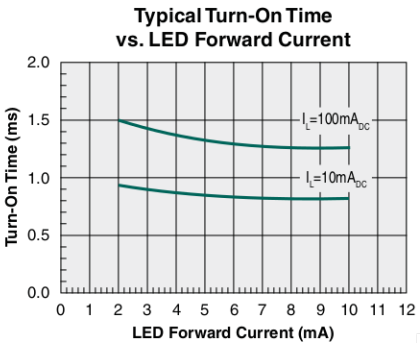
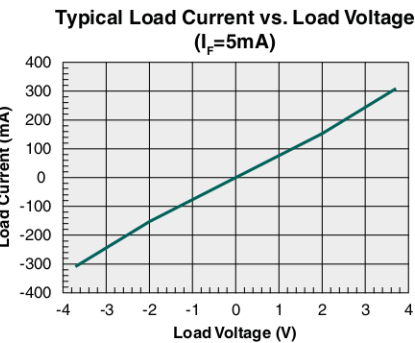
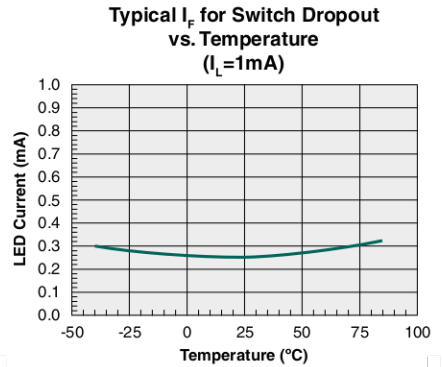
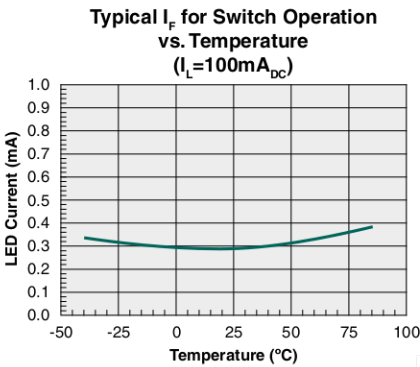
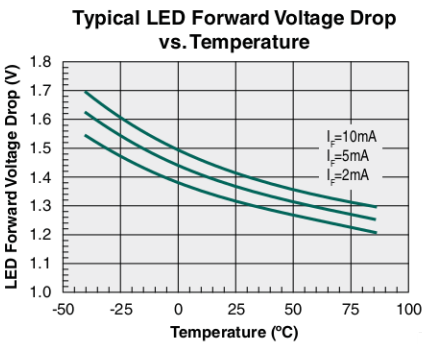
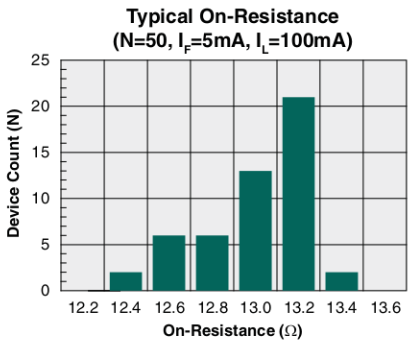
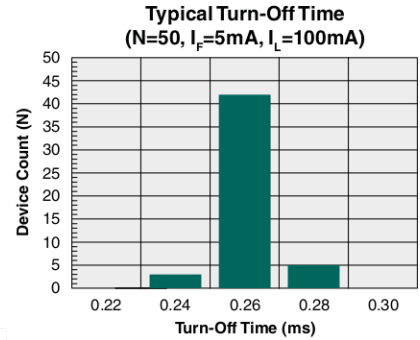
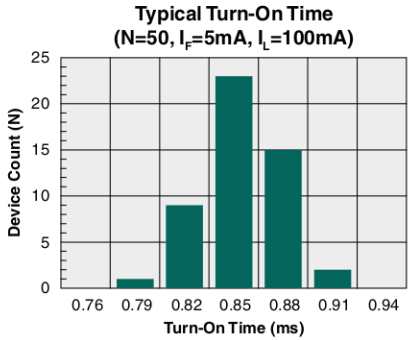
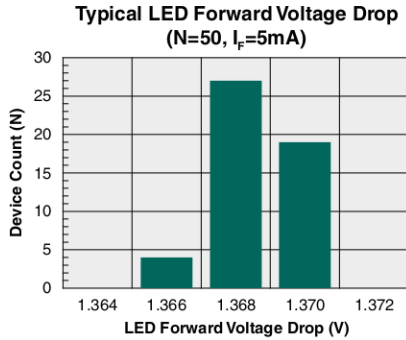

*Unless otherwise noted, data presented in these graphs is typical of device operation at 25°C.
For guaranteed parameters not indicated in the written specifications, please contact our application department.

PERFORMANCE DATA*

**On-Resistance vs. Temperature
AC/DC Configuration
($I_F=2mA$, $I_L=100mA_{DC}$)**

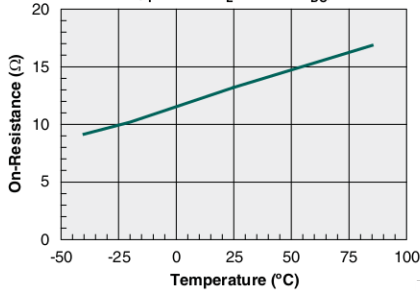

**Typical Turn-On Time vs. Temperature
($I_L=100mA_{DC}$)**

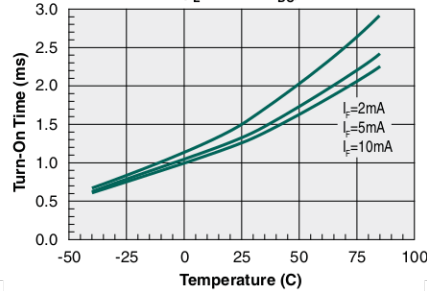

**Typical Turn-Off Time vs. Temperature
($I_L=100mA_{DC}$)**

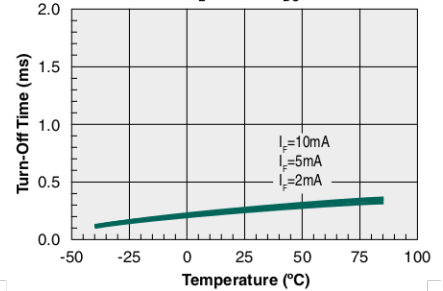

**On-Resistance vs. Temperature
DC-Only Configuration
($I_F=2-10mA$, $I_L=100mA_{DC}$)**

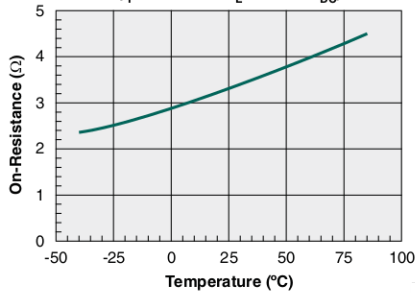

**Typical Turn-On Time vs. Temperature
($I_L=10mA_{DC}$)**

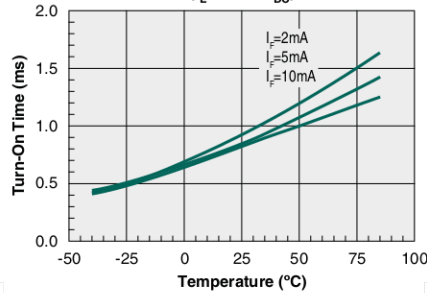

**Typical Turn-Off Time vs. Temperature
($I_F=2-10mA$, $I_L=10mA_{DC}$)**

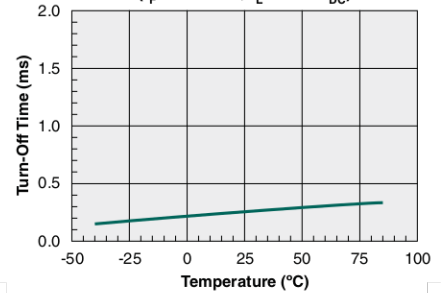

**Maximum Load Current
vs. Temperature**

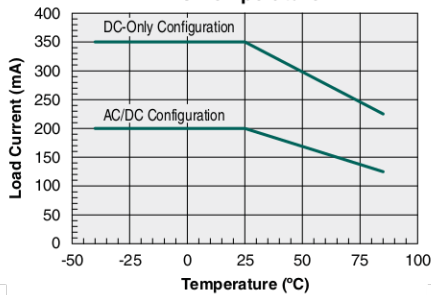

**Typical Current Limit vs. Temperature
($I_F=5mA$)**

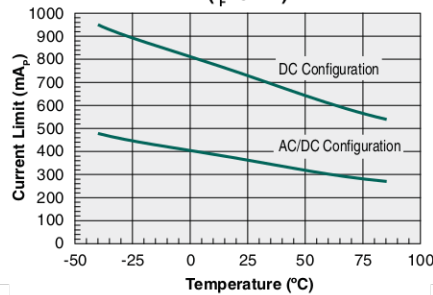

**Typical Leakage Current vs. Temperature
(Measured with 250V across pins 6 & 4)**

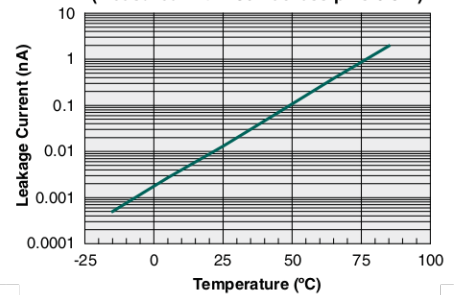

*Unless otherwise noted, data presented in these graphs is typical of device operation at 25°C.
For guaranteed parameters not indicated in the written specifications, please contact our application department.

Manufacturing Information

Moisture Sensitivity



All plastic encapsulated semiconductor packages are susceptible to moisture ingress. IXYS Integrated Circuits classifies its plastic encapsulated devices for moisture sensitivity according to the latest version of the joint industry standard, **IPC/JEDEC J-STD-020**, in force at the time of product evaluation. We test all of our products to the maximum conditions set forth in the standard, and guarantee proper operation of our devices when handled according to the limitations and information in that standard as well as to any limitations set forth in the information or standards referenced below.

Failure to adhere to the warnings or limitations as established by the listed specifications could result in reduced product performance, reduction of operable life, and/or reduction of overall reliability.

This product carries a **Moisture Sensitivity Level (MSL)** classification as shown below, and should be handled according to the requirements of the latest version of the joint industry standard **IPC/JEDEC J-STD-033**.

Device	Moisture Sensitivity Level (MSL) Classification
CPC1510GS	MSL 1

ESD Sensitivity



This product is ESD Sensitive, and should be handled according to the industry standard **JESD-625**.

Soldering Profile

Provided in the table below is the **IPC/JEDEC J-STD-020** Classification Temperature (T_C) and the maximum dwell time the body temperature of these surface mount devices may be ($T_C - 5$)°C or greater. The Classification Temperature sets the Maximum Body Temperature allowed for these devices during reflow soldering processes.

Device	Classification Temperature (T_C)	Dwell Time (t_p)	Max Reflow Cycles
CPC1510GS	250°C	30 seconds	3

The maximum wave soldering conditions of the through-hole devices is provided in the following table. Dwell time is the time it takes for the pins to pass through both waves.

Device	Maximum Wave Temperature	Body Temperature	Dwell Time	Wave Cycles
CPC1510G	260°C	250°C	10 seconds	1

Board Wash

IXYS Integrated Circuits recommends the use of no-clean flux formulations. Board washing to reduce or remove flux residue following the solder reflow process is acceptable provided proper precautions are taken to prevent damage to the device. These precautions include but are not limited to: using a low pressure wash and providing a follow up bake cycle sufficient to remove any moisture trapped within the device due to the washing process. Due to the variability of the wash parameters used to clean the board, determination of the bake temperature and duration necessary to remove the moisture trapped within the package is the responsibility of the user (assembler). Cleaning or drying methods that employ ultrasonic energy may damage the device and should not be used. Additionally, the device must not be exposed to halide flux or solvents that are Chlorine, Bromine, Fluorine, or Iodine-based.



Mechanical Dimensions

CPC1510G

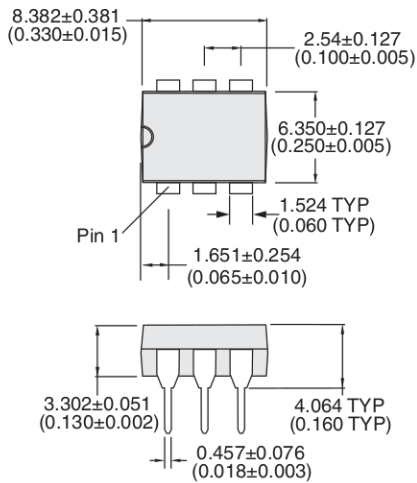

PCB Hole Pattern

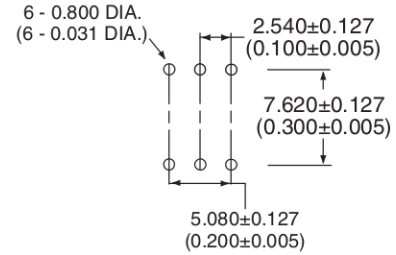

Dimensions
mm
(inches)

CPC1510GS

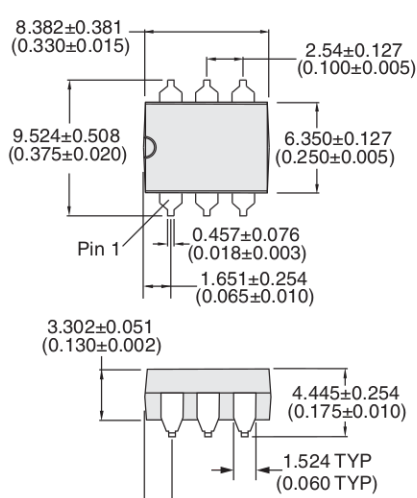

PCB Land Pattern

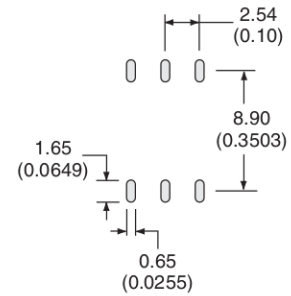

Dimensions
mm
(inches)

CPC1510GSTR Tape & Reel

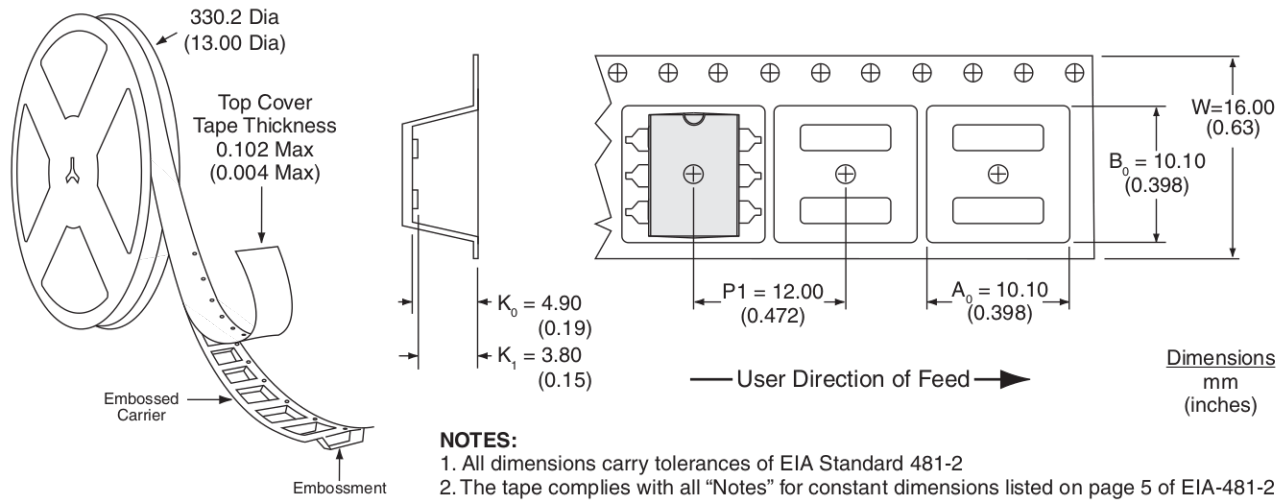

For additional information please visit our website at: www.ixysic.com

Disclaimer Notice - Littelfuse products are not designed for, and shall not be used for, any purpose (including, without limitation, automotive, military, aerospace, medical, life-saving, life-sustaining or nuclear facility applications, Components intended for surgical implant into the body, or any other application in which the failure or lack of desired operation of the product may result in personal injury, death, or property damage) other than those expressly set forth in applicable Littelfuse product documentation. Warranties granted by Littelfuse shall be deemed void for products used for any purpose not expressly set forth in applicable Littelfuse documentation. Littelfuse shall not be liable for any claims or damages arising out of products used in applications not expressly intended by Littelfuse as set forth in applicable Littelfuse documentation. The sale and use of Littelfuse products is subject to Littelfuse Terms and Conditions of Sale, unless otherwise agreed by Littelfuse. Information furnished is believed to be accurate and reliable. However, users should independently evaluate the suitability of and test each product selected for their own applications. Littelfuse products are not designed for, and may not be used in, all applications. Read complete Disclaimer Notice at www.littelfuse.com/disclaimer-electronics.

Specification: DS-CPC1510-R04
©Copyright 2019, Littelfuse, Inc.
OptoMOS® is a registered trademark of IXYS Integrated Circuits Division
All rights reserved. Printed in USA.
10/7/2019

The information below supercedes any previously presented material.

For additional information please visit our website at: <https://www.littelfuse.com>



Disclaimer Notice - Information furnished is believed to be accurate and reliable. However, users should independently evaluate the suitability of and test each product selected for their own applications. Littelfuse products are not designed for, and may not be used in, all applications. Read complete Disclaimer Notice at www.littelfuse.com/disclaimer-electronics.