

6367254 MOTOROLA SC (XSTRS/R F)

96D 81676 D

**MAXIMUM RATINGS**

Rating	Symbol	BC 256	BC 251	BC 252	Unit
Collector-Emitter Voltage	V <sub>CEO</sub>	65	45	25	V <sub>dc</sub>
Collector-Base Voltage	V <sub>CBO</sub>	80	50	30	V <sub>dc</sub>
Emitter-Base Voltage	V <sub>EBO</sub>	5.0			V <sub>dc</sub>
Collector Current - Continuous	I <sub>C</sub>	100			mAdc
Total Device Dissipation @ T <sub>A</sub> = 25°C Derate above 25°C	P <sub>D</sub>	350	2.8		mW mW/°C
Total Device Dissipation @ T <sub>C</sub> = 25°C Derate above 25°C	P <sub>D</sub>	1.0	8.0		Watt mW/°C
Operating and Storage Junction Temperature Range	T <sub>J</sub> , T <sub>stg</sub>	-55 to +150			°C

**THERMAL CHARACTERISTICS**

Characteristic	Symbol	Max	Unit
Thermal Resistance, Junction to Case	R <sub>θJC</sub>	125	°C/W
Thermal Resistance, Junction to Ambient	R <sub>θJA</sub>	357	°C/W

**BC251,A,B,C  
BC252,A,B,C  
BC256,A,B**

CASE 29-04, STYLE 17  
TO-92 (TO-226AA)

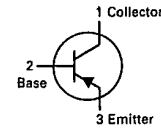

**AMPLIFIER TRANSISTORS**

PNP SILICON

Refer to BC556 for graphs.

**ELECTRICAL CHARACTERISTICS (T<sub>A</sub> = 25°C unless otherwise noted)**

Characteristic	Type	Symbol	Min.	Typ.	Max.	Unit
<b>OFF CHARACTERISTICS</b>						
Collector-Emitter Breakdown Voltage (I <sub>C</sub> = 2.0 mA, I <sub>B</sub> = 0)	BC256 BC251 BC252	V(BR)CEO	65 45 25			V
Emitter-Base Breakdown Voltage (I <sub>E</sub> = 100 μA, I <sub>C</sub> = 0)	BC256 BC251 BC252	V(BR)EBO	5 5 5			V
Collector-Emitter Leakage Current (V <sub>CE</sub> = 40 V) (V <sub>CE</sub> = 20 V)	BC256 BC251 BC252	I <sub>CES</sub>		2 2 2	100 100 100	nA
(V <sub>CE</sub> = 20 V, T <sub>A</sub> = 125°C)	BC256 BC251 BC252				4 4 4	μA

**ON CHARACTERISTICS**

DC Current Gain (I <sub>C</sub> = 10 μA, V <sub>CE</sub> = 5 V)	BC251A/2A/6A BC251B/2B/6B BC252C	h <sub>FE</sub>		90 150 270		
(I <sub>C</sub> = 2 mA, V <sub>CE</sub> = 5 V)	BC256 BC251 BC252		125 120 120		500 800 800	
(I <sub>C</sub> = 100 mA, V <sub>CE</sub> = 5 V)	BC251A/2A/6A BC251B/2B/6B BC251C/BC252C		120 180 380	170 290 500	220 460 800	
Collector-Emitter Saturation Voltage (I <sub>C</sub> = 10 mA, I <sub>B</sub> = 0.5 mA) (I <sub>C</sub> = 100 mA, I <sub>B</sub> = 5 mA)		V <sub>CE(sat)</sub>		0.075 0.25	0.3 0.65	V
Base-Emitter Saturation Voltage (I <sub>C</sub> = 10 mA, I <sub>B</sub> = 0.5 mA) (I <sub>C</sub> = 100 mA, I <sub>B</sub> = 5 mA)		V <sub>BE(sat)</sub>		0.70 1.00		V
Base-Emitter on Voltage (I <sub>C</sub> = 2 mA, V <sub>CE</sub> = 5 V)		V <sub>BE(on)</sub>	0.55	0.62	0.70	V

MOTOROLA SMALL-SIGNAL SEMICONDUCTORS

6367254 MOTOROLA SC (XSTRS/R F)

96D 81677 D

BC251,A,B,C, BC252,A,B,C, BC256,A,B

**ELECTRICAL CHARACTERISTICS** (continued) ( $T_A = 25^\circ\text{C}$  unless otherwise noted)

Characteristic	Type	Symbol	Min.	Typ.	Max.	Unit
<b>DYNAMIC CHARACTERISTICS</b>						
Current-Gain Bandwidth Product ( $I_C = 10\text{ mA}$ , $V_{CE} = 5\text{ V}$ , $f = 50\text{ MHz}$ )	BC256	$f_T$		280		MHz
	BC251			320		
	BC252			360		
Output Capacitance ( $V_{CB} = 10\text{ V}$ , $I_C = 0$ , $f = 1\text{ MHz}$ )		$C_{ob}$		3	6.0	pF
Noise Figure ( $I_C = 0.2\text{ mA}$ , $V_{CE} = 5\text{ V}$ , $R_S = 2\text{ Kohms}$ , $f = 1\text{ KHz}$ , $\Delta f = 200\text{ Hz}$ )	BC256	NF		2	10	dB
	BC251			2	10	
	BC252			2	10	

2

6367254 MOTOROLA SC (XSTRS/R F)

96D 81722 D

**BCX58,-7,-8,-9,-10**  
**BCX59,-7,-8,-9,-10**

CASE 29-04, STYLE 17  
TO-92 (TO-226AA)

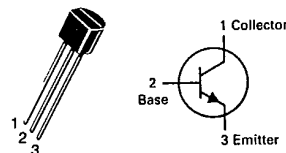

**AMPLIFIER TRANSISTORS**

NPN SILICON

**MAXIMUM RATINGS**

Rating	Symbol	BCX 58	BCX 59	Unit
Collector-Emitter Voltage	V <sub>CEO</sub>	32	45	V <sub>dc</sub>
Collector-Base Voltage	V <sub>CBO</sub>	32	45	V <sub>dc</sub>
Emitter-Base Voltage	V <sub>EBO</sub>	7.0		V <sub>dc</sub>
Collector Current - Continuous	I <sub>C</sub>	100		mAdc
Total Device Dissipation @ T <sub>A</sub> = 25°C Derate above 25°C	P <sub>D</sub>	625	5.0	mW mW/°C
Total Device Dissipation @ T <sub>C</sub> = 25°C Derate above 25°C	P <sub>D</sub>	1.5	12	Watt mW/°C
Operating and Storage Junction Temperature Range	T <sub>J</sub> , T <sub>stg</sub>	-55 to +150		°C

**THERMAL CHARACTERISTICS**

Characteristic	Symbol	Max	Unit
Thermal Resistance, Junction to Case	R <sub>θJC</sub>	83.3	°C/W
Thermal Resistance, Junction to Ambient	R <sub>θJA</sub>	200	°C/W

**ELECTRICAL CHARACTERISTICS** (T<sub>A</sub> = 25°C unless otherwise noted.)

Characteristic	Symbol	Min	Typ	Max	Unit	
<b>OFF CHARACTERISTICS</b>						
Collector-Emitter Breakdown Voltage (I <sub>C</sub> = 10 mAdc, I <sub>B</sub> = 0)	BCX58 BCX59	V <sub>(BR)CEO</sub>	32 45	—	V <sub>dc</sub>	
Emitter-Base Breakdown Voltage (I <sub>E</sub> = 1.0 μAdc, I <sub>C</sub> = 0)	All	V <sub>(BR)EBO</sub>	7.0	8.7	V <sub>dc</sub>	
Collector Cutoff Current (V <sub>CE</sub> = 32 V) (V <sub>CE</sub> = 45 V) (V <sub>CE</sub> = 32 V, T <sub>A</sub> = 100°C, V <sub>BE</sub> = 0.2 V) (V <sub>CE</sub> = 45 V, T <sub>A</sub> = 100°C, V <sub>BE</sub> = 0.2 V) (V <sub>CE</sub> = 32 V, T <sub>A</sub> = 125°C) (V <sub>CE</sub> = 45 V, T <sub>A</sub> = 125°C)	BCX58 BCX59 BCX58 BCX59 BCX58 BCX59	I <sub>CES</sub>	—	—	10 10 20 20 2.5 2.5	nAdc μAdc
Emitter-Cutoff Current (V <sub>EBO</sub> = 4.0 V, I <sub>C</sub> = 0)		I <sub>EBO</sub>	—	—	20	nAdc
<b>ON CHARACTERISTICS</b>						
DC Current Gain (I <sub>C</sub> = 10 μAdc, V <sub>CE</sub> = 5.0 Vdc)	BCX58-7, BCX59-7 BCX58-8, BCX59-8 BCX58-9, BCX59-9 BCX58-10, BCX59-10	h <sub>FE</sub>	20 40 75 100	80 145 220 300	—	
(I <sub>C</sub> = 2.0 mAdc, V <sub>CE</sub> = 5.0 Vdc)	BCX58-7, BCX59-7 BCX58-8, BCX59-8 BCX58-9, BCX59-9 BCX58-10, BCX59-10		120 180 250 380	170 250 350 500	220 310 480 630	
(I <sub>C</sub> = 10 mAdc, V <sub>CE</sub> = 1.0 Vdc)	BCX58-7, BCX59-7 BCX58-8, BCX59-8 BCX58-9, BCX59-9 BCX58-10, BCX59-10		80 120 160 240	180 260 380 550	— 400 630 1000	
(I <sub>C</sub> = 100 mAdc, V <sub>CE</sub> = 2.0 Vdc)	BCX58-7, BCX59-7 BCX58-8, BCX59-8 BCX58-9, BCX59-9 BCX58-10, BCX59-10		40 45 60 60	— — — —	— — — —	
Collector-Emitter Saturation Voltage (I <sub>C</sub> = 100 mAdc, I <sub>B</sub> = 5.0 mAdc)		V <sub>CE(sat)</sub>	—	—	0.5	V <sub>dc</sub>
Base-Emitter Saturation Voltage (I <sub>C</sub> = 100 mA, I <sub>B</sub> = 2.5 mAdc)		V <sub>BE(sat)</sub>	—	—	1.0	V <sub>dc</sub>
Base-Emitter On Voltage (I <sub>C</sub> = 2.0 mAdc, V <sub>CE</sub> = 5.0 Vdc)		V <sub>BE(on)</sub>	0.55	—	0.7	V <sub>dc</sub>

MOTOROLA SMALL-SIGNAL SEMICONDUCTORS

6367254 MOTOROLA SC (XSTRS/R F)

96D 81723 D

BCX58,-7,-8,-9,-10, BCX59,-7,-8,-9,-10

**ELECTRICAL CHARACTERISTICS** (continued) ( $T_A = 25^\circ\text{C}$  unless otherwise noted.)

Characteristic	Symbol	Min	Typ	Max	Unit
<b>SMALL-SIGNAL CHARACTERISTICS</b>					
Current-Gain Bandwidth Product ( $I_C = 10\text{ mAdc}$ , $V_{CE} = 5.0\text{ V}$ , $f = 100\text{ MHz}$ )	$f_T$	125	250	—	MHz
Output Capacitance ( $V_{CE} = 10\text{ Vdc}$ , $I_C = 0$ , $f = 1.0\text{ MHz}$ )	$C_{ob}$	—	1.8	4.5	pF
Input Capacitance ( $V_{BE} = 0.5\text{ V}$ , $I_C = 0$ , $f = 1.0\text{ MHz}$ )	$C_{ib}$	—	5.2	15	pF
Small-Signal Current Gain ( $I_C = 2.0\text{ mAdc}$ , $V_{CE} = 5.0\text{ Vdc}$ , $f = 1.0\text{ kHz}$ )	$h_{fe}$	125 175 250 350	— — — —	250 350 500 700	—
Noise Figure ( $I_C = 0.2\text{ mAdc}$ , $V_{CE} = 5.0\text{ Vdc}$ , $R_S = 2.0\text{ kohms}$ , $f = 1.0\text{ kHz}$ )	NF	—	1.0	6.0	dB
( $I_C = 10\text{ mA}$ , $I_{B1} = 1.0\text{ mA}$ , $I_{B2} = 1.0\text{ mA}$ ) ( $V_{BB} = 3.6\text{ V}$ , $R_1 = R_2 = 5.0\text{ k}\Omega$ ) ( $R_L = 999\text{ ohms}$ )  *See test circuit	$T_d$	—	16	—	ns
	$T_r$	—	29	—	
	$T_{on}$	—	45	150	
	$T_s$	—	475	—	
	$T_f$	—	40	—	
	$T_{off}$	—	515	800	
( $I_C = 100\text{ mA}$ , $I_{B1} = 10\text{ mA}$ , $I_{B2} = 10\text{ mA}$ ) ( $V_{BB} = 5.0\text{ V}$ , $R_1 = 500\ \Omega$ , $R_2 = 700\ \Omega$ ) ( $R_L = 98\text{ ohms}$ )  *See test circuit	$t_d$	—	5.0	—	ns
	$t_r$	—	40	—	
	$t_{on}$	—	45	150	
	$t_s$	—	135	—	
	$t_f$	—	80	—	
	$t_{off}$	—	215	800	

2

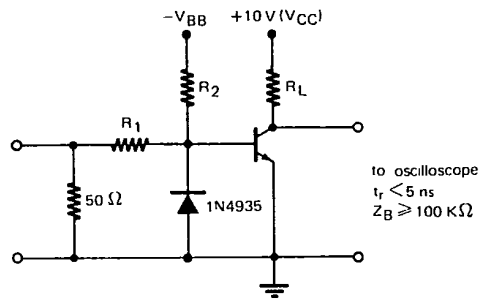
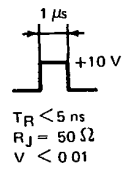

6367254 MOTOROLA SC (XSTRS/R F)

96D 81724 D

BCX58,-7,-8,-9,-10, BCX59,-7,-8,-9,-10

FIGURE 1 - NORMALIZED DC CURRENT GAIN

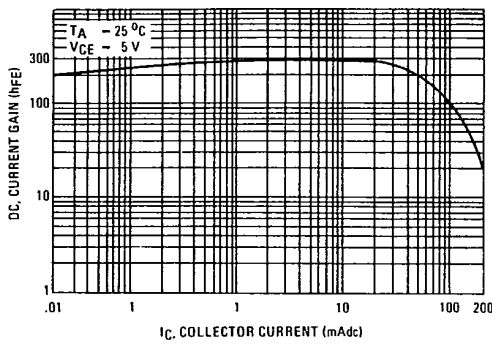

FIGURE 2 - "SATURATION" AND "ON" VOLTAGES

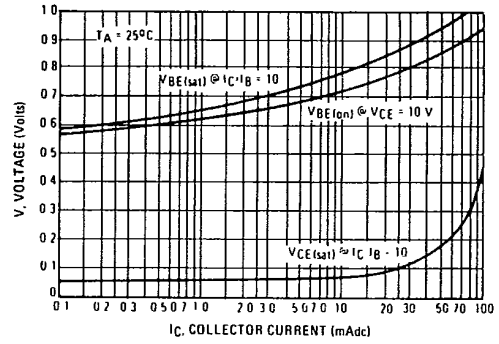

FIGURE 3 - COLLECTOR SATURATION REGION

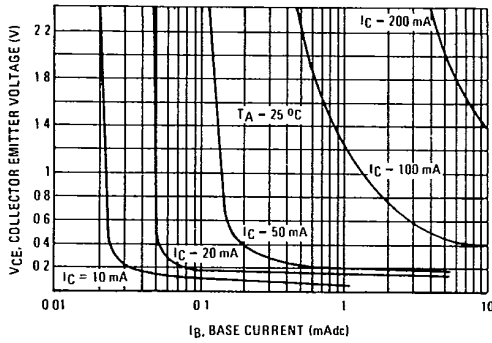

FIGURE 4 - BASE-EMITTER TEMPERATURE COEFFICIENT

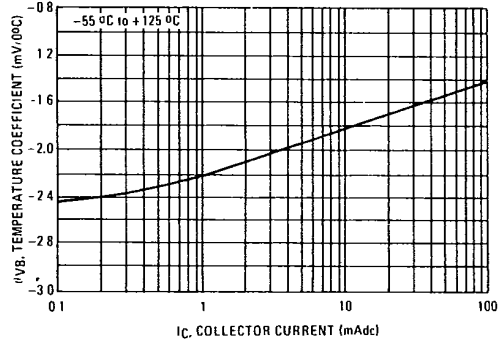

FIGURE 5 - CAPACITANCES

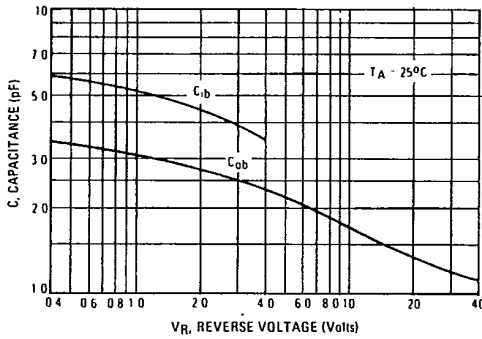

FIGURE 6 - CURRENT-GAIN-BANDWIDTH PRODUCT

