

Bipolar Transistor

**(-)100 V, (-)2 A, Low $V_{CE(sat)}$,
(PNP) NPN Single PCP**

2SA1417, 2SC3647

Features

- Adoption of FBET, MBIT Processes
- High Breakdown Voltage and Large Current Capacity
- Ultrasmall Size Making it Easy to Provide High-density Small-sized Hybrid ICs
- These Devices are Pb-Free and Halide Free

SPECIFICATIONS (): 2SA1417

ABSOLUTE MAXIMUM RATINGS ($T_A = 25^\circ\text{C}$)

Symbol	Parameter	Conditions	Ratings	Unit
V_{CBO}	Collector-to-Base Voltage		(-)120	V
V_{CEO}	Collector-to-Emitter Voltage		(-)100	V
V_{EBO}	Emitter-to-Base Voltage		(-)6	V
I_C	Collector Current		(-)2	A
I_{CP}	Collector Current (Pulse)		(-)3	A
P_C	Collector Dissipation	When mounted on ceramic substrate (250 mm ² x 0.8 mm)	500	mW
			1.5	W
T_j	Junction Temperature		150	°C
T_{stg}	Storage Temperature		- 55 to +150	°C

Stresses exceeding those listed in the Maximum Ratings table may damage the device. If any of these limits are exceeded, device functionality should not be assumed, damage may occur and reliability may be affected.

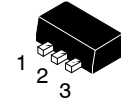

SOT-89-3
CASE 419AU

ELECTRICAL CONNECTION

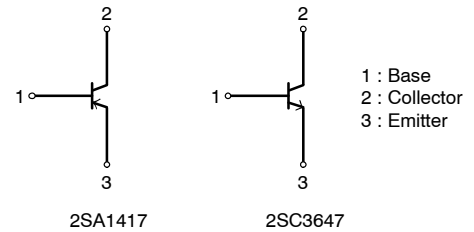

MARKING DIAGRAM

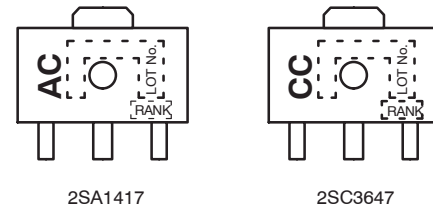

ORDERING INFORMATION

Device	Package	Shipping†
2SA1417S-TD-E	PCP (Pb-Free)	1000 / Tape & Reel
2SA1417T-TD-E	PCP (Pb-Free)	1000 / Tape & Reel
2SC3647S-TD-E	PCP (Pb-Free)	1000 / Tape & Reel
2SC3647T-TD-E	PCP (Pb-Free)	1000 / Tape & Reel

†For information on tape and reel specifications, including part orientation and tape sizes, please refer to our Tape and Reel Packaging Specifications Brochure, [BRD8011/D](#).

2SA1417, 2SC3647

ELECTRICAL CHARACTERISTICS ($T_A = 25^\circ\text{C}$)

Symbol	Parameter	Conditions	Ratings			Unit
			Min	Typ	Max	
I_{CBO}	Collector Cutoff Current	$V_{CB} = (-)100\text{ V}, I_E = 0\text{ A}$	-	-	(-)100	nA
I_{EBO}	Emitter Cutoff Current	$V_{EB} = (-)4\text{ V}, I_C = 0\text{ A}$	-	-	(-)100	nA
h_{FE}	DC Current Gain	$V_{CE} = (-)5\text{ V}, I_C = (-)100\text{ mA}$	100*	-	400*	-
f_T	Gain-Bandwidth Product	$V_{CE} = (-)10\text{ V}, I_C = (-)100\text{ mA}$	-	120	-	MHz
C_{ob}	Output Capacitance	$V_{CB} = (-)10\text{ V}, f = 1\text{ MHz}$	-	(25)16	-	pF
$V_{CE(sat)}$	Collector-to-Emitter Saturation Voltage	$I_C = (-)1\text{ A}, I_B = (-)100\text{ mA}$	-	(-0.22) 0.13	(-0.6) 0.4	V
$V_{BE(sat)}$	Base-to-Emitter Saturation Voltage	$I_C = (-)1\text{ A}, I_B = (-)100\text{ mA}$	-	(-)0.85	(-)1.2	V
$V_{(BR)CBO}$	Collector-to-Base Breakdown Voltage	$I_C = (-)10\text{ }\mu\text{A}, I_E = 0\text{ A}$	(-)120	-	-	V
$V_{(BR)CEO}$	Collector-to-Emitter Breakdown Voltage	$I_C = (-)1\text{ mA}, R_{BE} = \infty$	(-)100	-	-	V
$V_{(BR)EBO}$	Emitter-to-Base Breakdown Voltage	$I_E = (-)10\text{ }\mu\text{A}, I_C = 0\text{ A}$	(-)6	-	-	V
t_{on}	Turn-On Time	See specified Test Circuit.	-	(80)80	-	ns
t_{stg}	Storage Time		-	(750)1000	-	ns
t_f	Fall Time		-	(40)50	-	ns

Product parametric performance is indicated in the Electrical Characteristics for the listed test conditions, unless otherwise noted. Product performance may not be indicated by the Electrical Characteristics if operated under different conditions.

*The 2SA1417/2SC3647 are Classified by 100 mA h_{FE} as Follows:

Rank	R	S	T
h_{FE}	100 to 200	140 to 280	200 to 400

SWITCHING TIME TEST CIRCUIT

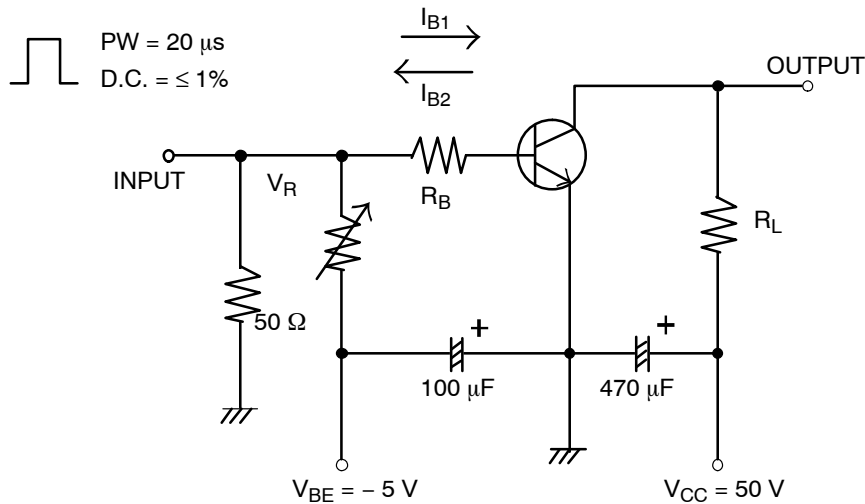

$I_C = 10\text{ mA}, I_{B1} = -10\text{ mA}, I_{B2} = 0.7\text{ mA}$
For PNP, the polarity is reversed.

Figure 1. Switching Time Test Circuit

TYPICAL CHARACTERISTICS

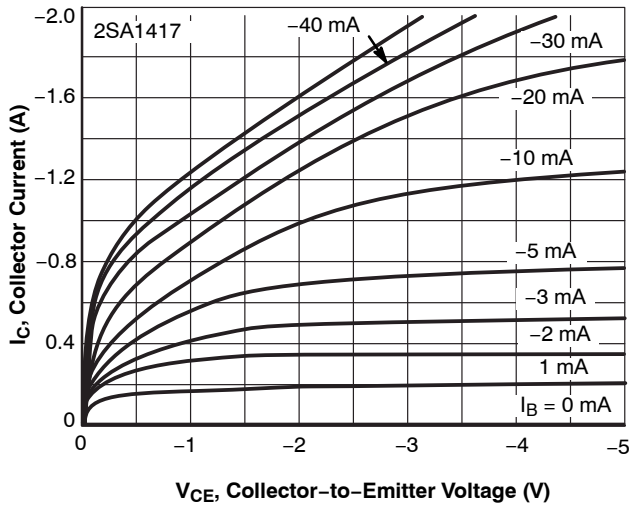

Figure 2. $I_C - V_{CE}$

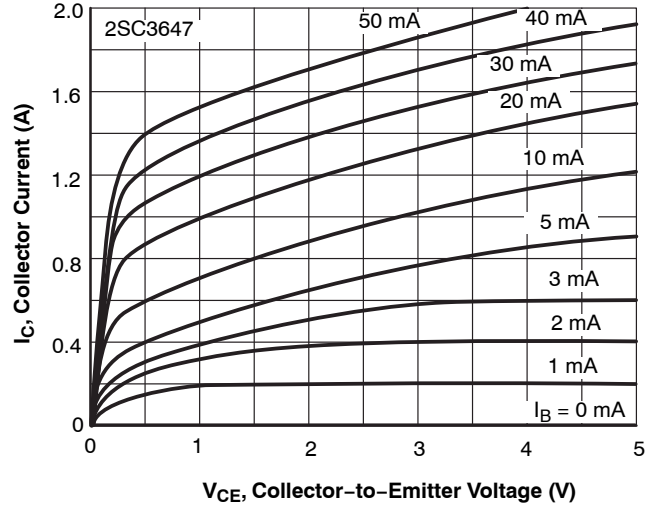

Figure 3. $I_C - V_{CE}$

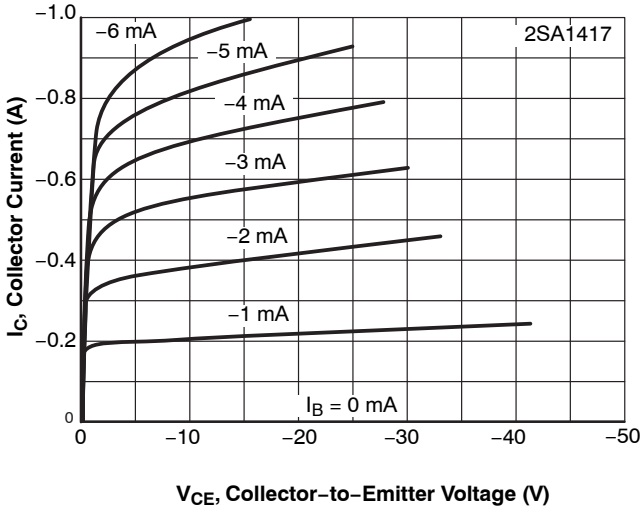

Figure 4. $I_C - V_{CE}$

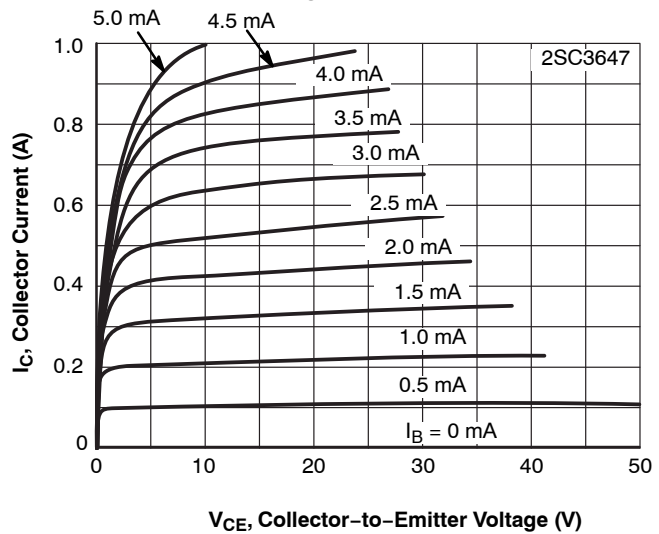

Figure 5. $I_C - V_{CE}$

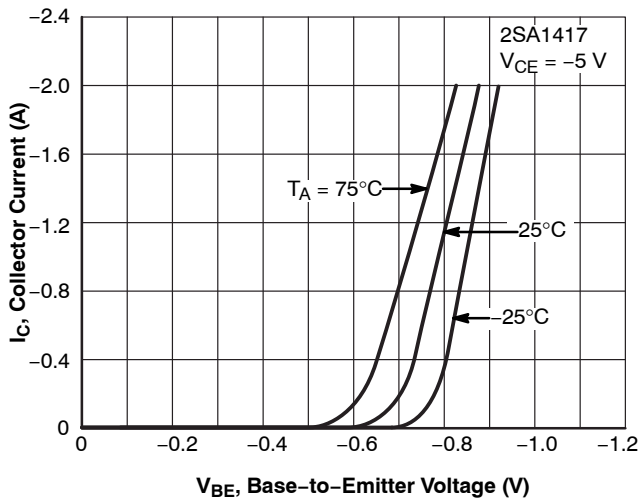

Figure 6. $I_C - V_{BE}$

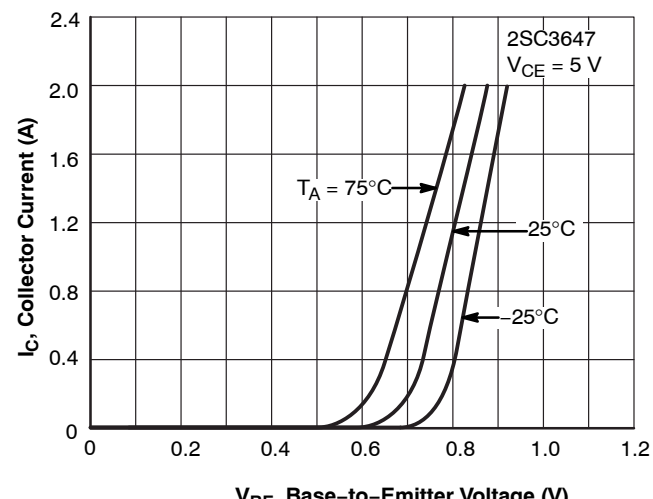

Figure 7. $I_C - V_{BE}$

2SA1417, 2SC3647

TYPICAL CHARACTERISTICS (continued)

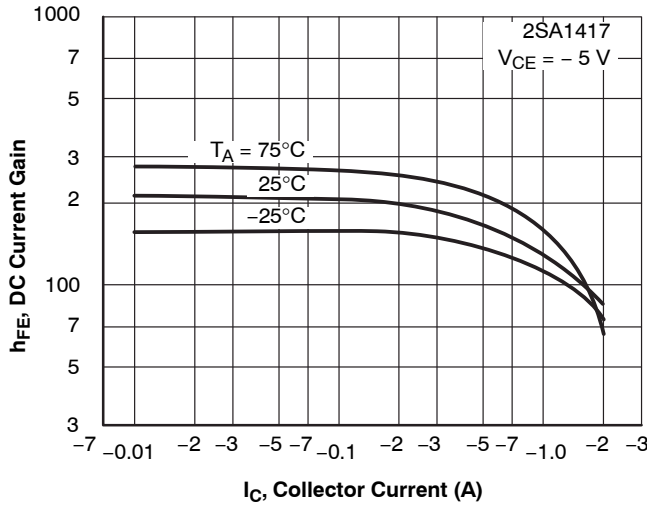

Figure 8. $h_{FE} - I_C$

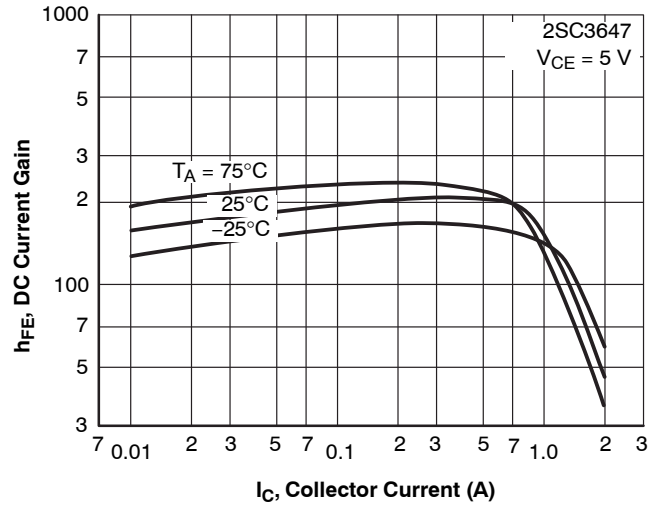

Figure 9. $h_{FE} - I_C$

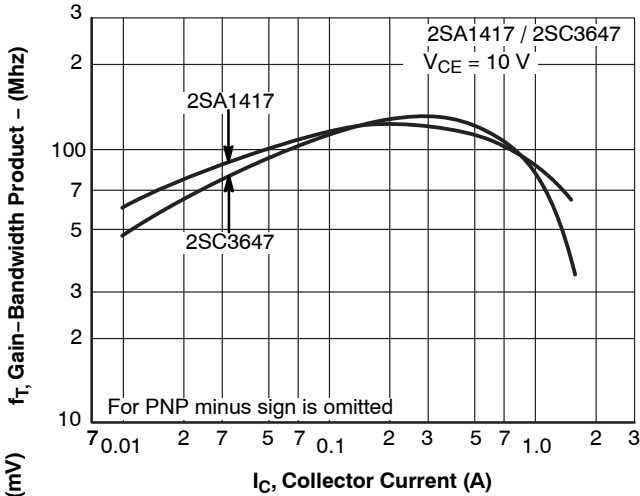

Figure 10. $f_T - I_C$

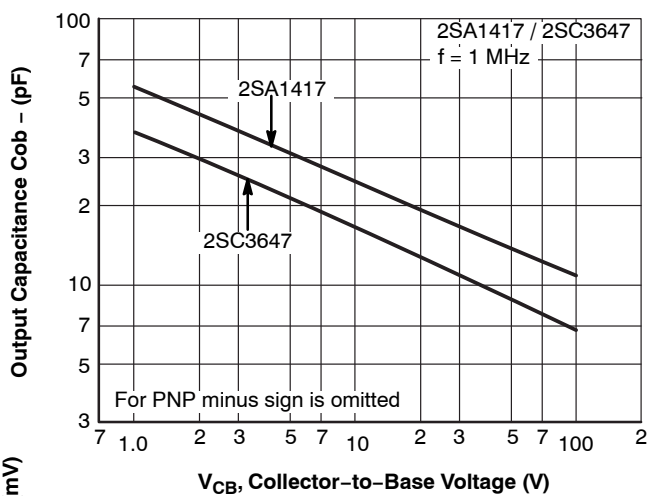

Figure 11. $C_{ob} - V_{CB}$

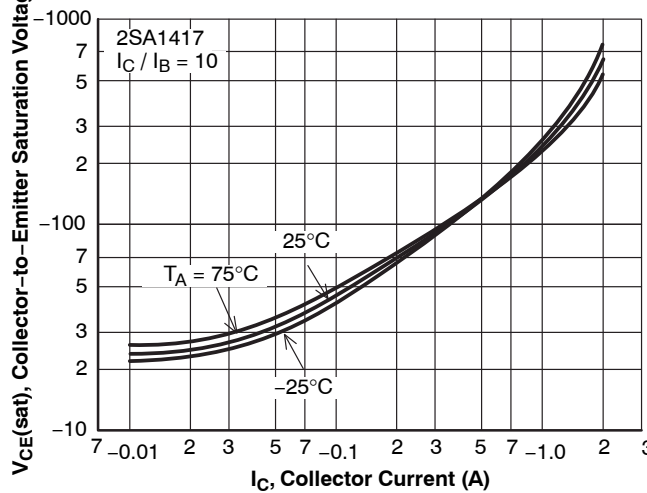

Figure 12. $V_{CE(sat)} - I_C$

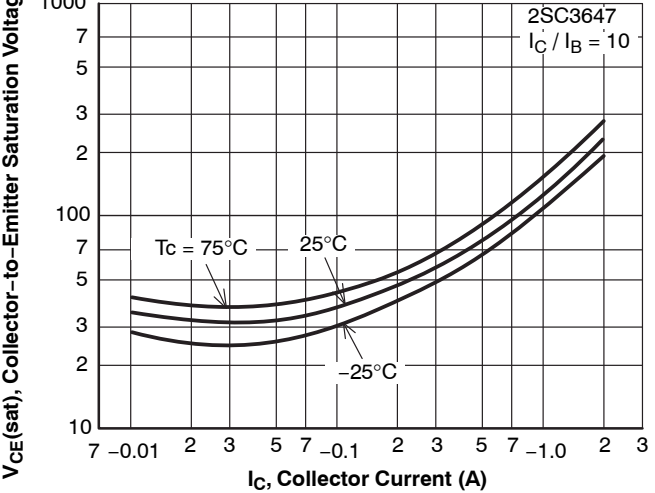

Figure 13. $V_{CE(sat)} - I_C$

2SA1417, 2SC3647

TYPICAL CHARACTERISTICS (continued)

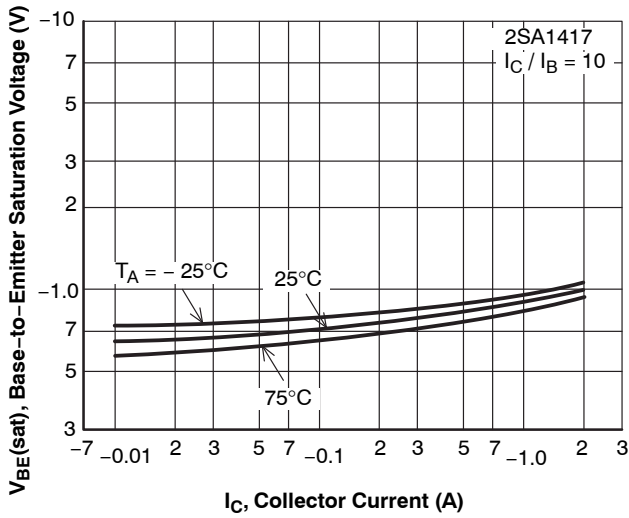

Figure 14. $V_{BE}(\text{sat}) - I_C$

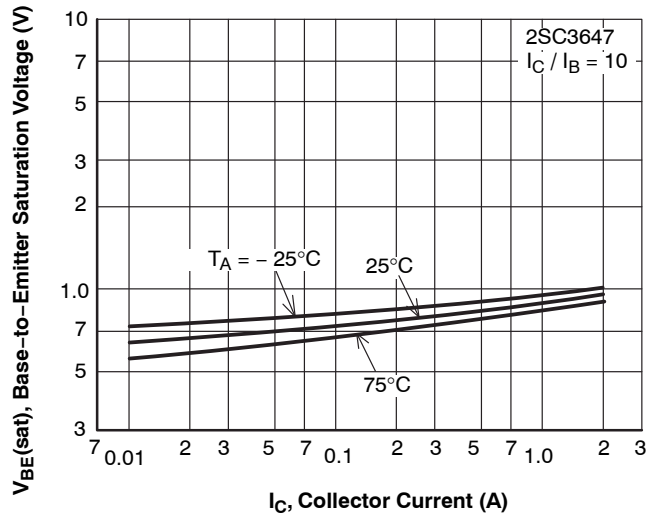

Figure 15. $V_{BE}(\text{sat}) - I_C$

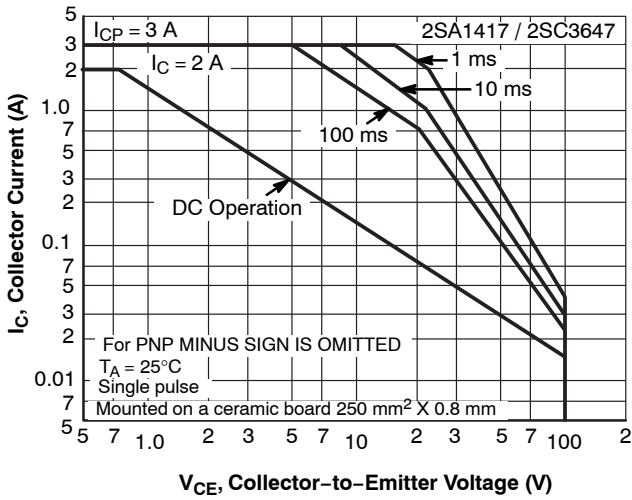

Figure 16. A S O

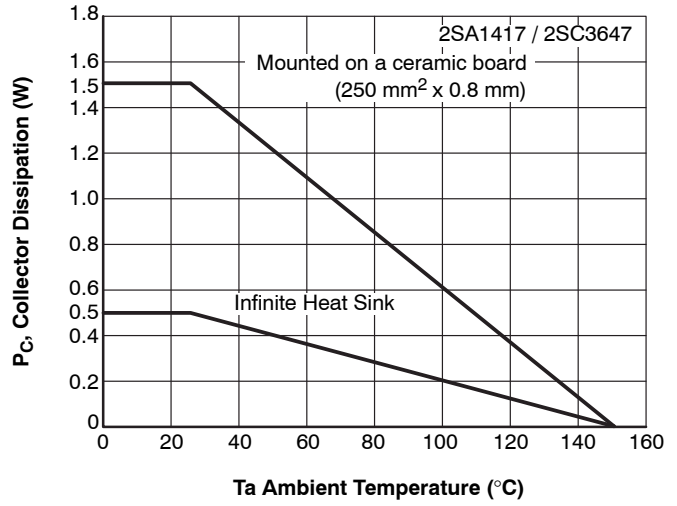

Figure 17. $P_C - T_a$

MECHANICAL CASE OUTLINE
PACKAGE DIMENSIONS

ON Semiconductor®



SOT-89 / PCP-1
CASE 419AU
ISSUE O

DATE 30 APR 2012

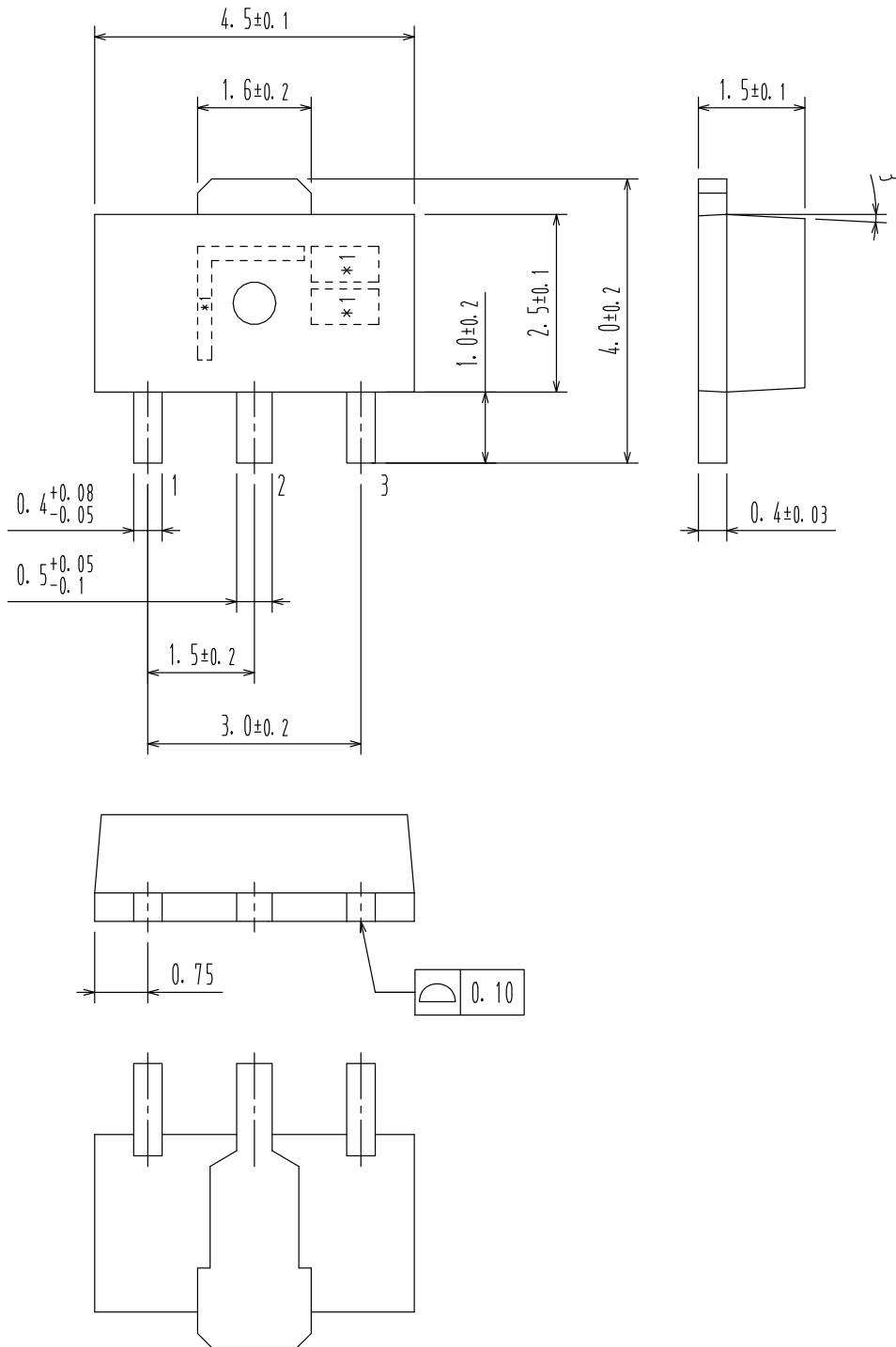

DOCUMENT NUMBER:	98AON79746E	Electronic versions are uncontrolled except when accessed directly from the Document Repository. Printed versions are uncontrolled except when stamped "CONTROLLED COPY" in red.
DESCRIPTION:	SOT-89 / PCP-1	PAGE 1 OF 1

ON Semiconductor and are trademarks of Semiconductor Components Industries, LLC dba ON Semiconductor or its subsidiaries in the United States and/or other countries. ON Semiconductor reserves the right to make changes without further notice to any products herein. ON Semiconductor makes no warranty, representation or guarantee regarding the suitability of its products for any particular purpose, nor does ON Semiconductor assume any liability arising out of the application or use of any product or circuit, and specifically disclaims any and all liability, including without limitation special, consequential or incidental damages. ON Semiconductor does not convey any license under its patent rights nor the rights of others.

onsemi, **Onsemi**, and other names, marks, and brands are registered and/or common law trademarks of Semiconductor Components Industries, LLC dba "**onsemi**" or its affiliates and/or subsidiaries in the United States and/or other countries. **onsemi** owns the rights to a number of patents, trademarks, copyrights, trade secrets, and other intellectual property. A listing of **onsemi**'s product/patent coverage may be accessed at www.onsemi.com/site/pdf/Patent-Marking.pdf. **onsemi** reserves the right to make changes at any time to any products or information herein, without notice. The information herein is provided "as-is" and **onsemi** makes no warranty, representation or guarantee regarding the accuracy of the information, product features, availability, functionality, or suitability of its products for any particular purpose, nor does **onsemi** assume any liability arising out of the application or use of any product or circuit, and specifically disclaims any and all liability, including without limitation special, consequential or incidental damages. Buyer is responsible for its products and applications using **onsemi** products, including compliance with all laws, regulations and safety requirements or standards, regardless of any support or applications information provided by **onsemi**. "Typical" parameters which may be provided in **onsemi** data sheets and/or specifications can and do vary in different applications and actual performance may vary over time. All operating parameters, including "Typicals" must be validated for each customer application by customer's technical experts. **onsemi** does not convey any license under any of its intellectual property rights nor the rights of others. **onsemi** products are not designed, intended, or authorized for use as a critical component in life support systems or any FDA Class 3 medical devices or medical devices with a same or similar classification in a foreign jurisdiction or any devices intended for implantation in the human body. Should Buyer purchase or use **onsemi** products for any such unintended or unauthorized application, Buyer shall indemnify and hold **onsemi** and its officers, employees, subsidiaries, affiliates, and distributors harmless against all claims, costs, damages, and expenses, and reasonable attorney fees arising out of, directly or indirectly, any claim of personal injury or death associated with such unintended or unauthorized use, even if such claim alleges that **onsemi** was negligent regarding the design or manufacture of the part. **onsemi** is an Equal Opportunity/Affirmative Action Employer. This literature is subject to all applicable copyright laws and is not for resale in any manner.

PUBLICATION ORDERING INFORMATION

LITERATURE FULFILLMENT:

Email Requests to: orderlit@onsemi.com

onsemi Website: www.onsemi.com

TECHNICAL SUPPORT

North American Technical Support:

Voice Mail: 1 800-282-9855 Toll Free USA/Canada

Phone: 011 421 33 790 2910

Europe, Middle East and Africa Technical Support:

Phone: 00421 33 790 2910

For additional information, please contact your local Sales Representative