

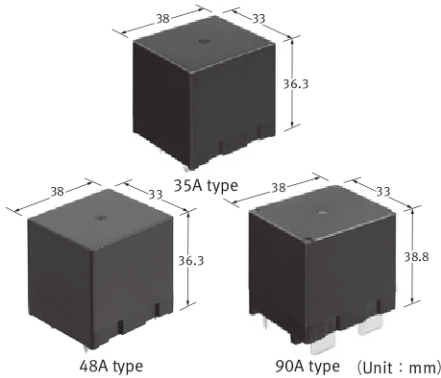

**Compact size,  
1 Form A 35A/48A/90A  
power relays  
for solar inverter**

# HE RELAYS PV Type

Protective construction : Flux-resistant type



## FEATURES

- High capacity and compact size**  
**High capacity control possible (35A/48A/90A type)**  
**35A/48A type: L: 33 × W: 38 × H: 36.3mm L: 1.299 × W: 1.496 × H: 1.429inch**  
**90A type: L: 33 × W: 38 × H: 38.8mm L: 1.299 × W: 1.496 × H: 1.528inch**  
**Due to improved conduction efficiency, wide terminal blades are used (for 48A and 90A type)**

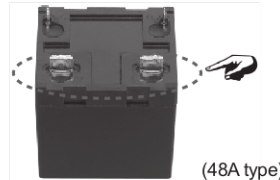

- Contact GAP**  
 Compliant with European photovoltaic standard VDE0126  
 Compliant with EN61810-1 2.5kW surge breakdown voltage (between contacts)  
 35A/48A type: 2.5mm .098inch  
 90A type: 3.0mm .118inch

- Contributes to energy saving in devices thanks to reduced coil hold voltage**  
**Coil hold voltage can be reduced down 40% of the nominal coil voltage (ambient temperature 20°C 68°F)**  
**This is equal to operating power of approximately 310mW.**  
\*Coil hold voltage is the coil voltage after 100ms following application of the nominal coil voltage.
- High insulation and 10,000V surge breakdown voltage (between contacts and coil)**

## TYPICAL APPLICATIONS

- Inverter (Solar and industrial)
- UPS
- Stationary charging stand

## ORDERING INFORMATION

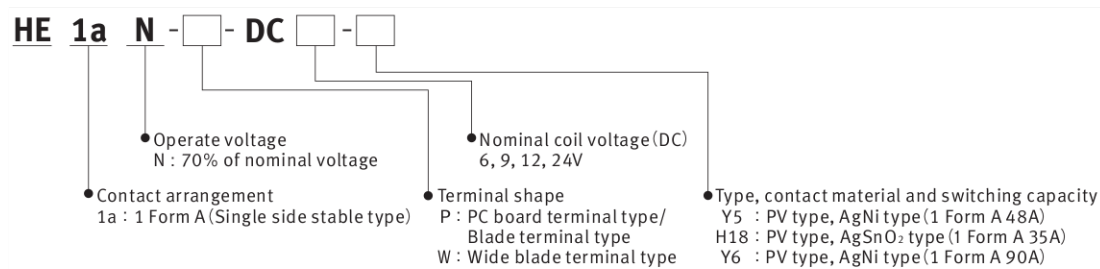

## TYPES

Type	Nominal coil voltage	Contact arrangement	Part No.
35A*	6V DC	1 Form A	HE1aN-P-DC6V-H18
	9V DC		HE1aN-P-DC9V-H18
	12V DC		HE1aN-P-DC12V-H18
	24V DC		HE1aN-P-DC24V-H18
48A	6V DC		HE1aN-P-DC6V-Y5
	9V DC		HE1aN-P-DC9V-Y5
	12V DC		HE1aN-P-DC12V-Y5
	24V DC		HE1aN-P-DC24V-Y5
90A	6V DC		HE1aN-W-DC6V-Y6
	9V DC		HE1aN-W-DC9V-Y6
	12V DC		HE1aN-W-DC12V-Y6
	24V DC		HE1aN-W-DC24V-Y6

Standard packing: Carton: 25 pcs.; Case: 100 pcs.

\*35A 6V, 12V and 24V DC type: Certified by UL/C-UL (35A 9V type: Certified by UL/C-UL and VDE)

## RATING

### 1. Coil data

- Operating characteristics such as 'Operate voltage' and 'Release voltage' are influenced by mounting conditions, ambient temperature, etc. Therefore, please use the relay within  $\pm 5\%$  of rated coil voltage.
- 'Initial' means the condition of products at the time of delivery.

Nominal coil voltage	Pick-up voltage (at 20°C 68°F) (Initial)	Drop-out voltage (at 20°C 68°F) (Initial)	Nominal operating current [ $\pm 10\%$ ] (at 20°C 68°F)	Coil resistance [ $\pm 10\%$ ] (at 20°C 68°F)	Nominal operating power	Max. applied voltage (at 20°C 68°F)
6V DC	70%V or less of nominal voltage	10%V or more of nominal voltage	320mA	18.8Ω	1,920mW	110%V of nominal voltage
9V DC			213mA	42.2Ω		
12V DC			160mA	75.0Ω		
24V DC			80mA	300.0Ω		

## 2. Specifications

Characteristics	Item	Specifications		
		35A type	48A type	90A type
Contact	Arrangement	1 Form A		
	Contact resistance (Initial)	Max. 100 mΩ (By voltage drop 6V DC 1A)		Max. 10 mΩ (By voltage drop 5V DC 20A)
	Contact material	AgSnO <sub>2</sub> type	AgNi type	
Rating	Nominal switching capacity	35A 277V AC (Resistive load)	48 A 277V AC (Resistive load)	80A 277V AC (Resistive load)
	Contact carrying power	9,695VA (Resistive load)	13,296VA (Resistive load)	24,930VA (Resistive load)
	Max. switching voltage	277V AC		
	Max. switching current	35A (AC)	48A (AC)	90A (AC)
	Nominal operating power	1,920mW		
	Min. switching capacity (Reference value)* <sup>1</sup>	100mA 5V DC		
Electrical characteristics	Insulation resistance (Initial)	Min. 1,000MΩ (at 500V DC) Measurement at same location as "Breakdown voltage" section.		
	Breakdown voltage (Initial)	Between open contacts	2,000 Vrms for 1 min. (Detection current: 10mA)	
		Between contact and coil	5,000 Vrms for 1 min. (Detection current: 10mA)	
	Surge breakdown voltage* <sup>2</sup> (Between contact and coil)	10,000 V (Initial)		
	Temperature rise	Max. 60°C 140°F (By resistive method, contact carrying current: 35A, 100%V of nominal coil voltage at 55°C 131°F.)	Max. 60°C 140°F (By resistive method, contact carrying current: 48A, 100%V of nominal coil voltage at 55°C 131°F.)	Max. 60°C 140°F (By resistive method, contact carrying current: 90A, 100%V of nominal coil voltage at 55°C 131°F.)
		Max. 30°C 86°F (By resistive method, contact carrying current: 35A, 60%V of nominal coil voltage at 85°C 185°F.)	Max. 30°C 86°F (By resistive method, contact carrying current: 48A, 60%V of nominal coil voltage at 85°C 185°F.)	Max. 30°C 86°F (By resistive method, contact carrying current: 90A, 60%V of nominal coil voltage at 85°C 185°F.)
	Coil hold voltage* <sup>3</sup>	40 to 100%V (Contact carrying current: 35A, at 20°C 68°F), 50 to 100%V (Contact carrying current: 35A, at 55°C 131°F), 50 to 60%V (Contact carrying current: 35A, at 85°C 185°F)	40 to 100%V (Contact carrying current: 48A, at 20°C 68°F), 50 to 100%V (Contact carrying current: 48A, at 55°C 131°F), 50 to 60%V (Contact carrying current: 48A, at 85°C 185°F)	40 to 100%V (Contact carrying current: 90A, at 20°C 68°F), 50 to 60%V (Contact carrying current: 90A, at 85°C 185°F)
	Operate time (at 20°C 68°F)	Max. 30 ms (nominal coil voltage, excluding contact bounce time)		
	Release time (at 20°C 68°F)* <sup>5</sup>	Max. 10 ms (nominal coil voltage, excluding contact bounce time) (without diode)		
	Mechanical characteristics	Shock resistance	Functional	98 m/s <sup>2</sup> (Half-wave pulse of sine wave: 11 ms; detection time: 10 μs.)
Destructive			980 m/s <sup>2</sup> (Half-wave pulse of sine wave: 6 ms.)	
Vibration resistance		Functional	10 to 55 Hz at double amplitude of 1.0 mm (Detection time: 10 μs.)	
		Destructive	10 to 55 Hz at double amplitude of 1.5 mm	
Expected life	Mechanical	Min. 10 <sup>7</sup> (at 180 times/min.)		Min. 1×10 <sup>6</sup> (at 180 times/min.)
	Electrical	Resistive load	Min. 3×10 <sup>4</sup> (35A 277V AC) (ON : OFF = 1s : 9s, at 85°C 185°F)	Min. 3×10 <sup>4</sup> (48A 277V AC) (ON : OFF = 1s : 9s, at 85°C 185°F)
Conditions	Conditions for operation, transport and storage* <sup>4</sup>	Ambient temperature: -50 to +55°C -58 to +131°F (When nominal coil voltage applied) -50 to +85°C -58 to +185°F (When applied coil hold voltage is 50% to 60% of nominal coil voltage) Humidity: 5 to 85% R.H. (Not freezing and condensing at low temperature); Air pressure: 86 to 106 kPa		
	Max. operating speed	6 times/min. (at nominal switching capacity ON : OFF = 1s : 9s)		
Unit weight		Approx. 80 g 2.82 oz		Approx. 85 g 3.00 oz

Notes: \*1. This value can change due to the switching frequency, environmental conditions, and desired reliability level, therefore it is recommended to check this with the actual load.

\*2. Wave is standard shock voltage of ±1.2×50μs according to JEC-212-1981

\*3. Coil hold voltage is the coil voltage after 100 ms following application of the nominal coil voltage.

\*4. The upper operation ambient temperature limit is the maximum temperature that can satisfy the coil temperature rise value. Refer to Usage, transport and storage conditions in NOTES.

\*5. Release time will lengthen if a diode, etc., is connected in parallel to the coil. Be sure to verify operation under actual conditions.

REFERENCE DATA

1.-(1) Coil temperature rise (35A type)

Tested sample : HE1aN-P-9V DC-H18, 6 pcs.  
 Measured portion : Coil inside  
 Contact carrying current : 35A  
 Ambient temperature : 25°C, 60°C, 85°C

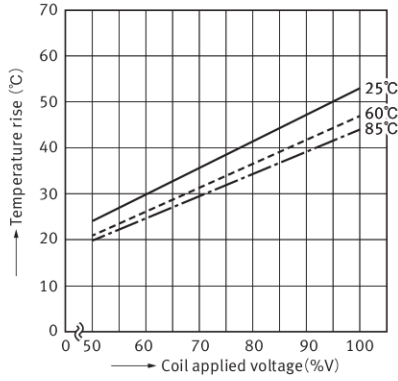

1.-(2) Coil temperature rise (48A type)

Tested sample : HE1aN-P-9V DC-Y5, 6 pcs.  
 Measured portion : Coil inside  
 Contact carrying current : 48A  
 Ambient temperature : 25°C, 60°C, 85°C

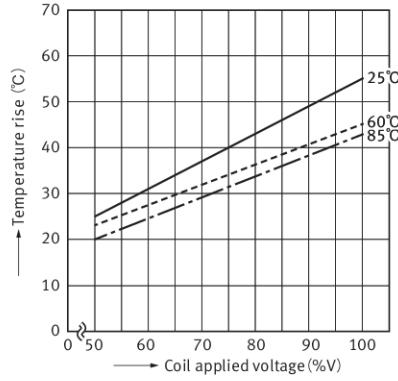

1.-(3) Coil temperature rise (90A type)

Tested sample : HE1aN-W-12V DC-Y6, 6 pcs.  
 Measured portion : Coil inside  
 Contact carrying current : 90A  
 Ambient temperature : 25°C, 60°C, 85°C

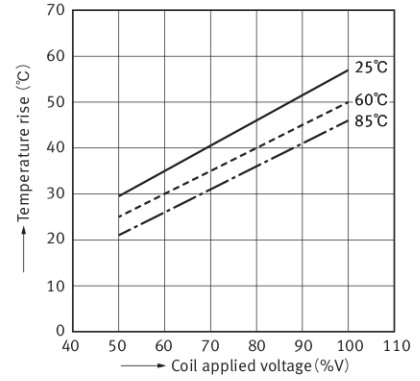

2.-(1) Electrical life test (35A type) (Resistive load 277V AC, 35A at 85°C 185°F)

Tested sample : HE1aN-P-9V DC-H18, 6 pcs.  
 Operation frequency : 6 times/min.  
 (ON : OFF=1s : 9s)

Circuit :

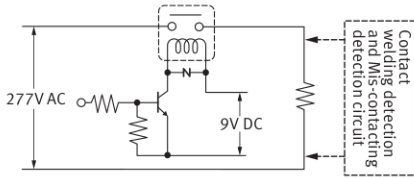

Operate and release voltage

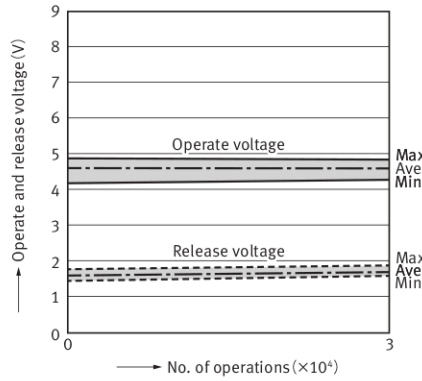

Change of contact resistance

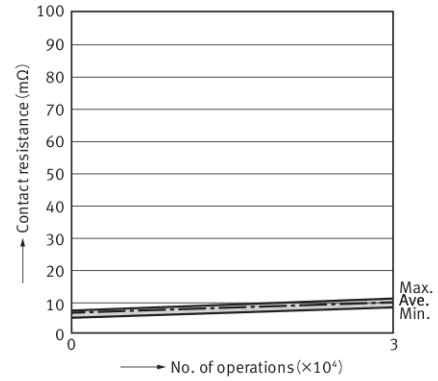

2.-(2) Electrical life test (48A type) (Resistive load 277V AC, 48A at 85°C 185°F)

Tested sample : HE1aN-P-9V DC-Y5, 6 pcs.  
 Operation frequency : 6 times/min.  
 (ON : OFF=1s : 9s)

Circuit :

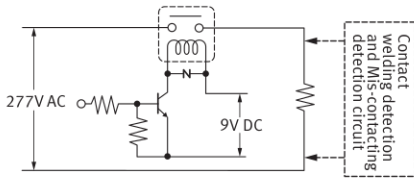

Operate and release voltage

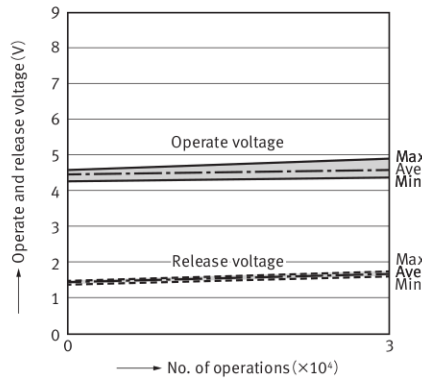

Change of contact resistance

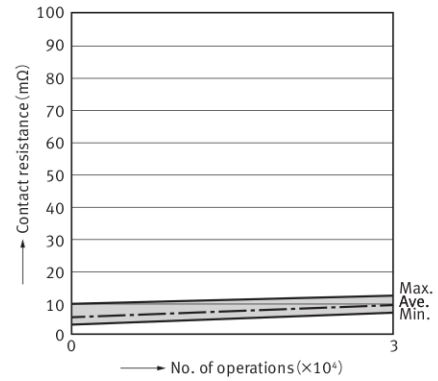

2.-(3) Electrical life test (90A type) (Resistive load 277V AC, 80A at 25°C 77°F)

Tested sample : HE1aN-W-12V DC-Y6, 6 pcs.  
 Operation frequency : 6 times/min.  
 (ON : OFF=1s : 9s)

Circuit :

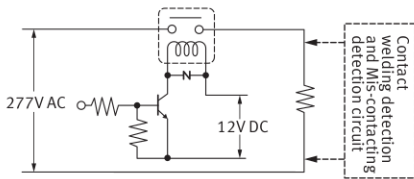

Operate and release voltage

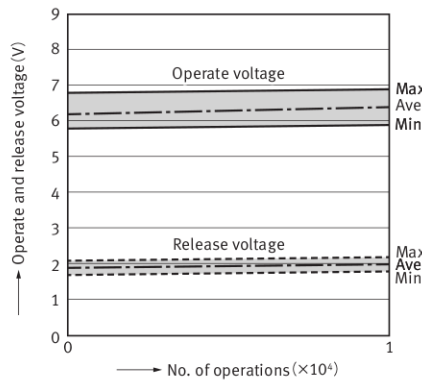

Change of contact resistance

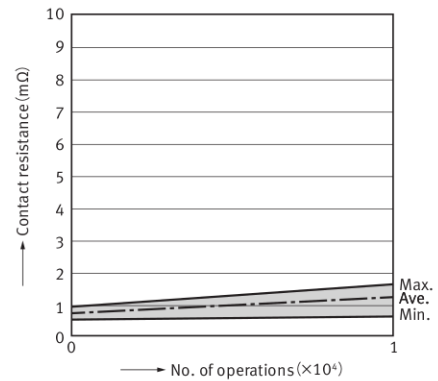

**DIMENSIONS** (mm)

**CAD** The CAD data of the products with a "CAD" mark can be downloaded from our Website.

**1. 35A type**

**CAD**

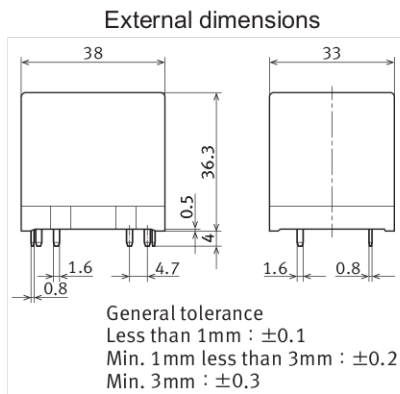

Schematic (Bottom view)  
Single side stable type

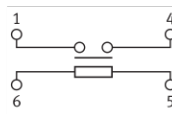

PC board pattern (Bottom view)

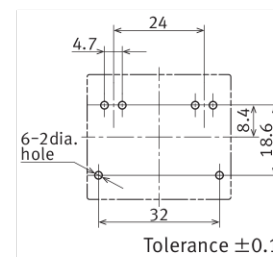

**2. 48A type**

**CAD**

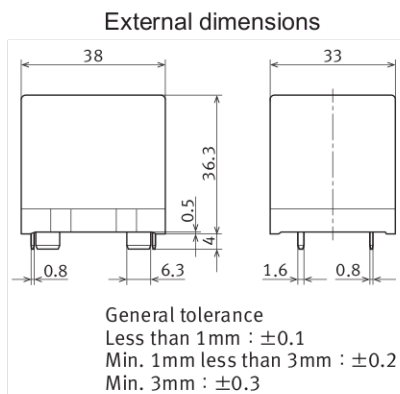

Schematic (Bottom view)  
Single side stable type

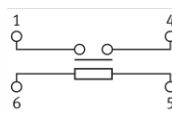

PC board pattern (Bottom view)

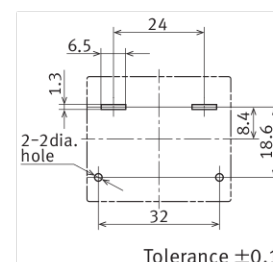

**3. 90A type**

**CAD**

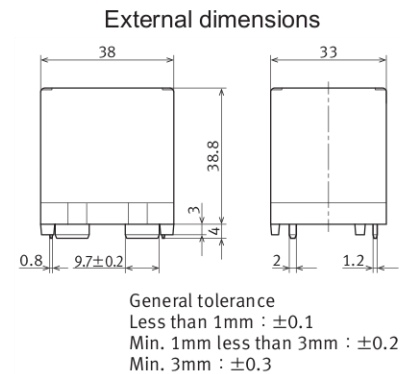

Schematic (Bottom view)  
Single side stable type

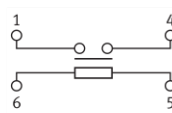

PC board pattern (Bottom view)

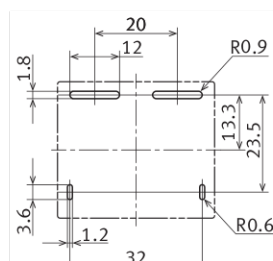

**SAFETY STANDARDS**

Type	Certification authority	File No.	Contact rating
90A	UL/C-UL*	E43028	80A 300V AC (general use 10k cycles)
			80A 300V AC (general use at 85°C 185°F, 6k cycles) in use at 60% of rated coil voltage
	VDE (VDE0435)	40006681	80A 250V AC cosφ = 1 (at 25°C 77°F, 10k cycles)
			90A 250V AC cosφ = 0.8 (at 85°C 185°F, 1k cycles)
			80A 250V AC cosφ = 0.8 (at 85°C 185°F, 10k cycles)
			90A 300V AC cosφ = 1 (at 85°C 185°F, 1k cycles)
48A	UL/C-UL	E43028	48A 277V AC (general use, at 85°C 185°F, 30k cycles) in use at 60% of rated coil voltage
			60A 277V AC (general use, at 60°C 140°F, 10k cycles), in use at 60% of rated coil voltage
	VDE (VDE0435)	40006681	48A 250V AC cosφ = 0.8 (at 85°C 185°F, 30k cycles)
			72A 250V AC (cosφ = 0.8 at 85°C 185°F, 50 cycles)
			60A 250V AC (cosφ = 0.8 at 85°C 185°F, 10k cycles)
			50A 20V DC (0ms, at 85°C 185°F, 30k cycles)
35A	UL/CSA	E43028	35A 277V AC (10k cycles), 30A 277V AC (100k cycles), 30A 30V DC (100k cycles), 1.5HP 125V AC (100k cycles), 3HP 250V AC (100k cycles), TV-15
	VDE (VDE0435)**	40006681	35A 250V AC cosφ = 1 (at 80°C 176°F, 50k cycles)

\* CSA standard: Certified by C-UL

\*\* Only 9V DC type is Certified by VDE

## NOTES

1. For cautions for use, please read "GENERAL APPLICATION GUIDELINES".

2. Usage, transport and storage conditions

1) Temperature:

-50 to +55°C -58 to +131°F

-50 to +85°C -58 to +185°F (When applied coil hold voltage is 50% to 60% of nominal coil voltage)

2) Humidity: 5 to 85% RH

(Avoid freezing and condensation.)

The humidity range varies with the temperature. Use within the range indicated in the graph below.

3) Atmospheric pressure: 86 to 106 kPa

Temperature and humidity range for usage, transport, and storage

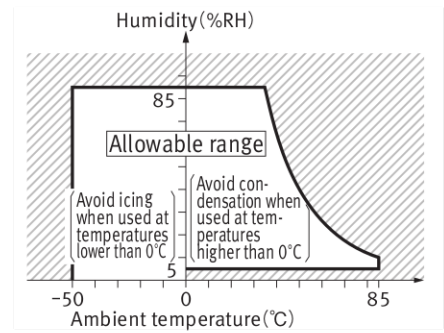
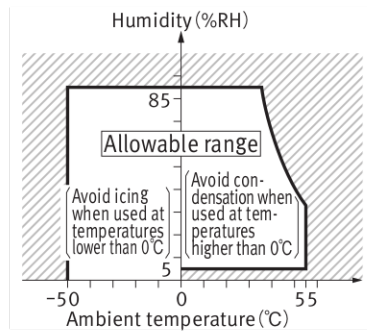

\* -50 to +85°C -58 to +185°F (When applied coil hold voltage is 50% to 60% of nominal coil voltage)

Please refer to "the latest product specifications" when designing your product.

• Requests to customers :

<https://industrial.panasonic.com/ac/e/salespolicies/>

# GUIDELINES FOR POWER RELAYS AND HIGH-CAPACITY DC CUT OFF RELAYS USAGE

For cautions for use, please read "GUIDELINES FOR RELAY USAGE".

[https://industrial.panasonic.com/ac/e/control/relay/cautions\\_use/index.jsp](https://industrial.panasonic.com/ac/e/control/relay/cautions_use/index.jsp)

## Precautions for Coil Input

### ■ Long term current carrying

A circuit that will be carrying a current continuously for long periods without relay switching operation. (circuits for emergency lamps, alarm devices and error inspection that, for example, revert only during malfunction and output warnings with form B contacts) Continuous, long-term current to the coil will facilitate deterioration of coil insulation and characteristics due to heating of the coil itself.

For circuits such as these, please use a magnetic-hold type latching relay. If you need to use a single stable relay, use a sealed type relay that is not easily affected by ambient conditions and make a failsafe circuit design that considers the possibility of contact failure or disconnection.

### ■ DC Coil operating power

Steady state DC current should be applied to the coil. The wave form should be rectangular. If it includes ripple, the ripple factor should be less than 5%.

However, please check with the actual circuit since the electrical characteristics may vary. The rated coil voltage should be applied to the coil and the set/reset pulse time of latching type relay differs for each relays, please refer to the relay's individual specifications.

### ■ Coil connection

When connecting coils of polarized relays, please check coil polarity (+,-) at the internal connection diagram (Schematic). If any wrong connection is made, it may cause unexpected malfunction, like abnormal heat, fire and so on, and circuit do not work. Avoid impressing voltages to the set coil and reset coil at the same time.

## Ambient Environment

### ● Usage, Transport, and Storage Conditions

During usage, storage, or transportation, avoid locations subjected to direct sunlight and maintain normal temperature, humidity and pressure conditions.

### ● Temperature/Humidity/Pressure

When transporting or storing relays while they are tube packaged, there are cases the temperature may differ from the allowable range. In this case be sure to check the individual specifications. Also allowable humidity level is influenced by temperature, please check charts shown below and use relays within mentioned conditions. (Allowable temperature values differ for each relays, please refer to the relay's individual specifications.)

#### 1) Temperature:

The tolerance temperature range differs for each relays, please refer to the relay's individual specifications

#### 2) Humidity:

5 to 85 % RH

#### 3) Pressure:

86 to 106 kPa

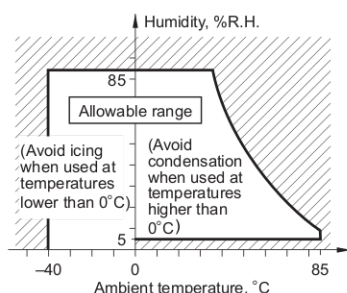

### ■ Maximum allowable voltage and temperature rise

Proper usage requires that the rated coil voltage be impressed on the coil. Note, however, that if a voltage greater than or equal to the maximum continuous voltage is impressed on the coil, the coil may burn or its layers short due to the temperature rise. Furthermore, do not exceed the usable ambient temperature range listed in the catalog.

### ■ Operate voltage change due to coil temperature rise (Hot start)

In DC relays, after continuous passage of current in the coil, if the current is turned OFF, then immediately turned ON again, due to the temperature rise in the coil, the pick-up voltage will become somewhat higher. Also, it will be the same as using it in a higher temperature atmosphere. The resistance/temperature relationship for copper wire is about 0.4% for 1°C, and with this ratio the coil resistance increases. That is, in order to operate of the relay, it is necessary that the voltage be higher than the pick-up voltage and the pick-up voltage rises in accordance with the increase in the resistance value. However, for some polarized relays, this rate of change is considerably smaller.

### ● Dew condensation

Condensation occurs when the ambient temperature drops suddenly from a high temperature and humidity, or the relay is suddenly transferred from a low ambient temperature to a high temperature and humidity. Condensation causes the failures like insulation deterioration, wire disconnection and rust etc. Panasonic Corporation does not guarantee the failures caused by condensation.

The heat conduction by the equipment may accelerate the cooling of device itself, and the condensation may occur. Please conduct product evaluations in the worst condition of the actual usage. (Special attention should be paid when high temperature heating parts are close to the device. Also please consider the condensation may occur inside of the device.)

### ● Icing

Condensation or other moisture may freeze on relays when the temperature become lower than 0°C. This icing causes the sticking of movable portion, the operation delay and the contact conduction failure etc. Panasonic Corporation does not guarantee the failures caused by the icing.

The heat conduction by the equipment may accelerate the cooling of relay itself and the icing may occur. Please conduct product evaluations in the worst condition of the actual usage.

### ● Low temperature and low humidity

The plastic becomes brittle if the switch is exposed to a low temperature, low humidity environment for long periods of time.

### ● High temperature and high humidity

Storage for extended periods of time (including transportation periods) at high temperature or high humidity levels or in atmospheres with organic gases or sulfide gases may cause a sulfide film or oxide film to form on the surfaces of the contacts and/or it may interfere with the functions. Check out the atmosphere in which the units are to be stored and transported.

# GUIDELINES FOR POWER RELAYS AND HIGH-CAPACITY DC CUT OFF RELAYS USAGE

## •Package

In terms of the packing format used, make every effort to keep the effects of moisture, organic gases and sulfide gases to the absolute minimum.

## •Silicon

When a source of silicone substances (silicone rubber, silicone oil, silicone coating materials and silicone filling materials etc.) is used around the relay, the silicone gas (low molecular siloxane etc.) may be produced.

This silicone gas may penetrate into the inside of the relay. When the relay is kept and used in this condition, silicone compound may adhere to the relay contacts which may cause the contact failure. Do not use any sources of silicone gas around the relay (Including plastic seal types).

## •NOx Generation

When relay is used in an atmosphere high in humidity to switch a load which easily produces an arc, the NOx created by the arc and the water absorbed from outside the relay combine to produce nitric acid. This corrodes the internal metal parts and adversely affects operation. Avoid use at an ambient humidity of 85%RH or higher (at 20°C). If use at high humidity is unavoidable, please contact our sales representative.

## Others

### ■ Cleaning

- 1) Although the environmentally sealed type relay (plastic sealed type, etc.) can be cleaned, avoid immersing the relay into cold liquid (such as cleaning solvent) immediately after soldering. Doing so may deteriorate the sealing performance.
- 2) Cleaning with the boiling method is recommended(The temperature of cleaning liquid should be 40°C or lower ).  
Avoid ultrasonic cleaning on relays. Use of ultrasonic cleaning may cause breaks in the coil or slight sticking of the contacts due to ultrasonic energy.

Please refer to **"the latest product specifications"** when designing your product.

•Requests to customers:

<https://industrial.panasonic.com/ac/e/salespolicies/>



---

Please contact .....

**Panasonic Corporation**

Electromechanical Control Business Division

■ 1006, Oaza Kadoma, Kadoma-shi, Osaka 571-8506, Japan  
[industrial.panasonic.com/ac/e/](http://industrial.panasonic.com/ac/e/)

**Panasonic**<sup>®</sup>

©Panasonic Corporation 2019