

Advanced **sensor technologies**
for today's breakthrough applications

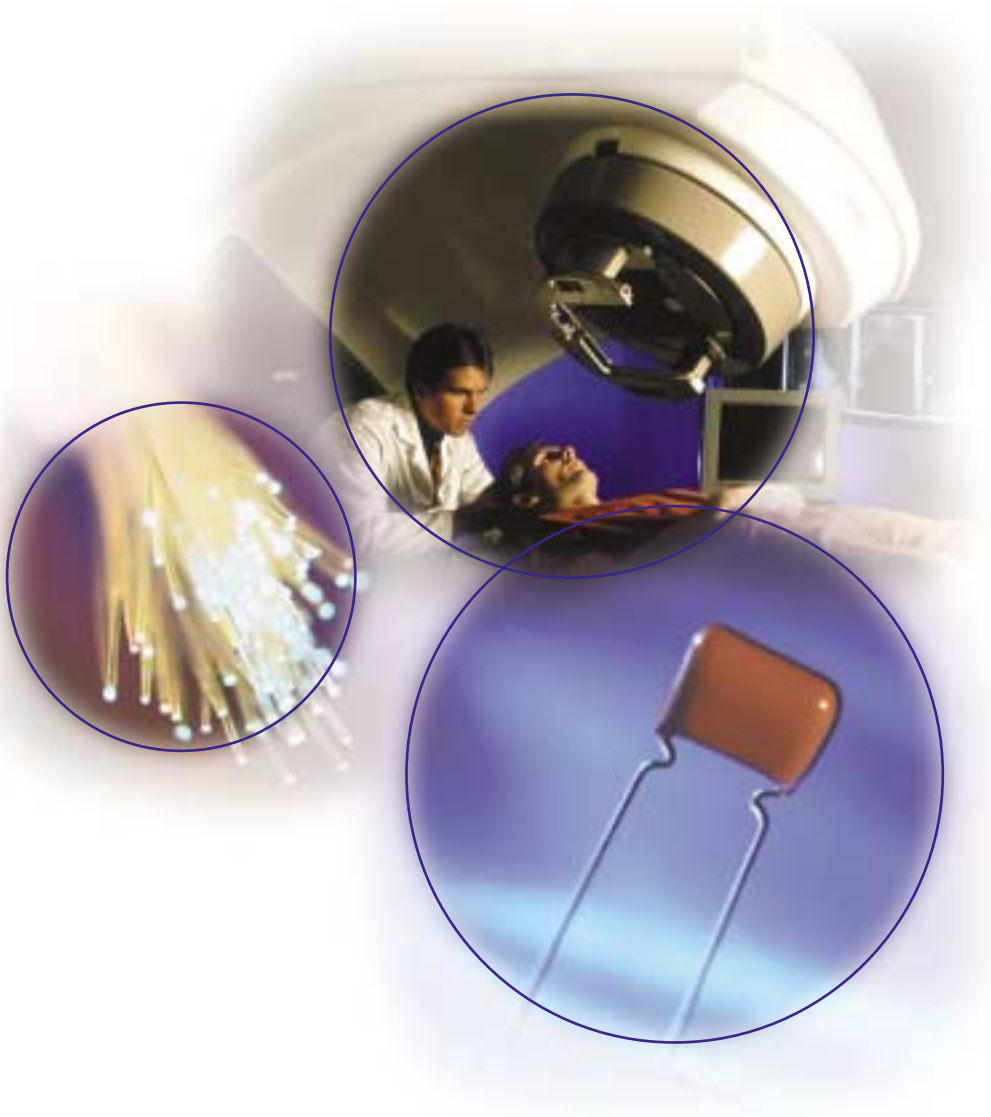

PerkinElmer Optoelectronics provides Digital Imaging, Sensor and Lighting technologies to speed the development of breakthrough applications for customers in biomedical, communications and industrial markets. With development and manufacturing centers around the world, the company is able to leverage and align global resources to serve customers through innovation and operational excellence.

Consistent with PerkinElmer Optoelectronics' policy of continually updating and improving its products, the type designation and data are subject to change, unless otherwise arranged. No obligations are assumed for notice of change of future manufacture of these devices or materials.

Copyright©2002 PerkinElmer Optoelectronics. All rights reserved.

Information furnished by PerkinElmer Optoelectronics is believed to be accurate and reliable. However, no responsibility is assumed by PerkinElmer Optoelectronics for its use; nor for any infringements of patents or other rights of third parties which may result from its use. No license is granted by implication or otherwise under any patent or patent right of PerkinElmer, Inc.

table of contents

Photo Detectors

Photon Counting Modules	2
Channel Photomultipliers	4
Photodiodes	8
Photocells	16
Ultraviolet Detectors	20
Thermopile Detectors	22
Pyroelectric Infrared Detectors	24
Analog Optical Isolators	26
Infrared Interruptive Switches	28
Phototransistors	30

Imaging Components

Buffered Multiplexers	32
Image Tubes	33
Line Scan Imagers	34
CMOS Photodiode Arrays	36
Cooled CCD Arrays	38
TDI Imagers	40

Solid State Emitters

Infrared Emitting Diodes	42
Laser Diodes	44

Medical Sensors	46
------------------------------	----

photon counting modules

- **Features**
- Peak Photon-Detection Efficiency @ 650 nm: 70% Typical
 - Active Area: SPCM-AQR-1X: 175 μm
 - Timing Resolution of 350 ps FWHM
 - User Friendly
 - Gated Input
 - Single +5 V Supply

- **Typical Applications**
- LIDAR
 - Photon-Correlation Spectroscopy
 - Astronomical Observation
 - Optical Range Finding
 - Adaptive Optics
 - Ultra-Sensitive Fluorescence
 - Particle Sizing

Datasheets available upon request

Description

PerkinElmer Optoelectronics provides photon-counting modules based on both APDs and innovative Channel Photomultipliers.

APD Based Single-Photon Counting Modules

The Single-Photon Counting Module (SPCM) is a self-contained photon counter which covers the wavelength range from 400 nm to 1100 nm, with photon detection efficiencies exceeding 70% at 630 nm. It has an integral 2-stage TE cooler, cooler controller, amplifier, discriminator and TTL output driver. It also contains a high-voltage DC-to-DC converter and is powered from a single 5 V source. The module utilizes a patented active-quench circuit which allows it to count over 10 million photons per second. The photosensitive area is 0.2 mm, and units are available with dark-count rates less than 25 counts/second.

SPCM-AQ4C Single-Photon Counting Array

The SPCM-AQ4C is a 4-channel photon-counting card capable of detecting single photons of light over a wavelength range from 400 nm to 1160 nm. Each channel is independent from the others. The SPCM-AQ4C utilizes a unique silicon avalanche photodiode (SliK™) with a circular active area whose peak photon-detection efficiency exceeds 60% at 650 nm. Each photodiode is both thermoelectrically cooled and temperature controlled, ensuring stabilized performance despite changes in the ambient temperature.



Single-Photon Counting Module—SPCM

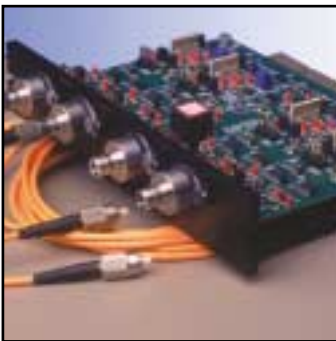

SPCM-AQ4C Single-Photon Counting Array

SPCM-AQR-1X Series

Technical Specification

Parameter	Typical	Parameter	Typical
Supply current	0.5 Amps	Supply voltage	5 V
Power cable total resistance	0.2 Ω	Case operating temperature	5-40°C
Active area (diameter) @ min. Pd	175 μ m		
Photon detection efficiency (Pd) @		Quantum efficiency	
400 nm	5%	400 nm	2%
650 nm	70%	650 nm	90%
830 nm	50%	830 nm	92%
1060 nm	2%	1060 nm	18%
Pd variation at constant case temperature (2 h @ 25° C)	± 1 - ± 3 %	Pd variation 5° C to 40° C case temperature	± 4 - ± 10 %
Dark count (cps) =		Dark count (cps) =	
SPCM-AQR-12	250-500	SPCM-AQR-15	50 max.
SPCM-AQR-13	150-250	SPCM-AQR-16	25 max.
SPCM-AQR-14	50-100		
Average dark count variation at constant case temperature (6 hrs @ 25°C)		Average dark count variation at 5°C to 40°C case temperature	
SPCM-AQR-12/13	± 10 % max.	SPCM-AQR-12/13	± 20 % max.
SPCM-AQR-14/15/16	$\pm 1\sigma$ max.	SPCM-AQR-14/15/16	$\pm 2\sigma$ max.
Single-photon timing resolution	350 ps @ FWHM	Dead time (Count rates below 5 Mc/s)	50 ns
Output count rate before saturation	15 Mc/s	Afterpulsing probability	0.3%
Linearity correction factor		Gating turn on/off (50 Ω output)	
@200 kc/s	1.01	Disable = TTL Low	2 ns
@1 Mc/s	1.08	Enable = TTL High	45 ns
@5 Mc/s	1.4		
Settling time following power up (1% stability) @ 1 meg counts/sec and 25°C	15 S	Threshold setting required on counter for digital output pulse (terminate in 50 Ω)	1 V
Gate threshold voltage: (@ $V_{\text{supply}} = 5$ V)		Gate threshold voltage: (@ $V_{\text{supply}} = 5$ V)	
Low level (sink current >90 mA)	0 V-0.4 V	High level (sink current >30 mA)	3.5-5.25 V

Test Conditions: T=22°C

SPCM-AQ4C

Technical Specification

Parameter	Typical	Parameter	Typical
Supply currents:		Maximum power consumption:	Counts/Second
@+2 V	1 Amp	@+2 V	6 Watts max.
@+5 V	0.25 Amps	@+5 V	5 Watts max.
@+30 V	0.01 Amps	@+30 V	1.2 Watts max.
Supply voltage		Photon detection efficiency (per channel)	
	1.95 V-2.05 V	@400 nm	5%
	4.75 V-5.25 V	@650 nm	65%
	29 V-31 V	@830 nm	25%
Operating temperature (heatsink)	5°C-40°C	Dark count (per channel)	1000 counts/sec.
Average dark count variation per channel @ constant heatsink temp.	10%	Average dark count variation per channel @ 5° to 40°C heatsink temp.	20%
Single-photon counting resolution	350 ps @ FWHM	Dead time	50 ns-60 ns
Output pulse width	30 ns	Maximum count rate	1 Mc/s-2 Mc/s
Continuous	1 Mc/s	Afterpulsing probability	0.3%
Gate threshold voltage: (@ $V_{\text{supply}} = 5$ V)		Gate threshold voltage: (@ $V_{\text{supply}} = 5$ V)	
Low level (sink current >90 mA)	0 V-0.4 V	High level (source current >30 mA)	3.5 V-5.25 V

Test Conditions: T=22°C

channel photomultipliers

▶ CPM Features

- Ultra-high anode sensitivity up to 10^7 A/W
- Extremely low dark current, typically 3 pA @ 10^6 gain
- Very low equivalent noise input (down to 10^{-17} W)
- High stability in dark current (“no bursts”)
- High gain exceeding 10^8
- Compact dimensions
- High dynamic range
- Wide spectral response through multiple window materials
- High resolution
- Fast response time
- High immunity to magnetic fields
- Rugged design

▶ Module Features

- High dynamic range
- No cooling required
- Very high stability in noise level
- Adjustable gain
- Active quenching circuit for high light protection
- Gateable CPM input (only Bialkali types)
- Optical fiber read-out possible
- 5 volts operating voltage
- Monitor voltage output

▶ Typical Applications

- Photon Detection and Counting
- Fluorescence Measurements
- Analytical and Clinical Instrumentation
- Bioluminescence
- High-Energy Physics

▶ Available Related Products

CPM:

- 1/3" C900 Series
- 1/2" C1300 Series
- 3/4" C1900 Series

CPM Modules:

- MD Series
- MP Series
- MH Series
- MP 96X-2, MP 97X-2

High Voltage Power Supply:

- CHV 30N
- CHV 30P

Datasheets available upon request

Description

PerkinElmer Optoelectronics' Channel Photomultiplier (CPM) is an ultra-high sensitivity optical detector capable of replacing conventional photomultipliers (PMTs). This device uses a proprietary detector principle to produce ultra-high gain and dynamic range, extremely low noise, and fast response within a compact form factor. These detectors are available as components or in complete modules designed for DC operation and photon counting. All modules are gateable by an external TTL pulse for time-resolved measurements.

Modules

- MD Series DC-Module—contains the CPM, a high-voltage power supply, an amplifier with I/U conversion, and an active quenching circuit for high light protection.
- MP Series Photon Counting Module—The Photon Counting Head MP 900 contains the Channel Photomultiplier, a high-voltage power supply, a discrimination amplifier and a pulse shaper for fast output pulses.
- MH Series Channel Photomultiplier Head Module—The Channel Photomultiplier module MH 900 series is designed for both photon counting and dc operating modes. It contains an adjustable high-voltage supply and a Channel Photomultiplier of the C900 series.
- MP 96X-2, MP 97X-2 Single Photon Counting Module—These modules are specially designed for particle measurement with 530 nm and 632 nm lasers. Based on the standard multialkali photocathode, the sensitive diameter is reduced to 2 mm in order to achieve an excellent low dark-count performance.

Power Supply

- CHV 30N—A self-contained high-voltage supply specially designed for the Channel Photomultipliers CPM C900, C1300 and C1900. It provides the matching voltages for the cathode, channel entrance, and channel end.
- CHV 30P—The equivalent power supply for positive high voltage.

All given values are nominal/typical at 20°C ambient temperature; specifications are subject to change without notice.

Principle of Operation

The CPM converts a very low light level into photoelectrons through a semitransparent photocathode deposited on the inner surface of the entrance window. On their way from the cathode to the anode, the photoelectrons pass through a narrow semiconductive channel. Each time the electrons hit the inner surface of the curved channel, multiple secondary electrons are emitted. This effect occurs multiple times along the path, leading to an avalanche effect with a gain exceeding 10^8 . The curved shape of the glass tube improves the multiplication effect.



Channel Photomultipliers—
CPM Formats 1/2" and 3/4"

CPM—1/3" C 900 Series

Technical Specification

Spectral Response /nm	Model	@140 nm A/W	@200 nm A/W	@400 nm A/W	@560 nm A/W	ENI (W)	Dark Current pA	Model	Dark Counts per Second (cps)
115-200	C911	6x10 ⁵				1x10 ⁻¹⁷	2	C911P	0.1
115-200	C921		1x10 ⁶			1x10 ⁻¹⁷	10	C921P	1
165-320	C922		1x10 ⁶			1x10 ⁻¹⁷	10	C922P	1
165-650	C942			3x10 ⁶		1x10 ⁻¹⁷	80	C942P	10
185-650	C943			3x10 ⁶		1x10 ⁻¹⁷	80	C943P	10
300-650	C944			3x10 ⁶		1x10 ⁻¹⁷	80	C944P	10
165-750	C952			3x10 ⁶		2.5x10 ⁻¹⁷	250	C952P	40
185-750	C953			3x10 ⁶		2.5x10 ⁻¹⁷	250	C953P	40
165-850	C962				2x10 ⁶	4x10 ⁻¹⁷	1000	C962P	100
185-850	C963				2x10 ⁶	4x10 ⁻¹⁷	1000	C963P	100
165-900	C972				2x10 ⁶	1.5x10 ⁻¹⁶	5000	C972P	500
185-900	C973				2x10 ⁶	1.5x10 ⁻¹⁶	5000	C973P	500
165-650	C982			3x10 ⁵		6x10 ⁻¹⁸	25	C982P	3
185-650	C983			3x10 ⁵		6x10 ⁻¹⁸	25	C983P	3

Useful Area: Min. 5 mm

Window Material: MgF₂, Quartz or UV Glass

Electron Multiplication: Channel Electron Multiplier

Current Amplification: 5x10⁶

Bias Current (μA): 50

Anode Current: Max. 10 μA (Max. 30 sec.)

Single Photo Electron gain: 3x10⁶

Ambient Temperature (°C): Max. 50

Photocathode Material: CsI, CsTe, Low-noise Bialkali, Bialkali, Low-noise Multialk., Multialk. or Extended Red Multialk.

Supply Voltage (V): 2400 (Max. 3000)

Linear Anode Current: Max. (DC linearity limit) 10% of Bias Current

Response Time Rise Time (ns): 3

Pulse Width/FWHM (ns): 6

Peak to Valley: 10:1



Channel Photomultipliers—
CPM Format 1/3"

CPM—1/2" C 1300 Series

Technical Specification

Spectral Response /nm	Model	@140 nm A/W	@200 nm A/W	@400 nm A/W	@560 nm A/W	ENI (W)	Dark Current pA	Model	Dark Counts per Second (cps)
115-200	C1311	6x10 ⁵				2x10 ⁻¹⁷	8	C1311P	0.4
115-320	C1321		1x10 ⁶			2x10 ⁻¹⁷	40	C1321P	4
165-320	C1322		1x10 ⁶			2x10 ⁻¹⁷	40	C1322P	4
165-650	C1342			3x10 ⁶		2x10 ⁻¹⁷	320	C1342P	40
185-650	C1343			3x10 ⁶		2x10 ⁻¹⁷	320	C1343P	40
300-650	C 1344			3x10 ⁶		2x10 ⁻¹⁷	320	C1344P	40
165-750	C1352			3x10 ⁶		4x10 ⁻¹⁷	1000	C 1352P	160
185-750	C1353			3x10 ⁶		4x10 ⁻¹⁷	1000	C1353P	160
165-850	C1362				2x10 ⁶	8x10 ⁻¹⁷	4000	C1362P	400
185-850	C1363				2x10 ⁶	8x10 ⁻¹⁷	4000	C1363P	400
165-900	C1372				2x10 ⁶	3x10 ⁻¹⁶	20000	C1372P	2000
185-900	C1373				2x10 ⁶	3x10 ⁻¹⁶	20000	C1373P	2000
165-650	C1382			3x10 ⁶		1x10 ⁻¹⁷	100	C1382P	10
185-650	C1383			3x10 ⁶		1x10 ⁻¹⁷	100	C1383P	10

Useful Area: Min. 9 mm

Window Material: MgF₂, Quartz, UV Glass or Borosil.

Supply Voltage (V): 2400 (Max. 3000)

Bias Current (μA): 50

Response Time Rise Time (ns): 3

Pulse Width/FWHM (ns): 6

Peak to Valley: 10:1

Photocathode Material: CsI, CsTe, Low-noise Bialkali, Bialkali, Low-noise, Multialk., Multialk. or Extended Red Multialk.

Current Amplification: 5x10⁷

Linear Anode Current: Max. (DC linearity limit) 10% of Bias Current

Anode Current: Max. 10 μA (Max. 30 sec.)

Single Photoelectron gain: 3x10⁶

Ambient Temperature (°C): Max. 50

channel photomultipliers

CPM—3/4" C 1900 Series

Technical Specification

Spectral Response /nm	Model	@140 nm A/W	@200 nm AW	@400 nm A/W	@560 nm A/W	ENI (W)	Dark Current pA	Model	Dark Counts per Second (cps)
115-200	C1911	6x10 ⁶				3x10 ⁻¹⁷	20	C1911P	1
115-320	C1921		1x10 ⁶			3x10 ⁻¹⁷	100	C1921P	10
165-320	C1922		1x10 ⁶			3x10 ⁻¹⁷	100	C1922P	10
165-650	C1942			3x10 ⁶		3x10 ⁻¹⁷	800	C1942P	100
185-650	C1943			3x10 ⁶		3x10 ⁻¹⁷	800	C1943P	100
300-650	C1944			3x10 ⁶		3x10 ⁻¹⁷	800	C1944P	100
165-750	C1952			3x10 ⁶		8x10 ⁻¹⁷	2500	C1952P	400
185-750	C1953			3x10 ⁶		8x10 ⁻¹⁷	2500	C1953P	400
165-850	C1962				2x10 ⁶	1x10 ⁻¹⁶	10000	C1962P	1000
185-850	C1963				2x10 ⁶	1x10 ⁻¹⁶	10000	C1963P	1000
165-900	C1972				2x10 ⁶	5x10 ⁻¹⁶	50000	C1972P	5000
185-900	C1973				2x10 ⁶	5x10 ⁻¹⁶	50000	C1973P	5000
165-650	C1982			3x10 ⁶		2x10 ⁻¹⁷	250	C1982P	25
185-650	C1983			3x10 ⁶		2x10 ⁻¹⁷	250	C1983P	25

Useful Area: Min. 15 mm

Window Material: MgF₂, Quartz, UV Glass or Borosil.

Electron Multiplication: Channel Electron Multiplier

Current Amplification: 5x10⁷

Bias Current (μA): 50

Anode Current: Max. 10 μA (Max. 30 sec.)

Single Photoelectron gain: 3x10⁶

Ambient Temperature (°C): Max. 50

Photocathode Material: CsI, CsTe, Low-noise Bialkali, Bialkali, Low-noise Multialk., Multialk. or Extended Red Multialk.

Supply Voltage (V): 2400 (Max. 3000)

Linear Anode Current: Max. (DC linearity limit) 10% of Bias Current

Response Time Rise Time (ns): 3

Pulse Width/FWHM (ns): 6

Peak to Valley: 10:1



Power Supply
CHV30N, CHV30P

Power Supply—CHV30N

Technical Specification

Part Number	Voltage Channel Entrance	Voltage Cathode	Output Current	Long Term Stability typ.	Output Ripple typ.	Supply Voltage
CHV30N	-2900 V max.	-3000 V max.	100 μA max.	< 1E-5	< 50 mV _{pp}	5 V

Test conditions: T = 20°C

Voltage channel entrance: V_{SET}=0-2.9 V

Voltage cathode: V_{gate}=low or open

Long-term stability @ V_{SET}: <<1 E-5

Weight: 45 g

Operating temperature: 0-50°C

Storage temperature: -20-60°C

Power Supply—CHV30P

Technical Specification

Part Number	Voltage Anode	Voltage Cathode typ.	Voltage Channel Entrance typ.	Output Current	Long Term Stability typ.	Output Ripple typ.	Supply Voltage
CHV30P	+3000 V max.	0 V	140 V	100 μA max.	< 1E-5	< 30 mV _{pp}	5 V

Test conditions: T = 20°C

Voltage Anode: @ V_{SET}=0-3 V

Voltage cathode: 190 V—when gated

Voltage channel entrance: @ V_A ≥1400 V

Long-term stability @ V_{SET}: <<1 E-5

Weight: 45 g

Operating temperature: 0-50°C

Storage temperature: -20-60°C



CPM Module Formats
1/3", 1/2", 3/4"

CPM Module—1/3" 900 Series

Technical Specification

Spectral Response /nm	Dark Current/Offset Voltage @1x10 ⁶ Gain & 1 V/20 nA			Dark Counts per Second (cps)			Dark Current pA @5x10 ⁷ Gain			Dark Counts per Second (cps)		
	Model	ENI (W)		Model			Model	ENI (W)		Model	ENI (W)	
165-650	MD 942	1x10 ⁻¹⁷	3 pA/150 μV	MP 942	10		MH 942	80		MH 942P	1x10 ⁻¹⁷	10
185-650	MD 943	1x10 ⁻¹⁷	3 pA/150 μV	MP 943	10		MH 943	80		MH 943P	1x10 ⁻¹⁷	10
165-750	MD 952	2.5x10 ⁻¹⁷	10 pA/500 μV	MP 952	40		MH 952	250		MH 952P	2.5x10 ⁻¹⁷	40
185-750	MD 953	2.5x10 ⁻¹⁷	10 pA/500 μV	MP 953	40		MH 953	250		MH 953P	2.5x10 ⁻¹⁷	40
165-850	MD 962	4x10 ⁻¹⁷	30 pA/1.5 mV	MP 962 MP 962-2	100 40		MH 962	1000		MH 962P	4x10 ⁻¹⁷	100
185-850	MD 963	4x10 ⁻¹⁷	30 pA/1.5 mV	MP 963 MP 963-2	100 40		MH 963	1000		MH 963P	4x10 ⁻¹⁷	100
165-900	MD 972	1.5x10 ⁻¹⁶	200 pA/10 mV	MP 972 MP 972-2	500 160		MH 972	5000		MH 972P	1.5x10 ⁻¹⁶	400
185-900	MD 973	1.5x10 ⁻¹⁶	200 pA/10 mV	MP 973 MP 973-2	500 160		MH 973	5000		MH 973P	1.5x10 ⁻¹⁶	400
165-650	MD 982	6x10 ⁻¹⁸	1 pA/50 μV	MP 982	3		MH 982	25		MH 982P	6x10 ⁻¹⁸	3
185-650	MD 983	6x10 ⁻¹⁸	1 pA/50 μV	MP 983	3		MH 983	25		MH 983P	6x10 ⁻¹⁸	3

Photocathode Diameter: 5 mm (MP 9xx-2 types: 2 mm) Photocathode Material: Low-noise Bialkali, Bialkali, Low-noise Multialk., Multialk. or Extended Red Multialk.
Window Material: Quartz or UV Glass
Additional models on request
Quantum Efficiency: 20% typical (Ext. Red MA: 10% typical)

CPM Module—1/2" 1300 Series

Technical Specification

Spectral Response /nm	Dark Current/Offset Voltage @1x10 ⁶ Gain & 1 V/20 nA			Dark Counts per Second (cps)			Dark Current pA @5x10 ⁷ Gain			Dark Counts per Second (cps)		
	Model	ENI (W)		Model			Model	ENI (W)		Model	ENI (W)	
165-650	MD1342	2x10 ⁻¹⁷	12 pA/600 μV	MP1342	40		MH1342	320		MH1342P	2x10 ⁻¹⁷	40
185-650	MD1343	2x10 ⁻¹⁷	12 pA/600 μV	MP1343	40		MH1343	320		MH1343P	2x10 ⁻¹⁷	40
165-750	MD1352	4x10 ⁻¹⁷	40 pA/2 mV	MP1352	160		MH1352	1000		MH1352P	4x10 ⁻¹⁷	160
185-750	MD1353	4x10 ⁻¹⁷	40 pA/2 mV	MP1353	160		MH1353	1000		MH1353P	4x10 ⁻¹⁷	160
165-850	MD1362	8x10 ⁻¹⁷	120 pA/6 mV	MP1362	400		MH1362	4000		MH1362P	8x10 ⁻¹⁷	400
185-850	MD1363	8x10 ⁻¹⁷	120 pA/6 mV	MP1363	400		MH1363	4000		MH1363P	8x10 ⁻¹⁷	400
165-900	MD1372	3x10 ⁻¹⁶	800 pA/40 mV	MP1372	2000		MH1372	20000		MH1372P	3x10 ⁻¹⁶	2000
185-900	MD1373	3x10 ⁻¹⁶	800 pA/40 mV	MP1373	2000		MH1373	20000		MH1373P	3x10 ⁻¹⁶	2000
165-650	MD1382	1x10 ⁻¹⁷	4 pA/200 μV	MP1382	10		MH1382	100		MH1382P	1x10 ⁻¹⁷	10
185-650	MD1383	1x10 ⁻¹⁷	4 pA/200 μV	MP1383	10		MH1383	100		MH1383P	1x10 ⁻¹⁷	10

Photocathode Diameter: Min. 9 mm Photocathode Material: Low-noise Bialkali, Bialkali, Low-noise Multialk., Multialk. or Extended Red Multialk.
Window Material: Quartz or UV Glass
Additional models on request
Quantum Efficiency: 20% typical (Ext. Red MA: 10% typical)

CPM Module—3/4" 1900 Series

Technical Specification

Spectral Response /nm	Dark Current/Offset Voltage @1x10 ⁶ Gain & 1 V/20 nA			Dark Counts per Second (cps)			Dark Current pA @5x10 ⁷ Gain			Dark Counts per Second (cps)		
	Model	ENI (W)		Model			Model	ENI (W)		Model	ENI (W)	
165-650	MD1942	3x10 ⁻¹⁷	30 pA/1.5 mV	MP1942	100		MH 1942	800		MH 1942P	3x10 ⁻¹⁷	100
185-650	MD1943	3x10 ⁻¹⁷	30 pA/1.5 mV	MP1943	100		MH1943	800		MH1943P	3x10 ⁻¹⁷	100
165-750	MD1952	8x10 ⁻¹⁷	100 pA/5 mV	MP1952	400		MH1952	2500		MH1952P	8x10 ⁻¹⁷	400
185-750	MD1953	8x10 ⁻¹⁷	100 pA/5 mV	MP1953	400		MH1953	2500		MH1953P	8x10 ⁻¹⁷	400
165-850	MD1962	1x10 ⁻¹⁶	300 pA/15 mV	MP1962	1000		MH1962	10000		MH1962P	1x10 ⁻¹⁶	1000
185-850	MD1963	1x10 ⁻¹⁶	300 pA/15 mV	MP1963	1000		MH1963	10000		MH1963P	1x10 ⁻¹⁶	1000
165-900	MD1972	5x10 ⁻¹⁶	2 nA/100 mV	MP1972	5000		MH1972	50000		MH1972P	5x10 ⁻¹⁶	5000
185-900	MD1973	5x10 ⁻¹⁶	2 nA/100 mV	MP1973	5000		MH1973	50000		MH1973P	5x10 ⁻¹⁶	5000
165-650	MD1982	2x10 ⁻¹⁷	10 pA/500 μV	MP1982	25		MH1982	250		MH1982P	2x10 ⁻¹⁷	25
185-650	MD1983	2x10 ⁻¹⁷	10 pA/500 μV	MP1983	25		MH1983	250		MH1983P	2x10 ⁻¹⁷	25

Photocathode Diameter: Min. 15 mm Photocathode Material: Low-noise Bialkali, Bialkali, Low-noise Multialk., Multialk. or Extended Red Multialk.
Window Material: Quartz or UV Glass
Additional models on request
Quantum Efficiency: 20% typical (Ext. Red MA: 10% typical)



CPM Modules—
3/4" 1900 Series

photodiodes



Features

- Low-cost visible and near-IR photodetector
- Excellent linearity in output photocurrent over 7 to 9 decades of light intensity
- Fast response times
- Available in a wide range of packages including epoxy-coated, transfer-molded, cast, and hermetic packages, as well as in chip form
- Low noise
- Mechanically rugged, yet compact and lightweight
- Available as duals, quads or as linear arrays
- Usable with almost any visible or near-infrared light source such as solid state laser diodes, neon, fluorescent, incandescent bulbs, lasers, flame sources, sunlight, etc.
- Can be designed and tested to meet the requirements of your application



Typical Applications

- Fiber-Optic Communications
- Instrumentation
- High-Speed Switching
- Spot Position Tracking and Measurement
- Photometry
- Data Transmission
- UV Light Meters
- Fluorescent Light Detection
- Laser Range Finding
- Barcode Scanning
- Laser Safety Scanning
- Distance Measurement

Datasheets available upon request

Description

PerkinElmer Optoelectronics offers a broad array of Silicon and InGaAs PIN and APDs.

InGaAs Avalanche Photodiodes

The high-quality InGaAs avalanche photodiodes (APDs) are packaged in hermetically sealed TO cans and ceramic blocks designed for the 900 to 1700 nm wavelength region.

InGaAs PIN Photodiodes

High-quality Indium Gallium Arsenide photodiodes designed for the 900 to 1700 nm wavelength region, these photodiodes are available in standard sizes ranging from 50 microns to 5 mm in diameter. Packages include ceramic submount, TO packages, and chip form.

Silicon Avalanche Photodiodes

These are reliable, high-quality detectors in hermetically sealed TO packages designed for high-speed and high-gain applications. A “reach-through” structure is utilized which provides very low noise performance at high gains, and a full range of active areas is available.

Silicon PIN Photodiodes

Offered for low- to high-speed applications, these PINs are designed for the 250 nm to 1100 nm range. Standard sizes range from 100 microns to 10 mm in diameter.

Silicon PN Photodiodes

This format includes a variety of high-volume, low-cost silicon photodiodes that meet the demanding requirements of today’s commercial and consumer markets.

Alternate Source/Second Source Photodiodes

PerkinElmer’s nearest equivalent devices are selected on the basis of general similarity of electro-optical characteristics and mechanical configuration. Interchangeability in any particular application is not guaranteed, suitability should be determined by the customer’s own evaluation.

Detector Modules

Preamplifier modules are hybrid devices with a photodiode and a matching amplifier in a compact hermetic TO package. An integral amplifier allows for better ease of use and noise bandwidth performance. 14-pin, DIL, and/or fibered packaged modules are available on a custom basis.



**Indium Gallium Arsenide
PIN Photodiodes, Large-Area,
and Small-Area
Indium Gallium Arsenide APDs**

- High Responsivity
- Low Capacitance for High Bandwidths
- Available in Various Hermetic Packages

InGaAs APDs—900 nm to 1700 nm

Technical Specification

Part Number	Standard Package	Photo Sens. Diam. μm	Resp. A/W @1300 nm	Resp. A/W @1550 nm	Dark Curr. Id (nA)	Spect. Noise Curr. Dens. In (pA/ $\sqrt{\text{Hz}}$)	Cap. @100 kHz Cd (pF)	Bandwidth GHz into 50 W	NEP @ 1550 nm pW/ $\sqrt{\text{Hz}}$	VOP for Gain=10 V
C30644E	TO window	50	8.4	9.4	6	0.15	1	2	0.03	40-90
C30644ECER	Ceramic	50	8.4	9.4	6	0.15	0.8	2	0.03	40-90
C30645E	TO window	80	8.4	9.4	10	0.25	1.2	1	0.13	40-90
C30645ECER	Ceramic	80	8.4	9.4	10	0.25	1	1	0.13	40-90
C30662E	TO window	200	8.4	9.4	200	1.4	2.5	0.2	0.15	40-90
C30662ECER	Ceramic	200	8.4	9.4	200	1.4	2.5	0.2	0.15	40-90
C30733ECER	Ceramic	30	8.4	9.4	5	<0.1	0.25	3	0.01	40-90

Test conditions: T = 22°C

InGaAs PIN Large-Area—900 nm to 1700 nm

Technical Specification

Part Number	Standard Package	Photo Sens. Diam. mm	Resp. A/W @850 nm	Resp. A/W @1300 nm	Resp. A/W @1550 nm	Dark Curr. Id (nA)	NEP @ 1300 nm pW/ $\sqrt{\text{Hz}}$	Cap. @100 kHz Cd (pF)	Bandwidth MHz into 50 W	Max. Power for .15 dB Linearity (dBm)	Bias Volt for these Specs V
C30619G	TO-18	0.5	0.2	0.86	0.95	5	<0.1	8	350	>+13	5
C30641G	TO-18	1	0.2	0.86	0.95	5	<0.1	40	75	>+13	2
C30642G	TO-5	2	0.2	0.86	0.95	10	0.1	350	20	+11	0
C30665G	TO-5	3	0.2	0.86	0.95	25	0.2	1000	3	+11	0
C30723G	TO-8	5	0.2	0.86	0.95	30	0.3	2500	2.5	+11	0

Test conditions: T = 22°C

InGaAs PIN Small-Area—900 nm to 1700 nm

Technical Specification

Part Number	Standard Package	Photo Sens. Diam. μm	Resp. A/W @1300 nm	Resp. A/W @1550 nm	Dark Curr. Id (nA)	Spect. Noise Curr. Dens. In (pA/ $\sqrt{\text{Hz}}$)	Cap. @100 kHz Cd (pF)	Bandwidth GHz into 50 W	NEP @ 1550 nm pW/ $\sqrt{\text{Hz}}$	Bias Volt for these Specs V
C30616ECER	Ceramic	50	0.86	0.95	0.5	<0.02	0.35	>3.5	<0.02	5
C30637ECER	Ceramic	75	0.86	0.95	0.8	<0.02	0.4	3.5	<0.02	5
C30617ECER	Ceramic	100	0.86	0.95	1	<0.02	0.55	3.5	<0.02	5
C30617B	Ball lens	100	0.8	0.9	1	<0.02	0.8	3.5	<0.02	5
C30618ECER	Ceramic	350	0.86	0.95	2	0.02	4	0.8	0.02	5
C30618G	TO window	350	0.86	0.95	2	0.02	4	0.8	0.02	5

Test conditions: T = 22°C

photodiodes

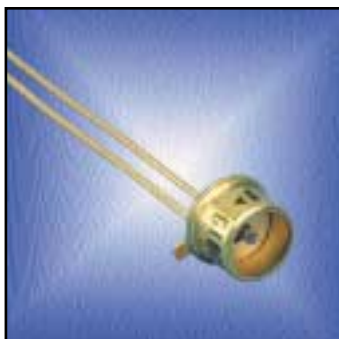

Silicon Avalanche Photodiodes

- Hermetically Sealed Packages

Si APD—Standard Types—400 nm to 1100 nm

Technical Specification

Part Number	Standard Package	Photo Sens. Diam. mm	Resp. 900 nm A/W	Dark Curr. Id (nA)	Spect. Noise Curr. Dens. In (pA/√Hz)	Cap. @100 kHz: Cd (pF)	Resp. Time tr (ns)	NEP @ 900 nm fW/√Hz	VOP Range V
C30817E	TO-5	0.8	75	50	0.5	2	2	7	275-425
C30872E	TO-8	3	45	100	0.5	10	2	11	275-425
C30902E	TO-18	0.5	77 (@ 830 nm)	15	0.23	1.6	0.05	3 (@ 830 nm)	180-250
C30902S	TO-18	0.5	128 (@ 830 nm)	15	0.11	1.6	0.05	0.86 (@ 830 nm)	180-250
C30916E	TO-5	1.5	70	100	0.5	3	2	8	275-425

Test conditions: T = 22°C

Si APD—Arrays Quadrant and Linear—400 nm to 1100 nm

Technical Specification

Part Number	Standard Package	Photo Sens. Diam. mm	Resp. @830 nm A/W	Dark Curr. Id (nA)	Spect. Noise Curr. Dens. In (pA/√Hz)	Cap. @100 kHz: Cd (pF)	Resp. Time tr (ns)	NEP @ 830 nm fW/√Hz	VOP Range V
C30927E-01	TO-8	1.5 total	62 (@900 nm)	25	0.25	1	3	16 (@900 nm)	275-425
C30927E-02	TO-8	1.5 total	62 (@900 nm)	25	0.25	1	3	16 (@900 nm)	275-425
C30927E-03	TO-8	1.5 total	62 (@900 nm)	25	0.25	1	3	16 (@900 nm)	275-425
C30985E	Custom	0.3 pitch	31	1	0.1	0.5	2	3	250-425

Test conditions: T = 22°C

Si APD—Low Cost, High Volume—400 nm to 1000 nm

Technical Specification

Part Number	Standard Package	Photo Sens. Diam. mm	Resp. @900 nm A/W	Dark Curr. Id (nA)	Spect. Noise Curr. Dens. In (pA/√Hz)	Cap. @100 kHz: Cd (pF)	Resp. Time tr (ns)	NEP @ 900 nm fW/√Hz	VOP Range V
C30724E	TO-18	0.5	9 (@ M=15)	25	0.1	1	5	11	120-200
C30724P	Plastic	0.5	9 (@ M=15)	25	0.1	1	5	11	120-200
C30737E	TO-18	0.5	47 (@ I=800 nm M=100)	20	0.3	2.5	0.3	6.4 (@ 800 nm M=100)	120-200

Test conditions: T = 22°C

Si APD—TE-Cooled

Technical Specification

Part Number	Standard Package	Photo Sens. Diam. mm	Resp. @830 nm A/W	Dark Curr. Id (nA)	Spect. Noise Curr. Dens. In (pA/√Hz)	Cap. @100 kHz: Cd (pF)	Resp. Time tr (ns)	NEP @ 830 nm fW/√Hz	ADP VOP Range V
C30902S-TC	TO-66	0.5	128	2	0.04	1.6	0.5	0.3	160-250
C30902S-DTC	TO-66	0.5	128	1	0.02	1.6	0.5	0.16	160-250

Test conditions: T = 0°C for -TC and -20°C for -DTC

ADP VOP Range: temperature dependent



Silicon Avalanche Photodiodes

- Low Cost, High Volume

Si APD—NIR-Enhanced—400 nm to 1100 nm

Technical Specification

Part Number	Standard Package	Photo Sens. Diam. mm	Resp. @1060 nm A/W	Dark Curr. Id (nA)	Spect. Noise Curr. Dens. In (pA/√Hz)	Cap. @100 kHz Cd (pF)	Resp. Time tr (ns)	NEP @ 900 nm m=15 fW/√Hz	VOP Range V
C30954E	TO-5	0.8	36	50	0.5	2	2	14	275-425
C30955E	TO-5	1.5	34	100	0.5	3	2	15	275-425
C30956E	TO-8	3	25	100	0.5	10	2	20	275-425

Test conditions: T = 22°C

Si APD—Lightpipe

Technical Specification

Part Number	Standard Package	Photo Sens. Diam. mm	Resp. @830 nm A/W	Dark Curr. Id (nA)	Spect. Noise Curr. Dens. In (pA/√Hz)	Cap. @100 kHz Cd (pF)	Resp. Time tr (ns)	NEP @ 830 nm fW/√Hz	VOP Range V
C30921E	TO-18	0.5	77	15	0.23	1.6	0.05	3	180-250
C30921S	TO-18	0.5	128	15	0.11	1.6	0.05	0.86	180-250

Test conditions: T = 22°C

Si APD—Radiation Detection

Technical Specification

Part Number	Photo Sens. Diam. mm	Resp. A/W	Dark Curr. Id (nA)	Spect. Noise Curr. Dens. In (pA/√Hz)	Cap. @100 kHz Cd (pF)	Resp. Time tr (ns)	NEP @ Peak fW/√Hz	VOP Range V
C30626	5x5	22 (@900 nm)	250	0.5	30	5	23 (@900 nm)	275-425
C30703	10x10	16 (@530 nm)	10	0.7	120	5	40 (@530 nm)	275-425

Test conditions: T = 22°C

photodiodes



Silicon PIN Photodiodes and Modules

- Broad Range of Photosensitive Areas
- Low Operating Voltage
- Hermetically Sealed Packages

Si PINs—Window and Lightpipe Packages, Fast Response—400 nm to 1100 nm

Technical Specification

Part Number	Standard Package	Photo Sens. Diam. mm	Resp. @830 nm A/W	Dark Curr. Id nA	Spect. Noise Curr. Dens. In (fA/√Hz)	Cap. @100 kHz Cd (pF)	Resp. Time tr (ns)	NEP @ 830 nm fW/√Hz	Bias Volt for These Specs V
C30971E	TO-18	0.5	0.5	10	57	1.6	0.5	113	100
C30971EL	TO-18 Lightpipe	0.25	0.5	10	57	1.6	0.5	113	100

Test conditions: T = 22°C

Si PINs—Large Area, Fast Response—400 nm to 1100 nm

Technical Specification

Part Number	Standard Package	Photo Sens. Diam. mm	Resp. @900 nm A/W	Dark Curr. Id nA	Spect. Noise Curr. Dens. In (fA/√Hz)	Cap. @100 kHz Cd (pF)	Resp. Time tr (ns)	NEP @ 900 nm fW/√Hz	Bias Volt for These Specs V
FFD-100	TO-5	2.5	0.58	2	25	8.5	3.5	44	15
FFD-200	TO-8	5.1	0.58	4	36	30	5	62	15

Test conditions: T = 22°C

Si PINs—Quadrant—220 nm to 1100 nm

Technical Specification

Part Number	Standard Package	Photo Sens. Diam. total mm	Resp. @900 nm A/W	Dark Curr. Id nA	Spect. Noise Curr. Dens. In (fA/√Hz)	Cap. @100 kHz Cd (pF)	Resp. Time tr (ns)	NEP @ 900 nm fW/√Hz	Bias Volt for These Specs V
C30845E	TO-5	8	0.6	7	47	8	6	79	45
UV-140BQ-4	TO-5	1.3x1.3 (x4)	0.58	—	4	34	<1 μsec	7	0
YAG-444-4A	Custom	11.4	0.4 @1.06 μm	40	118	9	25	295	180

Test conditions: T = 22°C

Si PINs—Standard N-Type—400 nm to 1100 nm

Technical Specification

Part Number	Standard Package	Photo Sens. Diam. mm	Resp. @900 nm A/W	Dark Curr. Id nA	Spect. Noise Curr. Dens. In (fA/√Hz)	Cap. @100 kHz Cd (pF)	Resp. Time tr (ns)	NEP @ 900 nm fW/√Hz	Bias Volt for These Specs V
C30807E	TO-18	1	0.6	1	18	2.5	3	30	45
C30808E	TO-5	2.5	0.6	3	31	6	5	52	45
C30822E	TO-8	5	0.6	5	40	17	7	67	45
C30809E	TO-8	8	0.6	7	47	35	10	79	45
C30810E	Custom	11.4	0.6	30	98	70	12	163	45

Test conditions: T = 22°C



Silicon PINs—UV Enhanced

Si PINs—UV Enhanced, Low Noise—220 nm to 1100 nm

Technical Specification

Part Number	Standard Package	Photo Sens. Diam. mm	Resp. A/W		Shunt Resis. Rd MW	Spect. Noise Curr. Dens.: In (fW/√Hz)	Cap. @100 kHz: Cd (pF)	NEP @ 900 nm fA/√Hz
			@250 nm	@900 nm				
UV-040BQ	TO-8	1	0.12	0.58	2000	3	25	5
UV-100BQ	TO-8	2.5	0.12	0.58	1000	4	120	7
UV-215BQ	TO-8	5.4	0.12	0.58	250	8	450	25
UV-245BQ	TO-8	4.4x4.7	0.12	0.58	375	7	375	20
UV-140BQ-2	TO-5	2.5x1.3 (x2)	0.12	0.58	1000	4	68	7
UV-140BQ-4	TO-5	1.3x1.3 (x4)	0.12	0.58	1000	4	34	7

Test conditions: T = 22°C

Si PIN Modules—Low Bandwidth—1 kHz to 50 kHz

Technical Specification

Part Number	Standard Package	Photo Sens. Diam. mm	Resp. MV/W		Spect. Noise Volt. Dens. Vn (μV/√Hz)	NEP @ 900 nm pW/√Hz	Bandwidth kHz into 50 W	Bias Volt for These Specs V
			@250 nm	@900 nm				
HUV-2000B	Custom	5.4	24	116	2.5	0.02	2	0
HUV-1100BG	TO-5	2.5	24	116	20	0.17	20	0

Test conditions: T = 22°C

Si PIN Modules—High Bandwidth—40 MHz to 100 MHz

Technical Specification

Part Number	PIN or APD Used	Standard Package	Photo Sens. Diam. mm	Resp. kV/W @900 nm	Lin. Volt. Out Swing (V)	Spect. Noise Volt. Dens. Vn (nV/√Hz)	NEP @900 nm pW/√Hz	Bandwidth MHz (3 dB, into 50 W)	Photo. Diode Bias Volt V
C30608E	C30971	TO-5	0.5	32 (@ 830 nm)	0.7	60	1.8 (@ 830 nm)	50	12
C30659-1550-R2A	C30662	TO-8	0.2	340 (@ 1550 nm)	2	35	0.103 (@ 1550 nm)	50	40-90
C30950E	C30817	TO-8	0.8	560	0.7	20	.036	50	275-425
C30919E	C30817	Custom	0.8	1000	0.7	25	.025	40	275-425

Test conditions: T = 22°C

photodiodes

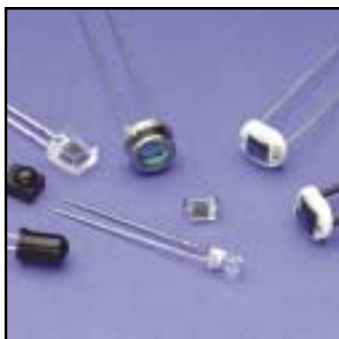

Silicon PN Photodiodes

Table Key

I_{SC}	Short-Circuit Current H=100 fc, 2850 K
$TC I_{SC}$	I_{SC} Temperature Coefficient, 2850 K
V_{OC}	Open-Circuit Voltage H=100 fc, 2850 K
$TC V_{OC}$	V_{OC} Temperature Coefficient, 2850 K
I_D	Dark Current H=0, $V_R=10, 50, 100$ V
R_{SH}	Shunt Resistance H=0, $V=10$ mV
C_J	Junction Capacitance H=0, $V=0, 3, 15$ V
R_E	Responsivity 880-940 nm
S_R	Sensitivity @ Peak
λ_{range}	Spectral Application Range
λ_p	Spectral Response @ Peak
V_{BR}	Breakdown Voltage

Table Key

I_{SC}	Short-Circuit Current H=1000 lux, 2850 K
$TC I_{SC}$	I_{SC} Temperature Coefficient H=1000 lux, 2850 K
I_D	Dark Current H=0, $V_R=100$ mV
$TC I_D$	I_D Temperature Coefficient H=0, $V_R=100$ mV
R_{SH}	Shunt Resistance H=0, $V_R=10$ mV
C_J	Junction Capacitance H=0, $V=0$ V, 1 MHz
S_R	Sensitivity @ 400 nm
R_E	Responsivity 400 nm, 0.18 A/W
t_R/t_F	Rise/Fall Time @ 1 K Ω load $V_R=1$ V, 830 nm
V_{OC}	Open-Circuit Voltage H=1000 lux, 2850 K
$TC V_{OC}$	V_{OC} Temperature Coefficient H=1000 lux, 2850 K

Silicon PN—VTP Series

Technical Specification

Part Number	I_{SC} μA	$TC I_{SC}$ %/C	V_{OC} mV	$TC V_{OC}$ mV/C	I_D nA max.	R_{SH} G Ω	C_J pF	R_E A/(W/cm ²)	S_R A/W	λ_{range} nm	λ_p nm	V_{BR} V
VTP100	55	0.24	300	-2	30	0.25	50 max.	0.047	0.5	725-1150	925	140
VTP100C	70	0.2	350	-2	30	0.25	50 max.	0.05	0.55	400-1150	925	140
VTP1012	17	0.2	350	-2	7	0.5	6 max.	0.011	0.55	400-1150	925	140
VTP1112	90	0.2	350	-2	7	0.5	6 max.	0.033	0.55	400-1150	925	140
VTP1188S	200	0.2	0.33	-2	30	67	0.18	—	0.55	400-1100	925	—
VTP1232	100 min.	0.2	0.42 min.	-2	25	—	0.18	0.076	0.6	400-1100	920	—
VTP3310LA	36	0.2	350	-2	35	10	25 max.	0.015	0.55	400-1150	925	140
VTP3410LA	22	0.26	350	-2	35	10	25 max.	0.013	0.55	700-1150	925	140
VTP4085	200	0.2	0.33	-2	100	2	0.35	—	0.55	400-1100	925	—
VTP4085S	200	0.2	0.33	-2	50	4	0.35	—	0.55	400-1100	925	—
VTP5050	70	0.2	350	-2	18	0.25	24 max.	0.05	0.55	400-1150	925	140
VTP6060	200	0.2	350	-2	35	100	60 max.	0.14	0.55	400-1150	925	140
VTP7110	9	0.2	350	-2	35	7	25 max.	0.015	0.55	400-1150	925	140
VTP7210	7	0.26	350	-2	35	7	25 max.	0.015	0.55	700-1150	925	140
VTP7840	70	0.2	325	-2	20	0.25	40 max.	—	0.55	725-1150	925 1@10 mA	—
VTP8350	80	0.2	350	-2	30	100	50 max.	0.06	0.55	400-1150	925	140
VTP8440	55	0.2	350	-2	15	0.5	15 max.	0.025	0.55	400-1150	925	140
VTP8551	70	0.2	350	-2	30	0.15	50 max.	0.05	0.55	400-1150	925	140
VTP8651	55	0.24	300	-2	30	0.15	50 max.	0.045	0.5	725-1150	925	140
VTP9412	17	0.2	350	-2	7	0.4	6 max.	0.011	0.55	400-1150	925	140

Electro-optical characteristics @ 25°C

Silicon PN—VTS Series

Technical Specification

Part Number	I_{SC} mA	$TC I_{SC}$ %/C	I_D μA	$TC I_D$ %/C	R_{SH} M Ω	C_J nF	S_R A/W	R_E A/(W/cm ²)	t_R/t_F μsec	V_{OC} V	$TC V_{OC}$ mV/C
VTS_80	3	0.2	0.2	+11	0.3	7.5	0.2	0.7	13	0.45	-2.6
VTS_81	1.5	0.2	100	+11	0.6	3.5	0.2	0.34	6.4	0.45	-2.6
VTS_82	0.69	0.2	0.05	+11	1.2	1.75	0.2	0.16	3.4	0.45	-2.6
VTS_83	0.64	0.2	50	+11	1.2	1.75	0.2	0.15	3.4	0.45	-2.6
VTS_84	0.33	0.2	40	+11	1.5	1	0.2	0.07	1.8	0.45	-2.6
VTS_85	0.16	0.2	0.02	+11	3	0.5	0.2	0.04	1.2	0.45	-2.6
VTS_86	0.080	0.2	10	+11	6	0.25	0.2	0.02	0.75	0.45	-2.6

Electro-optical characteristics @ 25°C

Table Key

I_{SC}	Short-Circuit Current 940 nm, H=0.5 mW/cm ² (VTD205, VTD206) H=5 mW/cm ² , 2850 K (VTD31AA, VTB Series) 100 Lux, 2850 K (VTD34, VTD205K) 100 Lux, 2856 K (VTD206K)
TC I_{SC}	I_{SC} Temperature Coefficient 2850 K (VTD31AA, VTD34, VTD34F, VTB Series) 2856 K (VTD205, VTD205K, VTD206, VTD206K)
V_{OC}	Open-Circuit Voltage 940 nm, H=0.5 mW/cm ² (VTD 205, VTD205K, VTD206, VTD206K) 2850 K (VTD31AA, VTD34, VTD34F)
TC V_{OC}	V_{OC} Temperature Coefficient 2850 K (VTD31AA, VTD34, VTD34F, VTB Series) 2856 K (VTD205, VTD205K, VTD206, VTD206K)
I_D	Dark Current H=0, $V_R=2$ V (VTB Series) H=0, $V_R=10$ V (VTD34, VTD34F, VTD205, VTD205K, VTD206, VTD206K, VTB100) H=0, $V_R=15$ V (VTD31AA)
R_{SH}	Shunt Resistance H=0, $V=10$ mV (VTB Series)
TC R_{SH}	R_{SH} Temperature Coefficient H=0, $V=10$ mV (VTB Series)
C_J	Junction Capacitance H=0, $V_R=0$ V, 1 MHz (VTD205, VTD205K, VTD206, VTD206K) @ 1 MHz, $V_R=0$ V (VTD34, VTD34F)
t_R/t_F	Rise/Fall Time H=0, $V=0$ V (VTD31AA, VTB Series) @ $R_L=50 \Omega$, $V_R=5$ V, 850 nm (VTD205, VTD205K, VTD206, VTD206K) @ $R_L=1$ k Ω Lead, $V_R=10$ V, 833 nm (VTD34, VTD34F)
S_R	Sensitivity @ Peak 365 nm (VTB Series)
λ_{range}	Spectral Application Range
λ_p	Spectral Response @ Peak
V_{BR}	Breakdown Voltage

Silicon PN—VTD Series

Technical Specification

Part Number	I_{SC} μ A	TC I_{SC} %/°C	V_{OC} mV	TC V_{OC} mV/°C	I_D nA max.	C_J pF	t_R/t_F nsec	S_R A/W	λ_{range} nm	λ_p nm	V_{BR} V
VTD31AA	150-225	0.2	350	-2	50	500 max.	—	0.55	400-1150	860	5 min.
VTD34	70	0.2	365	-2	30	60	50	0.6	400-1100	900	40 min.
VTD34F	—	—	350	-2	30	60	50	0.6	725-1150	940	40 min.
VTD205	25	0.2	350	-2.6	30.	72	20	0.6	800-1100	925	50
VTD205K	80	0.2	365	-2.6	30	72	20	0.6	400-1100	925	50
VTD206	25	0.2	350	-2.6	30	72	20	0.6	750-1100	925	50
VTD206K	80	0.2	365	-2.6	30	72	20	0.6	400-1100	925	50

Electro-optical characteristics @ 25°C

Silicon PN—VTB Series

Technical Specification

Part Number	I_{SC} μ A	TC I_{SC} %/°C	V_{OC} mV	TC V_{OC} mV/°C	I_D pA max.	R_{SH} G Ω	TC R_{SH} %/°C	C_J nF	S_R A/W	λ_{range} nm	λ_p nm	V_{BR} V
VTB100	65	0.12	490	-2	500	1.4	-8	2 max.	0.1	320-1100	920	40
VTB1012	13	0.12	490	-2	100	0.25	-8	0.31	0.09	320-1100	920	40
VTB1012B	1.3	0.02	420	-2	100	0.25	-8	0.31	—	330-720	580	40
VTB1013	13	0.12	490	-2	20	7	-8	0.31	0.09	320-1100	920	40
VTB1013B	1.3	0.02	420	-2	20	7	-8	0.31	—	330-720	580	40
VTB1112	60	0.12	490	-2	100	0.25	-8	0.31	0.19	320-1100	920	40
VTB1112B	6	0.02	420	-2	100	0.25	-8	0.31	—	330-720	580	40
VTB1113	60	0.12	490	-2	20	7	-8	0.31	0.19	320-1100	920	40
VTB1113B	6	0.02	420	-2	20	7	-8	0.31	—	330-720	580	40
VTB4051	200	0.12	490	-2	250	0.56	-8	3	0.1	320-1100	920	40
VTB5051	130	0.12	490	-2	250	0.56	-8	3	0.1	320-1100	920	40
VTB5051B	13	0.02	420	-2	250	0.56	-8	3	—	330-720	580	40
VTB5051J	130	0.12	490	-2	250	0.56	-8	3	0.1	320-1100	920	40
VTB5051UV	130	0.12	490	-2	250	0.56	-8	3	0.1	200-1100	920	40
VTB5051UVJ	130	0.12	490	-2	250	0.56	-8	3	0.1	200-1100	920	40
VTB6061	350	0.12	490	-2	2	0.1	-8	8	0.1	320-1100	920	40
VTB6061B	35	0.02	420	-2	2	0.1	-8	8	—	330-720	580	40
VTB6061CIE	—	—	—	—	2	0.1	-8	8	—	—	555	—
VTB6061J	350	0.12	490	-2	2	0.1	-8	8	0.1	320-1100	920	40
VTB6061UV	350	0.12	490	-2	2	0.1	-8	8	0.1	200-1100	920	40
VTB6061UVJ	350	0.12	490	-2	2	0.1	-8	8	0.1	200-1100	920	40
VTB8341	60	0.12	490	-2	100	1.4	-8	1	0.1	320-1100	920	40
VTB8440	45	0.12	490	-2	2000	0.07	-8	1	0.1	320-1100	920	40
VTB8440B	5	0.02	420	-2	2000	0.07	-8	1	—	330-720	580	40
VTB8441	45	0.12	490	-2	100	1.4	-8	1	0.1	320-1100	920	40
VTB8441B	5	0.02	420	-2	100	1.4	-8	1	—	330-720	580	40
VTB9412	13	0.12	490	-2	100	0.25	-8	0.31	0.09	320-1100	920	40
VTB9412B	1.3	0.02	420	-2	100	0.25	-8	0.31	—	330-720	580	40
VTB9413	13	0.12	490	-2	20	7	-8	0.31	0.09	320-1100	920	40
VTB9413B	1.3	0.02	420	-2	20	7	-8	0.31	—	330-720	580	40

photocells



Features

- Lowest-cost visible detector
- Available in low-cost plastic-encapsulated packages as well as hermetic packages (TO-46, TO-5, TO-8)
- Responsive to both very low light levels (moonlight) and to very high light levels (direct sunlight)
- Wide dynamic range: resistance changes of several orders of magnitude between "light" and "no light"
- Low noise distortion
- Maximum operating voltages of 50 to 400 volts are suitable for operation on 120/240 VAC
- Available in center-tap dual-cell configurations as well as specially selected resistance ranges for special applications
- Easy to use in DC or AC circuits
- Usable with almost any visible or near-infrared light source such as LEDs; neon; fluorescent, incandescent bulbs, lasers; flame sources; sunlight; etc.
- Available in a wide range of resistance values



Typical Analog Applications

- Camera Exposure Control
- Auto-Focus for Slide Projector
- Colorimetric Test Equipment
- Densitometer
- Electronic Scales—dual-cell
- Automated Rear-View Mirror



Typical Digital Applications

- Automatic Headlight Dimmer
- Night Light Control
- Oil Burner Flame Out
- Street Light Control
- Absence/Presence (beam breaker)
- Position Sensor

Datasheets available upon request

Description

Photocells or Light-Dependent Resistors can provide a very economical and technically superior solution for many applications where the presence or absence of light is sensed (digital operation) or where the intensity of light needs to be measured (analog operation).

Semiconductor light detectors can be divided into two major categories: junction and bulk-effect devices. Junction devices, when operated in the photoconductive mode, utilize the reverse characteristic of a PN junction. Under reverse bias, the PN junction acts as a light-controlled current source. Output is proportional to incident illumination and is relatively independent of applied voltage. Silicon photodiodes are examples of this type of detector.

In contrast, bulk-effect photoconductors have no junction. The bulk resistivity decreases with increasing illumination, allowing more photocurrent to flow. This resistive characteristic gives bulk-effect photoconductors a unique quality: signal current from the detector can be varied over a wide range by adjusting the applied voltage. To clearly make this distinction, PerkinElmer Optoelectronics refers to its bulk-effect photoconductors as photoconductive cells or, simply, photocells.

Photocells are thin-film devices made by depositing a layer of a photoconductive material on a ceramic substrate. Metal contacts are evaporated over the surface of the photoconductor and external electrical connection is made to these contacts. These thin films of photoconductive material have a high sheet resistance. Therefore, the space between the two contacts is made narrow and interdigitated for low cell resistance at moderate light levels.

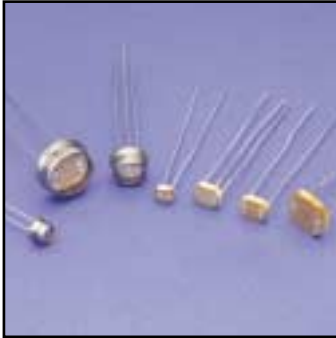

VT Series

VT Series

Technical Specification

Part Number	Resistance (Ohms)				Dark min.	Dark sec.	Material Type	Sensitivity (% typ.)		Max. Volts V, pk	Response Time @ 1fc ms, typ.	
	10 lux min.	2850 K typ.	24 k max.	2 fc 2850 K typ.				LOG (R10/R100)	LOG (100/10)		Rise (1-1/e)	Fall (1/e)
VT20N1	8 k	16 k	24 k	8 k	200 k	5	0	0.8	100	78	8	
VT20N2	16 k	34 k	52 k	17 k	500 k	5	0	0.8	100	78	8	
VT20N3	36 k	72 k	108 k	36 k	1 M	5	0	0.8	100	78	8	
VT20N4	76 k	152 k	230 k	76 k	2 M	5	0	0.8	200	78	8	
VT23N1	20 k	40 k	60 k	20 k	500 k	5	3	0.85	100	35	5	
VT23N2	42 k	86 k	130 k	43 k	1 M	5	3	0.85	100	35	5	
VT23N3	90 k	180 k	270 k	90 k	2 M	5	3	0.85	100	35	5	
VT30N1	6 k	12 k	18 k	6 k	200 k	5	0	0.75	100	78	8	
VT30N2	12 k	24 k	36 k	12 k	500 k	5	0	0.8	200	78	8	
VT30N3	24 k	48 k	72 k	24 k	1 M	5	0	0.8	200	78	8	
VT30N4	50 k	100 k	150 k	50 k	2 M	5	0	0.8	300	78	8	
VT33N1	20 k	40 k	60 k	20 k	500 k	5	3	0.9	100	35	5	
VT33N2	40 k	80 k	120 k	40 k	1 M	5	3	0.9	200	35	5	
VT33N3	80 k	160 k	240 k	80 k	2 M	5	3	0.9	200	35	5	
VT30CT	10 k	20 k	30 k	10 k	500 k	5	0	0.8	200	78	8	
VT33CT	60 k	120 k	180 k	60 k	1 M	5	3	0.9	200	35	5	
VT50N1	4 k	8 k	12 k	4 k	200 k	5	0	0.75	200	78	8	
VT50N2	8 k	16 k	24 k	8 k	500 k	5	0	0.75	200	78	8	
VT50N3	16 k	32 k	48 k	16 k	1 M	5	0	0.8	300	78	8	
VT53N1	16 k	32 k	48 k	16 k	1 M	5	3	0.85	200	35	5	
VT53N2	32 k	76 k	96 k	38 k	2 M	5	3	0.85	200	35	5	
VT53N3	66 k	132 k	200 k	66 k	3 M	5	3	0.85	300	35	5	
VT80N1	4 k	8 k	12 k	4 k	100 k	5	0	0.8	100	78	8	
VT80N2	8 k	16 k	24 k	8 k	500 k	5	0	0.8	200	78	8	
VT83N1	6 k	12 k	18 k	6 k	100 k	5	3	0.95	100	35	5	
VT83N2	12 k	28 k	36 k	14 k	500 k	5	3	0.95	200	35	5	
VT83N3	24 k	48 k	72 k	24k	1 M	5	3	0.95	200	35	5	
VT83N4	50 k	100 k	150 k	50 k	2 M	5	3	0.95	200	35	5	
VT83CT	30 k	60 k	90 k	30 k	1 M	5	3	0.90	100	35	5	
VT90N1	6 k	12 k	18 k	6 k	200 k	5	0	0.8	100	78	8	
VT90N2	12 k	24 k	36 k	12 k	500 k	5	0	0.8	100	78	8	
VT90N3	25 k	50 k	75 k	25 k	1 M	5	0	0.85	100	78	8	
VT90N4	50 k	100 k	150 k	50 k	2 M	5	0	0.9	100	78	8	
VT93N1	12 k	24 k	36 k	12 k	300 k	5	3	0.9	100	35	5	
VT93N2	24 k	48 k	72 k	24 k	500 k	5	3	0.9	100	35	5	
VT93N3	50 k	100 k	150 k	50 k	500 k	5	3	0.9	100	35	5	
VT93N4	100 k	200 k	300 k	100 k	500 k	5	3	0.9	100	35	5	
VT935G-A	10 k	18.5 k	27 k	9.3 k	1 M	5	3	0.9	100	35	5	
VT935G-B	20 k	29 k	38 k	15 k	1 M	5	3	0.9	100	35	5	
VT935G-C	31 k	40.5 k	50 k	20 k	1 M	5	3	0.9	100	35	5	

Specification Notes

Photocells categorized into groups by resistance. All groups must be purchased together and PerkinElmer maintains the right to determine the product mix among these groups.

Dimensions controlled at base of package.

Photocells are tested at either 1 fc or 10 lux. 2 fc. typical values shown in the tables are for reference only.

Cells are light-adapted at 30–50 fc.

The photocell “grid” pattern can vary from that shown. PerkinElmer reserves the right to change mix grid patterns on any standard product.

The resistance for any standard cell is controlled at only one light level. If the resistance at other light levels is a concern, please contact the factory.

photocells

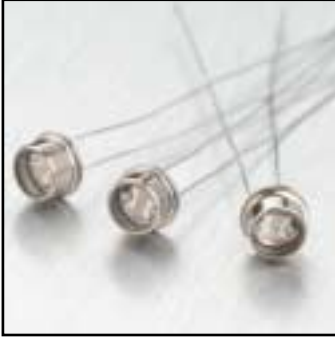

A10 Series



B90 Series

Table Key

- R 10 Resistance at E=10 lux light intensity
- R 100 Resistance at E=100 lux light intensity
- R01 Dark Resistance after 1 sec (E=0)
- R05 Dark Resistance after 5 sec (E=0)
- $\gamma_{10/100}$ Sensitivity $\log(R10/R100)/\log(100 \text{ lux}/10 \text{ lux})$
- λ_{peak} Peak Spectral Sensitivity
- T_{op} Operating Temperature
- T_{st} Storage Temperature
- TC Thermal Coefficient
- t_{on} Rise Time to 63% of final I (R10)
- t_{off} Decay Time to 37% of initial I (R10)
- V_{max} Maximum Operating Voltage at E=0 lux
- P_{max} Power Dissipation at 25°C Ambient Temperature

VT43 Series

Technical Specification

Part Number	Resistance (Ω)					Dark min.	Dark sec.	Material Type	Sensitivity (γ , typ.)		Max. Volts V, pk	Response Time @ fc ms, typ.	
	1 fc 6500 K min.	8 k typ.	12 k max.	2 fc 2850 K typ.	—				LOG (R10/R100)	LOG (100/10)		Rise (1-1/e)	Fall (1/e)
VT43N1	4 k	8 k	12 k	—	300 k	30	3	0.9	250	90	18		
VT43N2	8 k	16 k	24 k	—	300 k	30	3	0.9	250	90	18		
VT43N3	16 k	32 k	48 k	—	500 k	30	3	0.9	400	90	18		
VT43N4	33 k	66 k	100 k	—	500 k	30	3	0.9	400	90	18		

A10 Series

Technical Specification

Part Number	Typical Electro-Optical Characteristics						λ_{peak} nm	Top range °C	Tst range °C	Limit Values				
	R10 range k Ω	R100 typ. k Ω	R01 min. M Ω	R05 min. M Ω	$\gamma_{10/100}$ typ.	TC 10 lux %/k				t_{on} typ. msec	t_{off} typ. msec	V_{max} V	P_{max} mW	
A106009	4-11	2	0.04	0.12	0.65	600	-20+70	-20+80	0.4	50	40	100	90	
A106011	9-20	3.5	0.06	0.18	0.65	600	-20+70	-20+80	0.3	60	40	150	90	
A106012	16-33	5	0.18	0.5	0.7	600	-20+70	-20+80	0.35	50	35	150	90	
A106013	27-94	8	0.5	1.5	0.8	600	-20+70	-20+80	0.4	35	30	150	90	
A106014	77-340	15	1.5	5	0.9	600	-20+70	-20+80	0.5	25	20	150	90	
A106031	60-130	23	0.4	1.2	0.65	600	-20+70	-20+80	0.3	60	40	300	90	
A106032	120-210	35	1	3	0.7	600	-20+70	-20+80	0.35	50	35	300	90	
A106033	200-580	50	3	9	0.8	600	-20+70	-20+80	0.4	35	30	300	90	
A106034	500-1200	100	5	15	0.9	600	-20+70	-20+80	0.5	25	20	300	90	
A105009	4-11	2	0.04	0.12	0.65	530	-20+70	-20+80	0.3	70	50	100	90	
A105011	9-22	4	0.05	0.15	0.6	530	-20+70	-20+80	0.2	70	50	150	90	
A105012	18-44	7	0.15	0.45	0.65	530	-20+70	-20+80	0.2	60	40	150	90	
A105013	36-88	12	0.4	1.2	0.7	530	-20+70	-20+80	0.3	50	30	150	90	
A105014	70-200	20	1	3	0.75	530	-20+70	-20+80	0.3	40	30	150	90	

All readings taken at standard light A (2854 K color temperature) after 2 hours of preillumination at 500 lux

A90 Series

Technical Specification

Part Number	Typical Electro-Optical Characteristics						λ_{peak} nm	Top range °C	Tst range °C	Limit Values				
	R10 range k Ω	R100 typ. k Ω	R01 min. M Ω	R05 min. M Ω	$\gamma_{10/100}$ typ.	TC 10 lux %/k				t_{on} typ. msec	t_{off} typ. msec	V_{max} V	P_{max} mW	
A906009	4-11	2	0.04	0.12	0.65	600	-20+70	-20+80	0.4	50	40	100	90	
A906011	9-20	3.5	0.06	0.18	0.65	600	-20+70	-20+80	0.3	60	40	150	90	
A906012	16-33	5	0.18	0.5	0.7	600	-20+70	-20+80	0.35	50	35	150	90	
A906013	27-94	8	0.5	1.5	0.8	600	-20+70	-20+80	0.4	35	30	150	90	
A906014	77-340	15	1.5	5	0.9	600	-20+70	-20+80	0.5	25	20	150	90	
A906031	60-130	23	0.4	1.2	0.65	600	-20+70	-20+80	0.3	60	40	300	90	
A906032	120-210	35	1	3	0.7	600	-20+70	-20+80	0.35	50	35	300	90	
A906033	200-580	50	3	9	0.8	600	-20+70	-20+80	0.4	35	30	300	90	
A906034	500-1200	100	5	15	0.9	600	-20+70	-20+80	0.5	25	20	300	90	
A905012	18-44	7	0.15	0.45	0.65	530	-20+70	-20+80	0.2	60	40	150	90	
A905013	36-88	12	0.4	1.2	0.7	530	-20+70	-20+80	0.3	50	30	150	90	
A905014	70-200	20	1	3	0.75	530	-20+70	-20+80	0.3	40	30	150	90	
A995009	4-11	2	0.04	0.12	0.65	530	-20+70	-20+80	0.3	70	50	100	90	
A995011	9-22	4	0.05	0.15	0.6	530	-20+70	-20+80	0.2	70	50	150	90	
A995012	18-44	7	0.15	0.45	0.65	530	-20+70	-20+80	0.2	60	40	150	90	
A995013	36-88	12	0.4	1.2	0.7	530	-20+70	-20+80	0.3	50	30	150	90	
A995014	70-200	20	1	3	0.75	530	-20+70	-20+80	0.3	40	30	150	90	

All readings taken at standard light A (2854 K color temperature) after 2 hours of preillumination at 500 lux

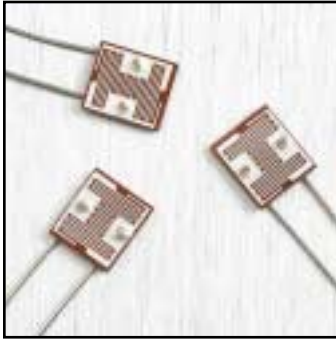

B Series

Technical Specification

Part Number	Typical Electro-Optical Characteristics						Limit Values						
	R10 range kΩ	R100 typ. kΩ	R01 min. MΩ	R05 min. MΩ	$\gamma_{10/100}$ typ.	λ_{peak} nm	Top range °C	Tst range °C	TC 10 lux %/K	ton typ. msec	toff typ. msec	Vmax. V	Pmax. mW
B906023	4-15	1.6	0.1	0.3	0.8	600	-20+70	-20+80	0.4	35	30	300	200
B906032	5-13	2	0.1	0.3	0.7	600	-20+70	-20+80	0.3	50	35	300	200
B906033	11-40	5	0.2	0.6	0.8	600	-20+70	-20+80	0.4	35	25	300	200

All readings taken at standard light A (2854 K color temperature) after 2 hours of preillumination at 500 lux

D Series

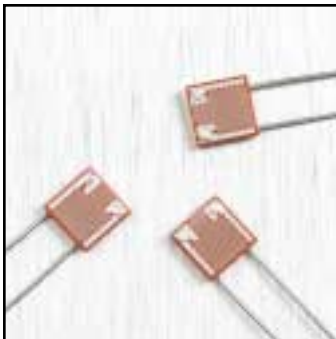

D Series

Technical Specification

Part Number	Typical Electro-Optical Characteristics						Limit Values						
	R10 range kΩ	R100 typ. kΩ	R01 min. MΩ	R05 min. MΩ	$\gamma_{10/100}$ typ.	λ_{peak} nm	Top range °C	Tst range °C	TC 10 lux %/K	ton typ. msec	toff typ. msec	Vmax. V	Pmax. mW
D996011	1.5-3	0.6	0.01	0.03	0.6	600	-20+70	-20+80	0.3	60	35	150	200
D996012	2.8-6	0.8	0.03	0.09	0.7	600	-20+70	-20+80	0.35	50	30	150	200
D996013	4.5-13	1.5	0.1	0.3	0.8	600	-20+70	-20+80	0.4	35	25	150	200
D996021	4-9	1.8	0.03	0.09	0.6	600	-20+70	-20+80	0.3	60	35	150	200
D996022	8-15	2.5	0.09	0.27	0.7	600	-20+70	-20+80	0.35	50	30	150	200
D996023	12-35	4	0.5	1.5	0.8	600	-20+70	-20+80	0.4	35	25	150	200

All readings taken at standard light A (2854 K color temperature) after 2 hours of preillumination at 500 lux

M Series



M Series

Technical Specification

Part Number	Typical Electro-Optical Characteristics						Limit Values						
	R10 range kΩ	R100 typ. kΩ	R01 min. MΩ	R05 min. MΩ	$\gamma_{10/100}$ typ.	λ_{peak} nm	Top range °C	Tst range °C	TC 10 lux %/K	ton typ. msec	toff typ. msec	Vmax. V	Pmax. mW
M996011a	1.5-5	0.7	0.05	0.15	0.7	600	-20+70	-20+80	0.3	50	30	100	200
M996011b	0.8-2	0.4	0.05	0.15	0.65	600	-20+70	-20+80	0.3	40	30	100	200

All readings taken at standard light A (2854 K color temperature) after 2 hours of preillumination at 500 lux

U Series

U Series

Technical Specification

Part Number	Typical Electro-Optical Characteristics						Limit Values						
	R10 kΩ	R100 typ. kΩ	R01 min. mΩ	R05 min. mΩ	$\gamma_{10/10}$ min.	λ_{peak} nm	top range °C	tst range °C	TC 10 lux %/K	ton typ. msec	toff typ. msec	Vmax V	Pmax mW
U116012	20-50	8	0.12	0.36	0.7	550	-20+70	-20+80	0.3	50	40	150	50
U116013	35-220	15	0.4	1.2	0.85	550	-20+70	-20+80	0.35	40	30	150	50
U116014	150-1000	35	1	3	0.95	550	-20+70	-20+80	0.4	30	25	150	50
U116032	100-320	40	1	3	0.7	550	-20+70	-20+80	0.3	40	30	400	50
U116033	250-1100	75	2	6	0.85	550	-20+70	-20+80	0.35	30	25	400	50

All readings taken at standard light A (2854 K color temperature) after 2 hours of preillumination at 500 lux

ultraviolet detectors



Features

- High sensitivity
- Low temperature dependence
- Available in TO-5, TO-18 and miniature housing
- Various selective filter window options
- Radiation resistant types
- Built-in lens types
- Built-in amplifier types
- Long-term stability at high radiation intensity
- High temperature resistivity



Typical Applications

- Solar Measurement
- Sterilization
- Burner Controls
- Industrial Controls

Datasheets available upon request

Description

PerkinElmer Optoelectronics offers a range of selective sensors for ultraviolet radiation. This sensor series can be equipped with an integrated amplifier and is perfectly suited for the detection of any radiation ranging from 200 nm to 400 nm. High sensitivity, hermetic encapsulation, small dimension (TO-5) and low cost structure provide suitability for both industrial and consumer applications.

UV Detector Basics

UV detectors from PerkinElmer Optoelectronics are based on silicon-carbide, a material that offers new performance features at reasonable cost. Silicon-carbide provides a unique sensitivity in the spectral range from 200 to 400 nm (peak at 280 nm).

Standard UV Detectors

PerkinElmer Optoelectronics' range of standard ultraviolet detectors comprises different housings and window options. Detectors of this 'S' type contain the UV-sensitive photodiode only, and the signal output represents an intensity-dependent photodiode current.

As a default, the standard window (>210 nm) will be applied. Other windows with more selective wavelengths are A1, A2, A0, C1.

Standard UV Detectors With Built-in Lens

Products can be supplied with a standard window or built-in lens.

Amplified Output Types

Sensors of this 'T' type consist of an additional transimpedance amplifier of certain amplification, and the sensor output represents an intensity-dependent voltage.

E'xx' corresponds to the power of ten of the amplification factor ranging between 10^7 (E07) and 10^{10} (E10). Optional versions are available on request only.

Different housings and window options are available. As a default, the standard window will be applied. Other windows with more selective wavelengths are A1, A2, A0, C1.

Amplified Output Types With Built-in Lens

Products can be supplied with a standard window or built-in lens.



Ultraviolet Detectors

General Data

Max. Operating Temperature:
-20 to +80°C
Max. Storage Temperature:
-20 to +80°C
Spectral Response: 210-380 nm

Standard UV Detectors

Technical Specification

Part Number	Housing	Radiant Sensitivity mA/W	Pk. Response Wavelength nm	Sensitive Area mm ²	Selectivity	Dark Current fA	Junction Capacitance pF	Temperature Coefficient %/K
UV10SF	TO-5	140	280	5.4x10 ⁻²	>10 ⁻⁵	0.2	21	-0.5
UV10SL	TO-5	25	280	12.5	>10 ⁻⁵	0.2	21	-0.5
UV20SF	TO-18	140	280	5.4x10 ⁻²	<10 ⁻⁵	0.2	21	-0.5
UV21SF*	TO-18	140	280	5.4x10 ⁻²	>10 ⁻⁵	0.2	21	-0.5
UV30SFA2	Mini	110	310	5.4x10 ⁻²	>10 ⁻⁵	0.2	21	-0.5

Test conditions: T = 25°C
L types are with lens built in
* Radiation resistant version
Radiant Sensitivity: Standard Window

Responsivity: Standard Window
Sensitive Area: Active Diode Area For Types Without Lens
Selectivity: 400-2000 nm
Rise Time: t (63%)

Amplified Output Detectors

Technical Specification

Part Number	Housing	Radiant Sensitivity V/nW	Responsivity V/mW/mm ²	Sensitive Area mm ²	Selectivity	Operating Voltage V	Dark Offset Voltage mV	Rise Time ms	Temperature Coefficient %/K
UV10T2E10F	TO-5	4	0.25	5.4x10 ⁻²	>10 ⁻⁵	2.5-5	<5	10	<-0.3
UV10T2E10L	TO-5	1	10	12.5	>10 ⁻⁵	2.5-5	<5	10	<-0.3

Test conditions: T = 25°C
L types are with lens built in
2E10 is the built-in amplification. Other options on request
Radiant Sensitivity: Standard Window

Responsivity: Standard Window
Sensitive Area: Active Diode Area For Types Without Lens
Selectivity: 400-2000 nm
Rise Time: t (63%)



TO-5 Types

thermopile detectors



Features

- Available in TO-39 and TO-18 housings
- Single, dual or quad elements
- 8 element line arrays and 4x4 matrix arrays with various lens optics and integrated ASIC with multiplexer
- Various filters for optical broad-band or narrow-band applications
- Excellent repeatability of electro-optical parameters
- Ambient temperature reference (thermistor) included
- High sensitivity of several 10 V/W; DC radiation sensitive
- Extremely low temperature coefficient of sensitivity and resistivity
- Constant response over the infrared spectrum
- The absence of microphonic noise effects
- Low susceptibility to electromagnetic pulses (EMP) due to the low internal resistance (<100 kΩ)
- Rugged construction based on CMOS silicon micromachining technology



Typical Applications

- Remote Temperature Sensing, Hand-Held or Industrial Pyrometers
- Ear or Body Thermometers
- Temperature-Sensor Modules in Microwave Ovens, Hair Dryers, Cookers, Toasters
- Sensor Modules for Control of Air Condition Systems (Heat Management, Home, Automotive)
- Temperature Control in Copiers and Printers
- Sensor Arrays for Spatial Temperature Measurements (Imaging Applications)
- Sensors with Infrared Bandpass Filters for Gas Detection by Infrared Absorption

Datasheets available upon request

Description

Thermopile detectors directly sense thermal radiation, providing the perfect device for remotely measuring temperatures without the need for any mechanical chopper. PerkinElmer's proprietary and innovative Si-based micromachining technology guarantees a new generation of components: extreme long-term stability, very low temperature coefficient in sensitivity, and excellent repeatability of electro-optical parameters.

Thermopile sensors allow remote temperature sensing at a low system cost. The sensor does not require cooling, and can reach an accuracy of $\pm 1^\circ\text{C}$, dependent on the measurement range. For narrow temperature ranges, as in body temperature measurement, a precision of 0.1°C is possible.

Single-Element Thermopile Detectors: TPS series

The different available chip sizes and packaging types, together with the variety in window openings with and without a silicon lens, enable the adaptation of the PerkinElmer thermopiles to virtually every application where a remote temperature measurement or control is needed.

Dual- and Quad-Element Types: TPS 2 , TPS 4 series

PerkinElmer offers thermopile detectors with two or four channels, each of which can be equipped with one of the many available infrared spectral bandpass filters. The main application of multiple channel thermopiles is gas detection through IR absorption. Prominent gases to be detected are CO_2 , hydrocarbons and CO.

Thermopile Modules: TPM series

For convenient use, PerkinElmer offers a module with a single-element thermopile sensor, on-board or with an integrated electronic circuit, for the necessary amplification and ambient temperature compensation. This thermopile module is offered as a fully calibrated, ready-to-go sensor. Various temperature ranges and optics are available. Most modules are customized versions.

Thermopile Line and Matrix Arrays: TPL, TPA series

The latest PerkinElmer thermopile technology development features more than a single test spot. The new TPA- (matrix array) and TPL- (line array) series offer multi-element thermopile arrays combined with an optical lens, amplifier, and interface electronics (multiplexer, ambient temperature sensor) in a compact TO-39-type housing. This combines solid-state, non-choppered temperature measurement without the need for in-field calibration.

Typically, the array sensors are sold as a modular type, i.e. on a PCB with external data memory. These TPA- and TPL-Modules are precalibrated with the data stored in an EEPROM. In an application, the associated micro controller (μC) reads this calibration information and converts the sensor signals to the object temperatures.

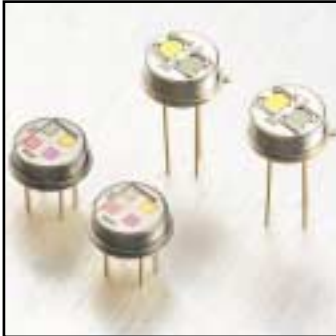

Dual and Quad Element Thermopile Detectors

General Data

Tc of sensitivity (absolute value): 0.02%/K
 Tc of resistance (absolute value): 0.02%/K
 Max. operating temperature: -20 to 100°C
 Max. storage temperature: -40 to 100°C
 Thermistor BETA: 3964 K
 Option for all types: 8-14 um
 Pyrometry filter: G9

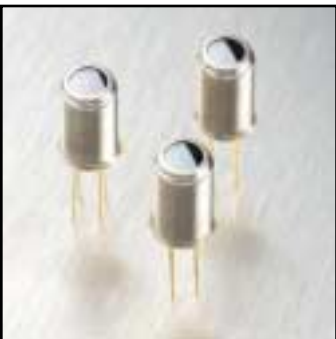

Thermopile Arrays



Thermopile Modules

Single Element Thermopile Detectors

Technical Specification

Part Number	Housing	Field of View	DC Sensitivity V/W	Time Constant ms	Active Area mm ²	TP Chip Resistance kΩ	Noise nV/√Hz	NEP nW/√Hz	D* cm√Hz/W	Thermistor (25°C) kΩ
TPS333	TO-18	100°	35	25	0.7x0.7	75	35	1	0.7x10 ⁸	100
TPS334	TO-39	60°	35	25	0.7x0.7	75	35	1	0.7x10 ⁸	30
TPS334L5.5	TO-39**	7°	55	25	0.7x0.7	75	35	0.6	1.1x10 ⁸	30
TPS434	TO-39	55°	35	20	0.5x0.5	35	24	0.7	0.7x10 ⁸	30
TPS434IRA	TO-39***	15°	55	20	0.5x0.5	35	24	0.4	1.1x10 ⁸	30
TPS534	TO-39	80°	20	35	1.2x1.2	50	29	1.4	0.8x10 ⁸	30
TPS535	TO-39	80°	20	35	1.2x1.2	50	29	1.4	0.8x10 ⁸	30

Test conditions: T = 25°C * 500 K black body
 Field of view: at 50% intensity points ** with 5.5 mm lens
 Noise: r.m.s., 300 K *** with int. reflector

Dual and Quad Thermopile Detectors

Technical Specification

Part Number	Housing	Field of View	DC Sensitivity V/W	Time Constant ms	Active Area mm ²	TP Chip Resistance kΩ	Noise nV/√Hz	NEP nW/√Hz	D* cm√Hz/W	Thermistor (25°C) kΩ
TPS2534	TO-39**	2x90°	42	35	1.2x1.2	50	29	0.7	1.8x10 ⁸	30
TPS4339	TO-39***	4x60°	75	25	0.7x0.7	75	35	0.5	1.5x10 ⁸	100

Test conditions: T = 25°C * 500 K black body
 Field of view: at 50% intensity points ** with 2 channels
 Noise: r.m.s., 300 K *** with 4 channels
 Above data are referenced without the bp filter. Option for all types: individual bp filters for each channel

Line and Matrix Arrays

Technical Specification

Part Number	Housing	Number of Pixels	Field of View	Optics	Output Voltage V (80°C object, 20°C ambient)	Object temperature	Noise mV/√Hz (-5-20Hz)
TPLM086L5.5	TO-39 on PCB	8 element line	41°x6°	f/1 optics, f=5.5 mm	0.95	-20-100°C	0.4
TPLM086L3.9	TO-39 on PCB	8 element line	56°x8°	f/1 optics, f=3.9 mm	0.95	-20-100°C	0.4
TPAM166L3.9	TO-39 on PCB	4x4 matrix	41°x32°	f/1 optics, f=3.9 mm	0.95	-20-100°C	0.4

Test conditions: T = 25°C
 Operating voltage: 5 V Sample frequency: 3 kHz
 Operating current: 1 mA Max. operating temperature: -20-100°C
 Zero signal offset: V_{DD}/2 Max. storage temperature: -40-100°C
 Output resistance: 200 Ω Temperature reference slope: 10 mV/K
 Power up time: 0.3 s Temperature reference offset: 0 mV

Modules

Technical Specification

Part Number	Physical Size	Optics	Field of View
TPM	33x17x5	Aperture	100°
TPML/TPMF	33x17x15	Mirror	7°
TPMML5.5	20x17x8	5.5 mm lens	7°

For further details please contact us.

pyroelectric infrared detectors

► Features

- Low noise, high responsivity
- Excellent common-mode balance for dual-element types
- Available in TO-39, TO-5 housings
- Various filter windows for broad-band or narrow-band applications
- Single- and dual-channel devices
- Dual- and quad-type elements for intrusion applications
- Thermally compensated versions for single-element types

► Typical Applications

- Intrusion Alarms
- Motion Detection
- Ceiling-Mount Person Detection
- Gas Analysis
- Non-Contact Infrared Measurements

Datasheets available upon request

Description

Pyroelectric materials produce a charge transfer when they undergo a change in thermal energy. This effect is applied for detectors that show an output signal similar to alternating current with a change in the infrared radiation. Such pyroelectric detectors are used in movement detectors, passive infrared alarms, and automatic light switches. Detectors based on the same principle are used for gas monitoring based on the spectral absorption method.

Dual-Element Types

Dual-element detectors combine two elements which are connected in reverse polarity to each other to one FET source-follower output.

Four-Element Types

Four-element detectors combine four elements to two outputs. The two individual channels allow signal processing to avoid false alarms and provide redundancy.

Ceiling-Mount Detectors

Ceiling-mount detectors have a special element configuration suitable for ceiling lens designs. They combine two or four separate elements into one output.

Single-Element Detectors

This range of detector offers one element with source-follower output. Different element sizes are available. Most of the preferred types have built-in thermal compensation. Special IR windows of narrow bandwidth are offered.

Dual-Channel Detectors

These special designs offer two single-element detectors in one TO-5 case. Each one is equipped with an individual filter and provides its own output. Various narrow-band filter windows can be chosen.

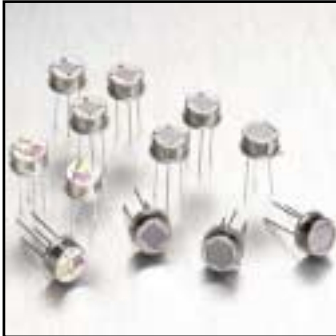

Pyroelectric Infrared Detectors

General Data

Max. Operating Temperature:
-40 to +85°C
Max. Storage Temperature:
-40 to +85°C
Operating Voltage: 2-12 V/47 kΩ
Load Resistor
Offset Voltage: 0.2-1.5 V/47 kΩ
Load Resistor



Ceiling Mount Series



Dual Channel Series

Dual-Element Detectors

Technical Specification

Part Number	Housing	Responsivity V/W typ. (1 Hz)	Noise μ Vpp typ.	NEP W \sqrt Hz typ.	D* cm \sqrt Hz/W typ.	Field of View		Element Size mm ²
						Horizontal	Vertical	
LHi954	TO-39	3700	20	8.1x10 ⁻¹⁰	1.75x10 ⁷	110°	110°	2x1/2x1
LHi958	TO-5	3700	20	8.1x10 ⁻¹⁰	1.75x10 ⁷	110°	110°	2x1/2x1
LHi968	TO-5	4000	20	7.5x10 ⁻¹⁰	1.9x10 ⁷	100°	100°	2x1/2x1
LHi874	TO-39	4200	20	7.5x10 ⁻¹⁰	1.9x10 ⁷	90°	95°	2x1/2x1
LHi878	TO-5	4200	20	7.5x10 ⁻¹⁰	1.9x10 ⁷	90°	95°	2x1/2x1

Test conditions: T = 22°C
Responsivity: 100°C Black Body
Noise: 0.4 to 10 Hz Bandwidth
NEP:100°C Black Body, 1 Hz Electr. Bandwidth, 1 Hz
D*: 100°C Black Body, 1 Hz Electr. Bandwidth, 1 Hz

Four-Element Detectors

Technical Specification

Part Number	Housing	Responsivity V/W typ. (1 Hz)	Noise μ Vpp typ.	NEP W \sqrt Hz typ.	D* cm \sqrt Hz/W typ.	Field of View		Element Size mm ²
						Horizontal	Vertical	
LHi1148	TO-5	4500	30	8.6x10 ⁻¹⁰	14x10 ⁷	108°	67°	0.8x1.2 ea.
LHi1448	TO-5	6500	30	8.6x10 ⁻¹⁰	14x10 ⁷	108°	67°	0.9532 ea.
LHi1548	TO-5	5000	30	8.6x10 ⁻¹⁰	14x10 ⁷	108°	67°	0.9532 ea.

Test conditions: T = 22°C
Responsivity: 100°C Black Body
Noise: 0.4 to 10 Hz Bandwidth
NEP:100°C Black Body, 1 Hz Electr. Bandwidth, 1 Hz
D*: 100°C Black Body, 1 Hz Electr. Bandwidth, 1 Hz

Ceiling-Mount Application Detectors

Technical Specification

Part Number	Housing	Responsivity V/W typ. (1 Hz)	Noise μ Vpp typ.	NEP W \sqrt Hz typ.	D* cm \sqrt Hz/W typ.	Field of View		Element Size mm ²
						X	Y	
LHi906	TO-5	4000	20	7.5x10 ⁻¹⁰	719x10 ⁷	150°	150°	2.66 ea. (round)
LHi1128	TO-5	8000	40	7.5x10 ⁻¹⁰	28x10 ⁷	156°	144°	1.0x1.0 (4 elements)

Test conditions: T = 22°C
Responsivity: 100°C Black Body
Noise: 0.4 to 10 Hz Bandwidth
NEP:100°C Black Body, 1 Hz Electr. Bandwidth, 1 Hz
D*: 100°C Black Body, 1 Hz Electr. Bandwidth, 1 Hz

Single-Element Detectors

Technical Specification

Part Number	Housing	Responsivity V/W typ. (10 Hz)	Noise nV _{RMS} (10Hz)	NEP W \sqrt Hz typ.	D* cm \sqrt Hz/W typ.	Field of View		Element Size mm ²
						X	Y	
LHi807	TO-5	640	600	9.4x10 ⁻¹⁰	16x10 ⁷	135°	120°	1.5x1.5
LHi807TC	TO-5	320	300	9.4x10 ⁻¹⁰	16x10 ⁷	135°	120°	1.5x1.5
PYS4198	TO-5	300	150	20x10 ⁻¹⁰	8x10 ⁷	130°	110°	2.0x2.0
PYS4198TC	TO-5	150	75	20x10 ⁻¹⁰	8x10 ⁷	130°	110°	2.0x2.0
PYS3151TC	TO-18	640	600	9.4x10 ⁻¹⁰	16x10 ⁷	90°	90°	1.5x1.5

Test conditions: T = 22°C
Responsivity: 100°C Black Body
Noise: 0.4 to 10 Hz Bandwidth
NEP:100°C Black Body, 1 Hz Electr. Bandwidth, 1 Hz
D*: 100°C Black Body, 1 Hz Electr. Bandwidth, 1 Hz

Dual-Channel Detectors

Technical Specification

Part Number	Housing	Responsivity V/W typ. (10 Hz)	Noise nV _{RMS} (10 Hz)	NEP W \sqrt Hz typ.	D* cm \sqrt Hz/W typ.	Field of View		Element Size mm ²
						X (ea.)	Y (ea.)	
LHi814G1/G20	TO-5	640	600	9.4x10 ⁻¹⁰	16x10 ⁷	77°	95°	1.5x1.5 (ea.)
LHi814G2/G20	TO-5	640	600	9.4x10 ⁻¹⁰	16x10 ⁷	77°	95°	1.5x1.5 (ea.)

Test conditions: T = 22°C
Responsivity: 100°C Black Body
Noise: 0.4 to 10 Hz Bandwidth
NEP:100°C Black Body, 1 Hz Electr. Bandwidth, 1 Hz
D*: 100°C Black Body, 1 Hz Electr. Bandwidth, 1 Hz
Each of these types can be equipped with two different narrow band infrared filters.

analog optical isolators



Features

- High input-to-output voltage isolation
- True resistance element output
- Single- or dual-element outputs available
- Low cost
- Suitable for AC or DC use
- Wide range of input-to-output characteristics
- Low drive current
- Low “on” resistance, high “off” resistance
- Complete solid-state construction



Typical Applications

- DC Isolators
- Feedback Elements in Automatic Gain Control Circuits
- Audio Limiting and Compression
- Noiseless Switching
- Logic Interfacing
- Remote Gain Control for Amplifiers
- Photochoppers
- Noiseless Potentiometers



Principle of Operation

Analog Optical Isolators are used in many different types of circuits and applications.



Available Related Products

VTL5C Series
LT3011 Series
LT9900 Series

Datasheets available upon request

Description

PerkinElmer Optoelectronics has been a leading manufacturer of analog optical isolators (AOI) for over twenty years and makes a broad range of standard parts under its trademark VACTROL®.

There are many kinds of optical isolators, but the most common is the LED/phototransistor type. Other familiar types use output elements such as light-sensitive SCRs, Triacs, FETs and ICs. The major application for these silicon-based devices is to provide electrical isolation of digital lines connected between different pieces of equipment. The principle of operation is very simple. When an input current is applied to the LED, the output phototransistor turns on. The only connection between the LED and phototransistor is through light—not electricity—thus the term optical isolator. These optical isolators are primarily digital in nature with fast response times for interfacing with logic gates. Rise and fall times of a few microseconds, faster for some isolators, are typical.

The AOI also uses an optical link between input and output. The input element is an LED and the output element is always a photoconductive cell or, simply a photocell. Together, the coupled pair act as an electrically variable potentiometer. Since the output element of the AOI is a resistor, the voltage applied to this output resistor may be DC and/or AC and the magnitude may be as low as zero or as high as the maximum voltage rating. Because the input will control the magnitude of a complex waveform in a proportional manner, this type of isolator is an analog-control element. AOIs may be used in the ON-OFF mode but the fastest response time is only in the millisecond range. A level-sensitive Schmitt trigger is required between the AOI and logic gates when used in digital circuits.

Absolute Maximum Ratings @ 25°

Maximum Temperatures	
Storage and Operating:	–40°C to 75°C
Cell Power:	175 mW
Derate Above 30°C:	3.9 mW/°C
LED Current:	40 mA
Derate Above 30°C:	0.9 mA/°C
LED Reverse Breakdown Voltage:	3.0 V
LED Forward Voltage Drop @ 20 mA:	2.0 V (1.65 V Typ.) VTL5C8 = 2.8 V (2.2 V typ.) VTL5C9 = 2.8 V (2.2 V typ.) VTL5C10 = 2.8 V (2.2 V typ.)
Minimum Isolation Voltage @	
70% Rel. Humidity:	2500 VRMS
Output Cell Capacitance:	5.0 pF
Input/Output Coupling Capacitance:	0.5 pF

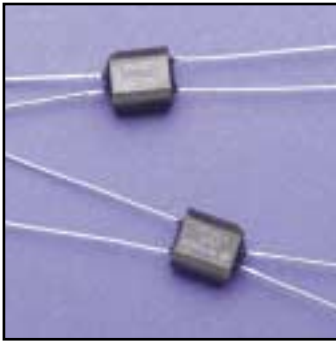

Analog Optical Isolators— VTL5C Series

PerkinElmer Optoelectronics' line of AOIs consists of a light-tight package which houses a light source and one or more photoconductive cells. Through control of the input current or voltage applied to the AOI, the output resistance can be varied. The output resistance can be made to switch between an "on" and "off" state or made to track the input signal in an analog manner. Because a small change in input signal can cause a large change in output resistance, AOIs have been found to provide a very economical and technically superior solution for many applications.

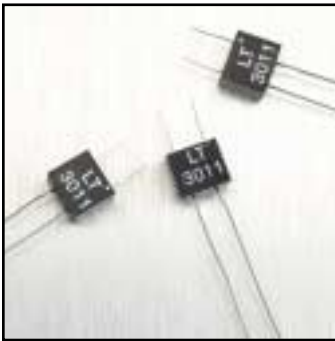

LT Series

LT Series Key

R1mA	Output Resistance at If=1 mA
R20mA	Output Resistance at If=20 mA
R01	Dark Resistance after 1 sec (If=0)
R05	Dark Resistance after 5 sec (If=0)
T _{op}	Operating Temperature Range
T _{st}	Storage Temperature Range
V _i	Input/Output Insulation Voltage
TC	Module Thermal Coefficient
T _{on}	Rise Time to 63% of final R ₂₀
T _{off}	Decay Time to 37% of initial R ₂₀
C _s	Output Capacity
V _{max}	Operating Voltage at If=0
P _{max}	Output Power Dissipation at 25°C

VTL5C Series

Technical Specification

Part Number	Material Type	On Resistance		Off Resistance @ 10 sec. min.	Slope	Dynamic Range	Cell Voltage	Response Time	
		Input Current	Dark Adapted typ.					Turn-on to 63% Final R _{ON} typ.	Turn-off (Decay) to 100Ω max.
VTL5C1	1	1 mA	20 kΩ	50 MΩ	15	100 db	100 V	2.5 ms	35 ms
		10 mA	600 Ω						
		40 mA	200 Ω						
VTL5C2	0	1 mA	5.5 kΩ	1 MΩ	24	69 db	200 V	3.5 ms	500 ms
		10 mA	800 Ω						
		40 mA	200 Ω						
VTL5C2/2	0	5 mA	2.5 kΩ	1 MΩ	20	65 db	50 V	7 ms	150 ms
VTL5C3	3	1 mA	30 kΩ	10 MΩ	20	75 db	250 V	2.5 ms	35 ms
		10 mA	5 Ω						
		40 mA	1.5 Ω						
VTL5C3/2	3	1 mA	55 kΩ	10 MΩ	19	71 db	100 V	3 ms	50 ms
		40 mA	2 kΩ						
VTL5C4	4	1 mA	1.2 kΩ	400 kΩ	18.7	72 db	50 V	6 ms	1.5 sec
		10 mA	125 Ω						
		40 mA	75 Ω						
VTL5C4/2	4	1 mA	1.5 kΩ	400 kΩ	8.3	68 db	30 V	6 ms	1.5 sec
		10 mA	150 Ω						
VTL5C6	0	1 mA	75 kΩ	100 MΩ	16.7	88 db	250 V	3.5 ms	50 ms (1 MΩ)
		10 mA	10 kΩ						
		40 mA	2 kΩ						
VTL5C7	7	0.4 mA	5 kΩ	1 MΩ	5.7	75 db	50 V	6 ms	1 sec. (100 kΩ)
		2 mA	1.1 kΩ						
VTL5C8	0	1 mA	4.8 kΩ	10 MΩ	8	80 db	500 V	4 ms	60 ms
		4 mA	1.8 kΩ						
		16 mA	1 kΩ						
VTL5C9	1	2 mA	630 Ω	50 MΩ	7.3	112 db	100 V	4 ms	50 ms
VTL5C10	4	1 mA	400 Ω	400 kΩ	3.8	75 db	50 V	1 ms	1.5 sec

Specification Notes

LED Current: Since the input has a substantially constant voltage drop, a current-limiting resistance is required.

ON Resistance: Dark adapted resistance measured after 24 or more hours of no input.

OFF Resistance: Measured 10 sec. after removal of the input. The ultimate resistance is many times greater than the value at 10 sec.

Response Time: Ascent measured to 63% of final conductance from the application of 40 mA input. The conductance rise time

to a specified value is increased at reduced input drive while the conductance decay time to a specified value is decreased.

Typical matching and tracking from 0.4 to 40 mA is 25%.

Measured 5 sec. after removal of the input. The ultimate resistance is many times greater than the value at 5 sec.

VTL5C9 response times are based on a 2 mA input. VTL5C10 response times are based on a 10 mA input for ascent time and a 1 mA input for decay time.

LT Series

Technical Specification

Part Number	Typical Electro-Optical Characteristics						Limit Values						
	R1mA kΩ	R20mA typ. kΩ	R01 min. mΩ	R05 min. mΩ	T _{op} range °C	T _{st} range °C	V _i min. V	TC 10 lux %/K	T _{on} msec	T _{off} typ. msec	C _s max. pF	V _{max} V	P _{max} mW
LT3011-2	—	1	3	9	-20-+60	-20-+80	2500	2	10	10	2	50	50
LT3011	—	0.32	0.1	0.3	-20-+70	-20-+70	2500	0.4	50	40	2	100	75
LT9909	0.7-1.2	0.35	0.06	0.18	-20-+70	-20-+70	1000	0.4	40	40	1	50	50
LT9910	1.2-2.5	0.7	0.06	0.18	-20-+70	-20-+70	1000	0.4	40	40	1	50	50
LT9911	2-5	1.5	0.1	0.3	-20-+70	-20-+70	1000	0.4	50	40	1	100	50
LT9912	4.5-9	2	0.2	0.6	-20-+70	-20-+70	1000	0.4	40	30	1	100	50
LT9913	8-16	3.5	0.5	1.5	-20-+70	-20-+70	1000	0.4	35	30	1	100	50
LT9914	14-25	6	0.7	2.1	-20-+70	-20-+70	1000	0.4	35	30	1	100	50

All readings taken at standard light A (2854 K color temperature) after 2 hours of preillumination at 500 lux.

Input/Output Coupling Capacity: 1 pF max.

Reverse Voltage: 4 V max.

Diode Forward Current: 25 mA max. DC

infrared interruptive switches

- **Features**
- Contains no mechanical parts to wear out
 - Provides non-contact sensing of objects
 - Low power consumption, compatible with solid-state electronics
 - Low cost
 - Capable of sensing any opaque object
 - Small size
 - Custom mechanical configurations available
 - Can be specially selected or built to meet the requirements of your particular application

- **Typical Applications**
- Printers and Typewriters
 - Paper Sensor
 - Paper-Feed Detector
 - Imprinting Head Position Detector
 - Floppy Disk Drives
 - Track-Zero Sensor
 - Index Sensor
 - Disk-In Sensor
 - Vending Machines
 - Coin Sensor
 - Detection of Goods
 - Mechanism Position
 - Facsimiles
 - Original Width Detection
 - Initial Position Detection
 - Final Position Detection
 - Industrial
 - Rotational Speed/Position Detection (Encoder)
 - Distance Detection
 - Object Sensor
 - VHS/VHSC/8 mm VCR
 - Tape Start
 - Tape Load
 - Tape End
 - Copiers
 - Paper-Presence Detection
 - Toner-Density Control
 - Paper-Carrier Detection

Datasheets available upon request

Description

PerkinElmer Optoelectronics' infrared interruptive switches are ideal for non-contact sensing applications. The emitter is generally an IR LED and the detector is either a phototransistor or a photodarlington.

Optoswitches, Optical Hybrids, and Custom Optical Assemblies

Optoswitches, optical hybrids, custom assemblies, photodiodes, phototransistors, IR emitters, and photoconductive cells are commonly used in industrial, commercial, and consumer electronics applications. This product line is one of the broadest in the industry and includes a variety of standard catalog products as well as custom design and manufacturing capabilities. Approximately 75% of the products shipped are custom designed and tested to serve the needs of specific OEM applications.

Reflective Optoswitches

Reflective optical switches combine an infrared-emitting diode (IRED) with an NPN phototransistor or photodarlington in a one-piece, sealed, IR-transmitting plastic case. Sealed construction improves resistance to moisture and debris. Units are available with PC-board mounting leads (VTR16D1), or 12-inch, #26 AWG flying leads (VTR17D1).

Transmissive Optoswitches

Interrupter-type optical switches combine an infrared-emitting diode (IRED) with an NPN phototransistor. Units are available in two different case styles; a one-piece, sealed, IR-transmitting plastic case (VTL11 and VTL13 series) and an opaque case (VTL23 series). Options also include apertures-over-detector and/or emitter, and either PC-board mount leads or 12-inch, #26 AWG leads (VTL13 only).

General Characteristics

Parameter	Symbol	Conditions	Input IRED	Output Detector
Reverse Voltage	V_R	$I_R=100 \mu A$	2 V min.	
Continuous Forward Current	I_F	Derate 0.73 mA/°C above 30°C	40 mA max.	
Forward Voltage Drop	V_F	$I_F=20 \text{ mA}$	1.8 V max.	
Collector Breakdown Voltage	$V_{BR(CEO)}$	$I_C=100 \mu A$	30 V min.	
Emitter Breakdown Voltage	$V_{BR(EO)}$	$I_C=100 \mu A$ $I_E=100 \mu A$ (VTR)	5 V min. 3 V min. (VTL23DxA)	
Power Dissipation	P_D	Derate 0.91 mW/°C above 30°C	50 mW max.	

(@ 25°C unless otherwise noted)

Absolute Maximum Ratings

Maximum Temperatures

Storage and Operating: -40°C to 85°C

Lead-Soldering Temperature: 260°C (1.6 mm from case, 5 sec. max.)

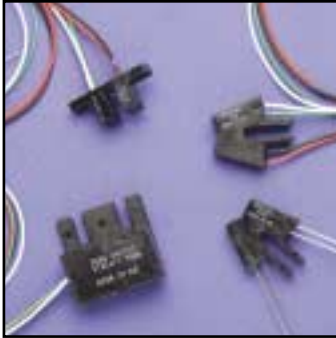

**Infrared Interruptive Switches—
Reflective Optoswitches
VTR Series**

**Transmissive Optoswitches
VTL11d Series, VTL13D Series,
VTL23DxA Series**

VTR Series

Technical Specification

Part Number	Light Current, I_p Test Conditions				Dark Current Test Conditions			Output Element Detector Device
	mA min.	I_f mA	V_{CE} Volts	d inches (mm)	μ A max.	I_f mA	V_{CE} Volts	
VTR16D1	0.3	20	5	0.1 (2.5)	0.1	0	5	Phototransistor
VTR17D1	0.3	20	5	0.1 (2.5)	0.1	0	5	Phototransistor
VTR24F1	6.0	20	30	2.0 (50.8)	—	—	—	Photodarlington

Specification Notes

The case material is polysulfone and should be cleaned with alcohol or freon TF only. Avoid chlorinated hydrocarbons and solvents such as acetone or toluene, as damage may result.

The light current is measured using a 90% reflective surface at a specified distance.

The dark current is measured with the part totally shielded from ambient light. With 2150 lux (200 fc) from a cool white fluorescent lamp perpendicular to the sensing axis, the

detector current will be typically 3 μ A. The same illumination concentric to the sensing axis will result in a detector current of 50 μ A. Equivalent light from an incandescent lamp will result in significantly greater currents.

With the specified IRED forward current and no reflecting surface, the crosstalk is typically less than 3 μ A.

Accommodates most applications.

VTL11D, 13D Series

Technical Specification

Part Number	Light Current, I_p Test Cond.			Dark Current Test Cond.			Saturation Volts Test Cond.			Aperture Combination	
	mA min.	I_f mA	V_{CE} Volts	nA max.	I_f mA	V_{CE} Volts	Volts max.	I_f mA	I_c mA	Emitter	Detector
D1	0.5	20	5	100	0	10	0.4	20	0.25	none	none
D1-20	0.15	20	5	100	0	10	0.4	20	0.25	0.02" w	none
D3	2	20	5	100	0	10	0.4	20	1.8	none	none
D3-20	0.6	20	5	100	0	10	0.4	20	1.8	0.02" w	none
D5-20	0.15	20	5	100	0	10	0.4	20	0.25	0.02" w	0.01" w
D6-20	0.075	20	5	100	0	10	0.4	20	0.25	0.02" w	0.005" w
D7	0.75	20	5	100	0	10	0.4	20	0.25	none	0.02" w
D7-20	0.225	20	5	100	0	10	0.4	20	0.25	0.02" w	0.02" w

Specification Notes

The dark current is measured with the part totally shielded from ambient light. With 2150 lux (200 fc) from a cool white fluorescent lamp perpendicular to the sensing axis, the detector current will be typically 3 μ A. Equivalent light from an incandescent lamp will result in significantly greater currents.

The aperture used for these slotted switches are 0.04" (1.02 mm) high.

The case material is polysulfone and should be cleaned with alcohol or freon TF only. Avoid chlorinated hydrocarbons and solvents such as acetone or toluene, as damage may result.

VTL11D7-20, VTL13D7-20, accommodate most applications. The other parts in this series are available only for specialized, high-volume applications

VTL23DxA Series

Technical Specification

Part Number	Light Current, I_p Test Cond.			Dark Current Test Cond.			Saturation Volts Test Cond.			Aperture Combination	
	mA min.	I_f mA	V_{CE} Volts	nA max.	I_f mA	V_{CE} Volts	Volts max.	I_f mA	I_c mA	Emitter	Detector
VTL23D0A21	0.2	20	10	100	0	10	0.4	20	0.1	0.02" w	0.01" w
VTL23D0A22	0.2	20	10	100	0	10	0.4	20	0.1	0.02" w	0.02" w
VTL23D1A00	0.5	20	10	100	0	10	0.4	20	0.4	0.04" w	0.04" w
VTL23D1A22	0.5	20	10	100	0	10	0.4	20	0.4	0.02" w	0.02" w
VTL23D2A00	2.5	20	10	100	0	10	0.6	20	1.8	0.04" w	0.04" w
VTL23D3A00	1.0	10	10	100	0	10	0.4	10	0.8	0.04" w	0.04" w

Specification Notes

The dark current is measured with the part totally shielded from ambient light.

VTL23D2A00 and VTL23D3A00 contains a visible light-blocking dust cover over the apertures.

The plastic case can be damaged by chlorinated hydrocarbons and ketones. Methanol isopropanol alcohols are recommended as cleaning agents.

VTL23D1A22 accommodate most applications. The other parts in this series are available only for specialized, high-volume applications.

Aperture Length is 0.075"

phototransistors



Features

- Low-cost visible and near-IR photodetection
- Available with gains from 100 to over 1500
- Moderately fast response times
- Available in a wide range of packages including epoxy-coated, transfer-molded, cast, hermetic packages, and in chip form
- Usable with almost any visible or near-infrared light source such as IREDs; neon, fluorescent, incandescent bulbs; lasers; flame sources; sunlight; etc.
- Same general electrical characteristics as familiar signal transistors



Typical Applications

- Computer/Business Equipment
 - Write-Protect Control
 - Margin Controls—Printers
- Industrial
 - LED Light Source—Light Pens
 - Security Systems
 - Safety Shields
- Consumer
 - Coin Counters
 - Lottery Card Readers
 - Position Sensors—Joysticks
 - Remote Controllers—Toys, Appliances, Audio/Visual Equipment
 - Games—Laser Tag
 - Camera Shutter Control



Principle of Operation

Phototransistors are solid-state light detectors that possess internal gain. They can be used to provide either an analog or digital output signal.

Datasheets available upon request

Description

Phototransistors are photodiode-amplifier combinations integrated within a single silicon chip. These are combined to overcome the major fault of photodiodes: unity gain. Many applications demand a greater output signal from the photodetector than can be generated by a photodiode alone. While the signal from a photodiode can always be amplified through use of an external op-amp or other circuitry, this approach is often not as practical or as cost-effective as the use of phototransistors. The phototransistor can be viewed as a photodiode whose output photocurrent is fed into the base of a conventional small-signal transistor. While not required for operation of the device as a photodetector, a base connection is often provided, allowing the designer the option of using base current to bias the transistor. The typical gain of a phototransistor can range from 100 to over 1500.

Phototransistors can be used as ambient-light detectors. When used with a controllable light source, typically an IRED, they are often employed as the detector element for optoisolators and transmissive or reflective optical switches.

Absolute Maximum Ratings

Maximum Temperatures

Storage and Operating:

-40°C to 100°C

-40°C to 110°C (VTT1015, VTT1016, VTT1017, VTT1115, VTT1116, and VTT1117)

-40°C to 85°C (VTT7222, VTT7223,

VTT7225, VTT7122, VTT7123, and VTT7125)

-40°C to 70°C (VTT9002, VTT9003,

VTT9102, and VTT9103)

Continuous Power Dissipation: 50 mW

100 mW (VTT9002, VTT9003, VTT9102, and VTT9103)

250 mW (VTT1015, VTT1016, VTT1017, VTT1115, VTT1116, and VTT1117)

Derate above 30°C:

0.71 mW/°C

2.5 mW/°C (VTT9002, VTT9003, VTT9102, and VTT9103)

3.12 mW/°C (VTT1015, VTT1016, VTT1017, VTT1115, VTT1116, and VTT1117)

0.91 mW/°C (VTT7122, VTT7123, VTT7125)

Maximum Current:

25 mA

200 mA (VTT1015, VTT1016, VTT1017, VTT1115, VTT1116, and VTT1117)

Lead-Soldering Temperature:

260°C (1.6 mm from case, 5 sec. max.)

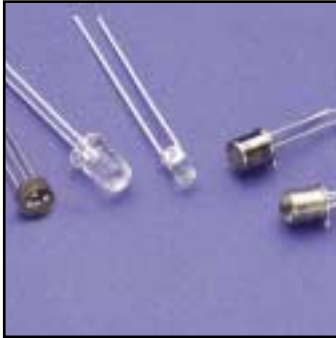

NPN Phototransistors

.25", small area, high speed
 .04", medium area, high sensitivity
 .05", large area, high sensitivity

Table Key

I_C	Light Current
I_{CEO}	Dark Current H=0
$V_{BR(CEO)}$	Collector Breakdown $I_C=100 \mu\text{A}$, H=0
$V_{BR(ECO)}$	Emitter Breakdown $I_E=100 \mu\text{A}$, H=0
$V_{CE(SAT)}$	Saturation Voltage $I_C=1\text{mA}$, H=400 fc
t_r/t_f	Rise/Fall Time $I_C=1 \text{mA}$, $R_L=100 \Omega$

Clear T-1 3/4 (5 mm) Plastic Package

VTT1212 VTT1223W VTT1227
 VTT1214 VTT1225
 VTT1222W VTT1226

Clear Long T-1 (3 mm) Plastic Package

VTT3323LA VTT3324LA VTT3325LA

IRT Long T-1 (3 mm) Plastic Package

VTT3423LA VTT3424LA VTT3425LA

Molded, Lensed Lateral Package

VTT7122 VTT7123 VTT7125

IRT Molded, Lensed Lateral Package

VTT7222 VTT7223 VTT7225

Clear Epoxy TO-106 Ceramic Package

VTT9002 VTT9003

Epoxy Lensed TO-106 Ceramic Package

VTT9102 VTT9103

TO-46 Flat Window Package

VTT1015 VTT1016 VTT1017

TO-46 Lensed Package

VTT1115 VTT1116 VTT1117

.025" NPN Phototransistors

Technical Specification

Part Number	Light Current		Dark Current		$V_{BR(CEO)}$ Volts min.	$V_{BR(ECO)}$ Volts min.	$V_{CE(SAT)}$ Volts max.	t_r/t_f μsec , typ.	Angular Response $\theta_{1/2}$
	mA min.	H fc (mW/cm ²) $V_{CE}=5 \text{V}$	nA max.	V_{CE} Volts					
VTT1222W	0.9	100 (5)	10	20	50	6	0.25	2	$\pm 40^\circ$
VTT1223W	1.5	100 (5)	10	20	40	6	0.25	3	$\pm 40^\circ$
VTT1225	4	100 (5)	100	10	30	5	0.25	1.5	$\pm 5^\circ$
VTT1226	7.5	100 (5)	100	10	30	5	0.25	3	$\pm 5^\circ$
VTT1227	12	100 (5)	100	10	30	5	0.25	4	$\pm 5^\circ$
VTT3323LA	2	20 (1)	100	10	30	5	0.25	3	$\pm 10^\circ$
VTT3324LA	4	20 (1)	100	10	30	5	0.25	4	$\pm 10^\circ$
VTT3325LA	6	20 (1)	100	10	30	5	0.25	5	$\pm 10^\circ$
VTT3423LA	1	20 (1)	100	10	30	5	0.25	3	$\pm 10^\circ$
VTT3424LA	2	20 (1)	100	10	30	5	0.25	4	$\pm 10^\circ$
VTT3425LA	3	20 (1)	100	10	30	5	0.25	5	$\pm 10^\circ$
VTT7122	1	100 (5)	100	10	30	5	0.25	2	$\pm 36^\circ$
VTT7123	2	100 (5)	100	10	30	5	0.25	2	$\pm 36^\circ$
VTT7125	4.5	100 (5)	100	10	30	5	0.25	2	$\pm 36^\circ$
VTT7222	0.9	100 (5)	100	10	30	5	0.25	2	$\pm 36^\circ$
VTT7223	1.8	100 (5)	100	10	30	5	0.25	2	$\pm 36^\circ$
VTT7225	4	100 (5)	100	10	30	5	0.25	4	$\pm 36^\circ$

Electro-Optical Characteristics @ 25°C

.04" NPN Phototransistors

Technical Specification

Part Number	Light Current		Dark Current		$V_{BR(CEO)}$ Volts min.	$V_{BR(ECO)}$ Volts min.	$V_{CE(SAT)}$ Volts max.	t_r/t_f μsec , typ.	Angular Response $\theta_{1/2}$
	mA min.	H fc (mW/cm ²) $V_{CE}=5 \text{V}$	nA max.	V_{CE} Volts					
VTT1212	2	20 (1)	100	10	30	5	0.25	4	$\pm 10^\circ$
VTT1214	4	20 (1)	100	10	30	5	0.25	6	$\pm 10^\circ$
VTT9002	2	100 (5)	100	10	30	6	0.55	4	$\pm 50^\circ$
VTT9003	5	100 (5)	100	10	30	6	0.55	6	$\pm 50^\circ$
VTT9102	6	100 (5)	100	5	30	4	0.55	6	$\pm 42^\circ$
VTT9103	13	100 (5)	100	5	30	4	0.55	10	$\pm 42^\circ$

Electro-Optical Characteristics @ 25°C

.05" NPN Phototransistors

Technical Specification

Part Number	Light Current		Dark Current		$V_{BR(CEO)}$ Volts min.	$V_{BR(ECO)}$ Volts min.	$V_{CE(SAT)}$ Volts max.	t_r/t_f μsec , typ.	Angular Response $\theta_{1/2}$
	mA min.	H fc (mW/cm ²) $V_{CE}=5 \text{V}$	nA max.	V_{CE} Volts					
VTT1015	0.4	100 (5)	25	20	40	6	0.4	5	$\pm 35^\circ$
VTT1016	1	100 (5)	25	20	30	6	0.4	5	$\pm 35^\circ$
VTT1017	2.5	100 (5)	25	10	20	4	0.4	8	$\pm 35^\circ$
VTT1115	1	20 (1)	100	10	30	6	0.4	5	$\pm 15^\circ$
VTT1116	2	20 (1)	100	10	30	4	0.4	8	$\pm 15^\circ$
VTT1117	4	20 (1)	100	10	30	4	0.4	8	$\pm 15^\circ$

Electro-Optical Characteristics @ 25°C

buffered multiplexers



XL-1 Variable-Gain Multiplexers

Description

PerkinElmer Optoelectronics' CMOS buffered multiplexers offer the ideal solution to the increasing demand for low noise amplification and multiplexing applications. They are designed to interface with a variety of photosensitive arrays constructed from materials such as amorphous silicon, gallium arsenide, germanium or mercury cadmium telluride. These devices, available in 64, 128 and 256 channel models, are widely used in medical, scientific, and industrial applications to read electrical signals generated by x-ray, infrared, and other radiation beyond the direct detection range of silicon.

XL-1 Variable-Gain Multiplexers

These advanced devices offer a versatile solution to the increasing demand for low noise amplification and multiplexing. They are designed to interface with linear photosensitive arrays, such as those made of gallium arsenide, germanium or amorphous silicon, or any of several special purpose infrared-sensitive materials. Each channel of the multiplexer consists of a charge amplifier in series with two separate buffered sample-and-hold paths for correlated double sampling (CDS). A broad range of electrically selectable integrating capacitors provide accommodation for charge packets from a wide range of sensor materials, pixel sizes and exposure levels.

XL-1 multiplexers are available in 64, 128 or 256 active channels, all with 100 μ m channel-to-channel spacing. They offer a dynamic range in excess of 90 db, low offset voltage, bidirectional readout, and integrated calibration facilities.

Multiplexer Individual Channel Schematic

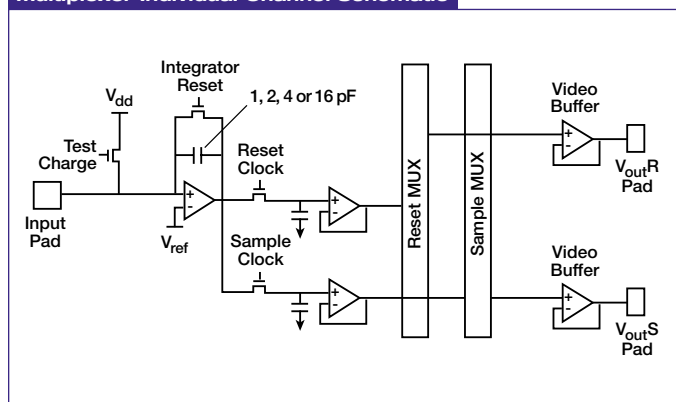

image tubes



High-Resolution Image Tubes

Description

The use of image tubes in special applications is indispensable. The camera tube is superior to solid-state image sensors in high-resolution television systems with high frame-repetition rates. The essential characteristics of the camera tubes, such as absolute and spectral sensitivity, resolution and lag are determined by the photoconducting material (target) and the electron optical parameters of the scanning electron beam.

Resistron Tubes

These are universally applied low cost image tubes. The target material is Antimony Trisulfide (Sb_2S_3) which provides good resolution and integration of quantum noise.

Saticon Tubes

Saticon Tubes with a Selenium storage layer (SeAsTe) are suited for acquiring fast moving images, especially in medical applications. Their typical characteristics: low lag, excellent resolution and signal uniformity.

Newvicon Tubes

Worldwide, these tubes have been taken out of production. We offer Resistron tubes as a close equivalent to replace Newvicons.

Industrial and Surveillance 2/3" Tubes

Technical Specification

Part Number	Version	Characteristics	Length mm	Diameter mm	Facepl. Temperature °C	Dark Current nA	Illumination lx
XQ1305	Resistron	electrostatic focusing	108	19.8	30+/-2	20	10
XQ1371	Resistron	large dyn. range, gr.1	103	19.8	30+/-2	20	10
XQ1372	Resistron	gr.2	103	19.8	30+/-2	20	10

Industrial and Surveillance 1" Tubes

Technical Specification

Part Number	Version	Characteristics	Length mm	Diameter mm	Facepl. Temperature °C	Dark Current nA	Illumination lx
XQ1292	Resistron	large dyn. range, gr.1	162	28.6	30+/-2	20	10
XQ1293	Resistron	gr.2	162	28.6	30+/-2	20	10

Special TV 2/3" Tubes

Technical Specification

Part Number	Version	Characteristics	Length mm	Diameter mm	Facepl. Temperature °C	Dark Current nA	Illumination lx
XQ1371SF	Resistron	radiation resistant	103	19.8	30+/-2	20	10
XQ1372SF	Resistron	with reticles	103	19.8	30+/-2	20	10
XQ1380	Newvicon	radiation resistant	108	19.8	25+/-2	2(<4)	1

Special TV 1" Tubes

Technical Specification

Part Number	Version	Characteristics	Length mm	Diameter mm	Facepl. Temperature °C	Dark Current nA	Illumination lx
XQ1292F	Resistron	fiberoptic faceplate	162	28.6	30+/-2	20	10
XQ1292SF	Resistron	radiation resistant	162	28.6	30+/-2	20	10
XQ1292RF	Newvicon	with reticles					

Medical 1" Tubes

Technical Specification

Part Number	Version	Characteristics	Length mm	Diameter mm	Facepl. Temperature °C	Dark Current nA	Illumination lx
XQ1290	Resistron	high sensitivity + resolution	162	28.6	30+/-2	30	1.7
XQ1395	Resistron	high resolution / line no.	162	28.6	30+/-2	30	1.7
XQ1560	Saticon	short lag / high beam	162	28.6	30+/-2	<1	1.7
XQ1570	Saticon	low lag / high beam	162	28.6	30+/-2	<1	1.7
XQ1575	Saticon	with diode gun structure	162	28.6	30+/-2	<1	1.7

line scan imagers



Features

- 2500:1 dynamic range
- Ultra-low image lag
- Electronic exposure control
- Antiblooming control
- Square pixels with 100% fill factor
- Extended spectral range—250-1000 nm



Typical Applications

- High-Speed Document Reading
- Web Inspection
- Mail Sorting
- Production Measurement
- Position Sensing
- Spectroscopy



Principle of Operation

Line scan sensors are ideal for imaging objects in motion on webs or conveyors.

Datasheet available upon request

Description

Line scan sensors are ideal for imaging objects in motion on webs or conveyors. Applications range from inspection of lead frames and labels to scanning mail and parcels.

P-Series Linear Photodiode Array Imagers

In P-series linear imagers, PerkinElmer has combined the best features of high-sensitivity photodiode array detection and high-speed, charge-coupled scanning to offer an uncompromising solution to the increasing demands of advanced imaging applications. These high-performance imagers feature low noise, high sensitivity, impressive charge-storage capacity, and lag-free dynamic imaging in a convenient 1-output architecture. The 14 μm square contiguous pixels in these imagers reproduce images with minimum information loss and artifact generation, while their unique photodiode structure provides excellent blue response extending below 250 nm in the ultraviolet.

The two-phase CCD readout registers require only modest clocking voltages, yet achieve excellent charge-transfer efficiency.

Additional electrodes provide independent control of exposure and antiblooming. Finally, high-sensitivity readout amplifiers provide a large-output signal to relax the noise requirements on the camera electronics that follow. These versatile imagers are available in array lengths of 512 to 2048 elements with either low-cost glass or UV-enhanced fused silica windows. PerkinElmer Optoelectronics also maintains capabilities to manufacture line scan imagers up to 8192 pixels combined with 4 outputs and 7 or 14 μm pixels with existing designs. Contact PerkinElmer for more information.

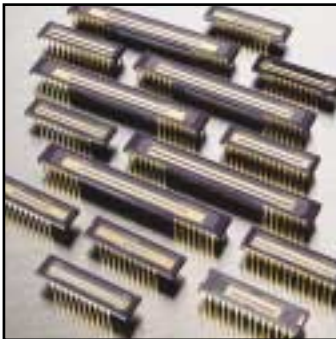

Line Scan Imagers—P Series

P Series

Technical Specification

Part Number	Pixel Count elements	Pixel Size μm	Number of Outputs	Spectral Response Range nm	Pixel Data Rate MHz	Dynamic Range	Horizontal Clocking typ.
RL0512P	512	14x14	1	250-1000	40	2500:1	2 \emptyset @ 5 V
RL1024P	1024	14x14	1	250-1000	40	2500:1	2 \emptyset @ 5 V
RL2048P	2048	14x14	1	250-1000	40	2500:1	2 \emptyset @ 5 V

Operating Temperature: 0°C min. to +55°C max.
 Storage Temperature: -25°C min. to +85°C max.
 Lag: <1%
 Saturation Voltage: 600 mV

Spectral Sensitivity Curve

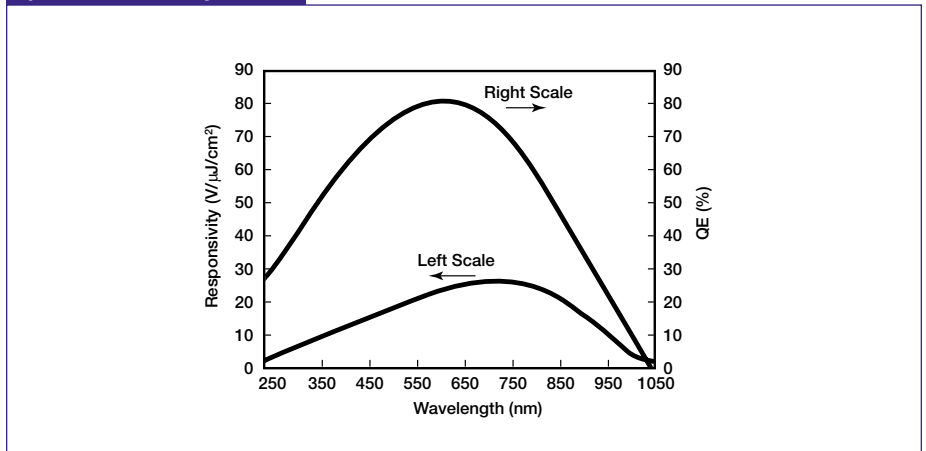

cmos photodiode arrays



Features

- 2.5 mm photodiode aperture
- Extremely low dark leakage current
- Low power dissipation
- Clock-controlled sequential readout at rates up to 1 MHz
- Single-supply operation with HCMOS-compatible inputs
- Single shift register design
- Wide dynamic range
- Differential video output for clock noise cancellation
- High saturation charge 10 pC (25 μm) or 20 pC (50 μm)
- Antiblooming function for low crosstalk
- Line Reset Mode for simultaneous reset of all photodiodes
- Wide spectral response: 300 to 1000 nm
- Polished fused silica window
- On-chip diodes (two) for temperature monitoring



Typical Applications

- Spectroscopy
- Colorimetry

Datasheet available upon request

Description

For nearly thirty years, PerkinElmer Optoelectronics has been a leader in the development of sensors for spectroscopy. In spectroscopy and other instrumentation applications, large pixels, very high charge storage capacity, low readout noise and dark current, and direct access to the charge packet are all critical to delivering the high dynamic range and linear response demanded. The CMOS photodiode array architecture meets all of these needs in a way no other sensor technology can match.

L-Series Visible Range Spectroscopy Arrays

PerkinElmer Optoelectronics' L-series CMOS linear photodiode arrays offer a high-quality, low-cost solution for spectroscopy and colorimetry applications in the 300-1000 nm range. The L-Series family's combination of high sensitivity, low dark current, low switching noise and high saturation charge provides excellent dynamic range and great flexibility in setting integration time.

L-series sensors consist of a linear array of silicon photodiodes, each connected to a MOS switch for readout controlled by an integrated shift register scanning circuit. Under external clock control, the shift register sequentially enables each of the switches, directing the charge on the associated photodiode to an output line. A dummy output provides clock noise cancellation. L-series devices are mounted in ceramic side-brazed, 22-pin, dual-inline packages with ground and polished fused silica windows and are pin-compatible with earlier PerkinElmer SB and TB-series sensors.

L-series models are available with pixel spacings of 25 μm and 50 μm and lengths from 128 to 1024 pixels. All models feature a 2500 μm pixel aperture to simplify alignment in spectroscopic instruments.

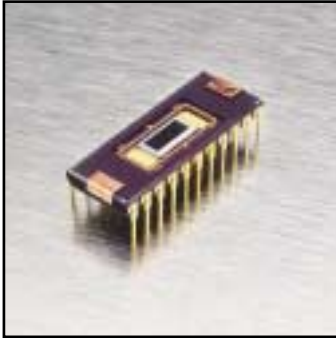

**L-Series Linear CMOS Spectroscopy Sensor—
25 or 50 μm pitch, 2.5 mm aperture**

- 128, 256, 512 or 1024 photodiode elements with 25 μm center-to-center spacing
- 128, 256, or 512 photodiode elements with 50 μm center-to-center spacing

L Series

Technical Specification

Part Number	Video Capacitance		Sensitivity C/J/cm ²	Saturation Exposure nJ/cm ²	Saturation Charge pC	Dynamic Range	Dark Current typ. pA
	@ 5 V bias pF	@ 2.5 V bias pF					
RL1201	—	6.7	2x10 ⁻⁴	50	10	70,000	0.2
RL1202	—	10.2	2x10 ⁻⁴	50	10	70,000	0.2
RL1205	—	15.4	2x10 ⁻⁴	50	10	70,000	0.2
RL1210	—	28.7	2x10 ⁻⁴	50	10	70,000	0.2
RL1501	9.1	—	4x10 ⁻⁴	50	20	100,000	0.4
RL1502	14	—	4x10 ⁻⁴	50	20	100,000	0.4
RL1505	25	—	4x10 ⁻⁴	50	20	100,000	0.4

Sensitivity Exposure/
Saturation Charge:

Measured at 2.5 V video line bias
average 600-700 nm, includes 8% window loss

Dark Current:

Maximum dark current $\leq 1.5 \times$ average dark current

Spectral Response Peak:

650 nm, Range: 300-1000 nm typ.

Operating Temperature:

0°C min. to 55°C max.

Storage Temperature:

-78°C min. to +85°C max.

Center-to-center spacing:

RL12XX, 25 μm
RL15XX, 50 μm

Quantum Efficiency

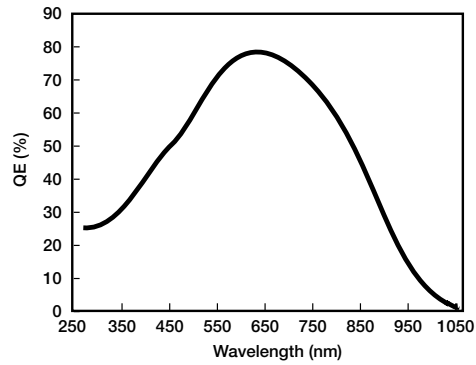

cooled ccd sensors

- **Features**
- 363,000 picture elements (pixels) in a 1100x330 configuration
 - 24 μm square pixels
 - 2-phase buried channel process
 - On-chip amplifier for low noise and high-speed readout
 - Dynamic range greater than 25,000:1
 - On-chip temperature sensor
 - Two-stage TE cooler integrated into the package
 - Hermetically sealed
 - 100% fill factor
 - 10MHz data rate

- **Typical Applications**
- Spectroscopy
 - Fluorescence Microscopy
 - Luminescence
 - Protein Quantification

Datasheet available upon request

Description

The RA1133J is a full-frame CCD sensor with reset capabilities designed specifically for use in spectroscopy, biomedical imaging and related scientific imaging applications. The package for the array is designed with an integrated two-stage thermoelectric cooler. This enables the device to be run 40°C below ambient temperature, -15°C when compared to room temperature. Its combination of very low noise and low dark current make the RA1133J ideal for low-light, high dynamic range, and high-resolution applications.

The imager is structured with a single-output register at one end of the imaging columns. A lateral reset drain is located adjacent to this readout register, which enables the dumping of accumulated charge from the array. Two-phase clocks are needed to drive the readout register, and three-phase clocks are needed to drive imaging cells. The array is available in a 30-pin metal package with an integrated TE cooler.

General Characteristics

Parameter	Symbol	Min.	Typ.	Max.	Units
Format			1100x330		
Pixel Size			24x24		μm
Imaging Area			26.4x7.92		mm
Dynamic Range	DR		25,000:1		
Full Well Charge	Q_{SAT}	250	300		Ke-
Saturation Voltage	V_{SAT}	1000	1200		mV
Dark Current MPP	DL		1	3	pA/cm^2
Photo Response Non Uniformity	PRNU		5	10	$\pm\%$
Dark Signal Uniformity	DSNU		2	5	$\pm\%$
Charge Transfer Efficiency	CTE	>0.9999	>0.99995		
Output Amplifier Gain			4		$\mu\text{V}/\text{e}^-$
Operating Frequency	fclock			10	MHz
Read Noise			10		e-

Dynamic Range: Full well/read noise, MPP mode
 Full Well Charge: RLoad = 5.1 k Ω , MPP mode
 Dark Current MPP: MPP mode at -15°C
 Read Noise: Measured at 500 kHz at -15°C

Absolute Maximum Ratings

Storage Temperature: -55°C min. to 85°C max.
 Operating Temperature: 0°C min. to 55°C max.

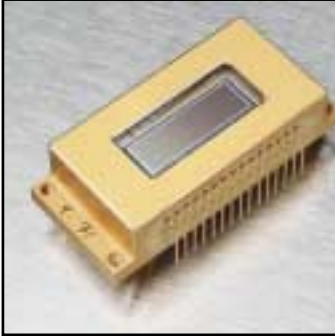

**Cooled CCD Sensor—
24 μm sq. pitch,
1100x330 pixel configuration**

Principle of Operation

A major source of dark current in devices such as these originates in surface states at the Si-SiO₂ interface. A unique design and process enables the RA1133J to be run in “multi-pinned phase” or MPP mode of operation. This helps eliminate dark current generation in the interface surface states. By holding the vertical clocks at negative potential during integration and horizontal signal readout, the surface will not be depleted and the surface state will not generate dark current.

Technical Specification

Part Number	Format	Pixel Size μm	Image Area mm	Saturation Voltage mV typ.	Dark Current MPP pA/cm ²	Dynamic Range	Read Noise
RA1133JAS-912	1100x330	24x24	26.4x7.92	1200	1	>25,000:1	10e-

Dynamic Range: Full well/read noise, MPP mode
 Dark Current MPP: MPP mode at -15°C
 Read Noise: Measured at 500 kHz at -15°C
 Storage Temperature: -55°C min. to +85°C max.
 Operating Temperature: 0°C min. to 55°C max.

Quantum Efficiency

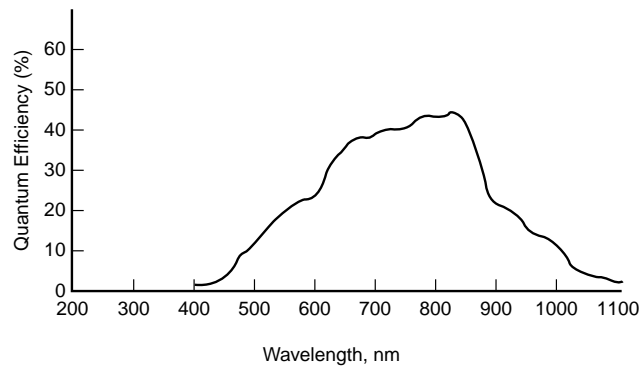

tdi imagers

▶ **PT1109AAQ-711 Features**

- 1024 pixel x 96 stage
- Unidirectional operation
- 20 MHz data rate
- High dynamic range (4300:1)
- Line rates to 19 kHz
- Quantum efficiency of 42% at 700 nm
- 13 μm x 13 μm pixel size
- >0.99995 horizontal, >0.9999 vertical CTE at maximum saturation exposure

▶ **PT1225AAQ-711 Features**

- 2048 pixel x 256 stage
- 64 outputs
- 8 MHz data rate per output
- Unidirectional operation
- High dynamic range of over 66 dB
- Line rates to 256 kHz
- 27 μm x 27 μm pixel size
- >0.99995 horizontal, >0.9999 vertical CTE at maximum saturation exposure

▶ **Typical Applications**

- Semiconductor Inspection
- Wafer Inspection
- Sorting Applications

Datasheets available upon request

Description

The PT1109AAQ and PT1225AAQ Time Delay Integration (TDI) imagers combine the best features of photodiode array detection and TDI operation to offer an uncompromising solution to the increasing demands of high-speed imaging applications.

PT 1109AAQ

The PT1109AAQ is a high-performance TDI imager featuring a unique 13 μm x 13 μm -square TDI pixel architecture. The chip has 96 stages with 1024 pixels per stage, allowing for stable imaging in both fast and low-light applications. Eight extra stages are present at the front end of the sensor, allowing for adequate dark balancing. Full-well capacity of the sensor is 390,000 electrons, and readout noise (rms) is <90 electrons, allowing for a >4300:1 dynamic range.

PT1225AAQ

The PT1225AAQ is a high-performance TDI imager featuring a unique 27 μm x 27 μm -square TDI pixel architecture. The chip has 256 stages with 2048 pixels per stage, allowing for stable imaging in both fast and low-light applications. Full-well capacity of the sensor is 700,000 electrons, and readout noise (rms) is <350 electrons, allowing for a dynamic range of over 66 dB.



TDI Imagers—PT 1109AAQ and PT1225AAQ

Technical Specification

	PT1109AAQ-711	PT1225AAQ-711
Pixel Count*	1024 active elements	2048 active elements
Extra Stages*	8	—
Pixel Size	13x13 μm	27x27 μm
Number of Directions	1	1
Integration Stages**	96	256
Extra Stages**	1	—
Number of Outputs	1	64
Pixel Rate	20 MHz	8 MHz per output
Line Output Rate (max.)	19 kHz	256 kHz
Pixel Fill Factor	100%	100%
Net Quantum Efficiency	>42% at 700 nm	—
Power Dissipation	—	15 mW per tap, 960 mW total
Well Capacity	>390,000 electrons per pixel	>700,000 electrons per pixel
RMS Noise	—	>66 dB
Dynamic Range	—	<350 e- rms
CTE @ Q_{sat}	>0.99995 (horizontal) >0.99999 (vertical)	>0.99995
Photo Response Non-Uniformity (PRNU)	+/-10%	+/-10% within output +/-10% across array
Spectral Response	—	250 to 700 nm
Dark Current	—	<1% of V_{sat}
Sensitivity	3.5 $\mu\text{V}/\text{electron}$	1.0 $\mu\text{V}/\text{electron}$
Operating Temperature	0 to 55°C	0 to 55°C
Package Type	32 pin ceramic	—

Operating Temperature: 0°C min. to 50°C max.

* In readout direction

** In TDI direction

infrared emitting diodes

► Features 880 nm

- Nine standard packages in hermetic and low-cost epoxy
- End- and side-radiating packages
- Graded Output
- High efficiency GaAIAs, 880 nm LPE process Delivers twice the power of conventional GaAs 940 nm emitters

► Features 940 nm

- Three standard packages in hermetic and low-cost epoxy
- End-radiating packages
- High power GaAs, 940 nm LPE process

► Typical Applications

- Computer/Business Equipment
 - Write-Protect Control
 - Margin Controls—Printers
- Industrial
 - LED Light Source—Light Pens
 - Security Systems
 - Safety Shields
- Consumer
 - Coin Counters
 - Lottery Card Readers
 - Position Sensors—Joysticks
 - Remote Controllers—Toys, Appliances, Audio/Visual Equipment
 - Games—Laser Tag
 - Camera Shutter Control

► Principle of Operation

Because they emit at wavelengths which provide a close match to the peak spectral response of silicon photodetectors, both GaAs and GaAIAs IREDS are often used with phototransistors.

Datasheets available upon request

Description

Light Emitting Diodes (LEDs) are solid-state P-N junction devices that emit light when forward biased. An IRED is an Infrared Emitting Diode, a term specifically applied to PerkinElmer IR emitters. Unlike incandescent lamps, which emit light over a very broad range of wavelengths, LEDs emit light over such a narrow bandwidth that they appear to be emitting a single “color”. Their small size, long operating lifetimes, low power consumption, compatibility with solid-state drive circuitry, and relatively low cost make LEDs the preferred light source in many applications.

LEDs are made from a wide range of semiconductor materials. The emitted peak wavelength depends on the semiconductor material chosen and how it is processed. LEDs can be made that emit in the visible or near-infrared part of the spectrum.

The P-N junction is formed by doping one region of the material with donor atoms and the adjacent region with acceptor atoms. Like all P-N junction devices, LEDs exhibit the familiar diode current-voltage characteristics. LEDs emit light only when they are biased in the forward direction. Under forward-biased conditions, carriers are given enough energy to overcome the potential barrier existing at the junction. After crossing the junction, these carriers will recombine. A percentage of the carriers will recombine by a radiative process in which the hole-electron recombination energy is released as a photon of light. The remaining carriers recombine by a non-radiative process and give up their energy in the form of heat. The amount of light generated, or power output of the LED, varies almost linearly with forward current. Doubling the forward current approximately doubles the power output.

880nm IREDS

This series of infrared emitting diodes (IREDS) consists of three standard chips in nine different packages that provide a broad range of mounting, lens and power-output options.

940nm IREDS

This series of infrared emitting diodes (IREDS) consists of two standard chips in three different packages.

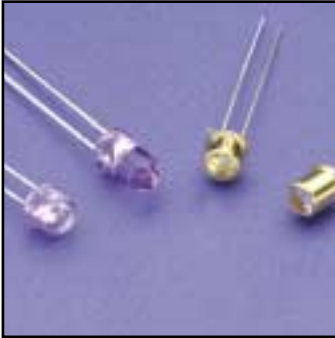

Infrared Emitting Diodes—
VTE Formats 880 nm and 940 nm

**GaAlAs Infrared Emitting Diodes
TO-46 Flat Window Package**

VTE1063

TO-46 Lensed Package

VTE1163

T- 1 3/4 (5 mm) Plastic Package

VTE1261 VTE1281F VTE1291-2
VTE1262 VTE1281W-1 VTE1291W-1
VTE1281-1 VTE1281W-2 VTE1291W-2
VTE1281-2 VTE1291-1

T- 1 3/4 (5 mm) Bullet Package

VTE1285 VTE1295

Long T-1 (3 mm) Plastic Package

VTE3372LA VTE3374LA

Molded Lateral Package

VTE7172 VTE7173

GaAs Infrared Emitting Diodes

TO-46 Flat Window Package

VTE1013

TO-46 Lensed Package

VTE1113

Long T-1 Plastic Package

VTE3322LA VTE3324LA

VTE 880 nm Series

Technical Specification

Part Number	Irradiance E_e mW/cm ²		Irradiance Distance mm	Output Cond. Diameter mm	Radiant Intensity I_e mW/sr min.	Total Power P_0 mW typ.	Test Current I_{FT} mA Pulsed	Forward Drop V_F @ I_{FT} volts		Half Power Beam Angle $\theta_{1/2}$ typ.
	min.	typ.						typ.	max.	
VTE1063	3.8	5	36	6.4	49	80	1	2.8	3.5	±35°
VTE1163	22	28	36	6.4	285	110	1	2.8	3.5	±10°
VTE1261	3	3.9	36	6.4	39	20	100	1.5	2	±10°
VTE1262	4	5.2	36	6.4	52	25	100	1.5	2	±10°
VTE1281-1	2.5	3.3	36	6.4	32	20	100	1.5	2	±10°
VTE1281-2	5	6.5	36	6.4	65	25	100	1.5	2	±10°
VTE1281F	0.16	0.21	36	6.4	2.1	20	100	1.5	2	±45°
VTE1281W-1	1.2	1.6	36	6.4	16	20	100	1.5	2	±25°
VTE1281W-2	2.5	3.3	36	6.4	32	25	100	1.5	2	±25°
VTE1285	3	5.5	36	6.4	39	20	100	1.5	2	±8°
VTE1291-1	2.5	3.3	36	6.4	32	20	100	1.5	2	±12°
VTE1291-2	5	6.5	36	6.4	65	25	100	1.5	2	±12°
VTE1291W-1	1.2	1.6	36	6.4	16	20	100	1.5	2	±25°
VTE1291W-2	2.5	3.3	36	6.4	32	25	100	1.5	2	±25°
VTE1295	3	5.5	36	6.4	39	20	100	1.5	2	±8°
VTE3372LA	2	2.6	10.16	2.1	2	3	20	1.3	1.8	±10°
VTE3374LA	4	5.2	10.16	2.1	4.1	5	20	1.3	1.8	±10°
VTE7172	0.4	0.6	16.7	4.6	1.1	2.5	20	1.3	1.8	±25°
VTE7173	0.6	0.8	16.7	4.6	1.7	5	20	1.3	1.8	±25°

Electro-Optical Characteristics @ 25°C

VTE 940 nm Series

Technical Specification

Part Number	Irradiance E_e mW/cm ²		Irradiance Distance mm	Output Cond. Diameter mm	Radiant Intensity I_e mW/sr min.	Total Power P_0 mW typ.	Test Current I_{FT} mA Pulsed	Forward Drop V_F @ I_{FT} volts		Half Power Beam Angle $\theta_{1/2}$ typ.
	min.	typ.						typ.	max.	
VTE1013	2.1	2.7	36	6.4	27	30	1	1.9	2.5	±35°
VTE1113	12	15	36	6.4	156	30	1	1.9	2.5	±10°
VTE3322LA	1	1.3	10.16	2.1	1	1.5	20	1.25	1.6	±10°
VTE3324LA	2	2.6	10.16	2.1	2	2.5	20	1.25	1.6	±10°

Electro-Optical Characteristics @ 25°C

laser diodes

- **Typical Applications**
- Laser Range Finding
 - LIDAR
 - Optical Fusing
 - High Speed Switching
 - Weapons Simulation
 - Laser Scanning
 - Fiber Optic Instrumentation
 - YAG Laser Simulation

Description

Pulsed Laser Diodes

These devices range in wavelength from 850 nm to 1550 nm and are produced using Vapor Phase Epitaxial (VPE) and MOCVD growth techniques. Fiber optic pigtailed devices employ an advanced fibre alignment process yielding highly stable fiber to laser diode positioning. Alternative packages and fiber optic core diameters may be supplied on a custom basis.

High Energy Laser Diodes—Quasi CW Lasers

These devices have been designed specifically to meet the demanding requirements of laser initiated ordnance (LIO) applications. Product offerings include a 9.0 mm TO-style package and an 8 pin miniDIL pigtailed package equipped with a rear facet monitor photodiode and 100/140 μm optical fiber. The 980 nm laser chip employs advanced epitaxial materials and processing techniques, providing reliable high optical power output capability and significant power retention at elevated temperatures. Alternate package outlines and fiber optic core diameters may be considered on a custom basis.

Multiple Quantum Well Types—850 nm

Technical Specification								
Part Number	Preferred Package	Peak Output Power P_{ko} (W)	Peak Forward Current I_f (A)	Pulse Width t_w (ns)	Maximum Duty Factor DF (%)	Response Time t_r (ns)	Beam Diverg. $\theta \times \theta^{\wedge}$ (deg.) FWHM	Number of Diode Elements
PFAS1S03	TO-52	5.5	7	50	0.025	<1	12x30	1
PFAS1S09	TO-52	17	20	50	0.025	<1	12x30	1
PFAS1S12	TO-52	26	30	50	0.025	<1	12x30	1
PFAS1S16	TO-52	34	40	50	0.025	<1	12x30	1
PFAS2S09	TO-52	34	20	50	0.025	<1	12x30	2
PFAS2S12	TO-52	52	30	50	0.025	<1	12x30	2
PFAS3S12	TO-52	78	30	50	0.025	<1	12x30	3

Test conditions: T = 22°C

Multiple Quantum Well Types—905 nm—PGA Series

Technical Specification								
Part Number	Preferred Package	Peak Output Power P_{ko} (W)	Peak Forward Current I_f (A)	Pulse Width t_w (ns)	Maximum Duty Factor DF (%)	Response Time t_r (ns)	Beam Diverg. $\theta \times \theta^{\wedge}$ (deg.)	Number of Diode Elements
PGAS1S03	TO-52	5.5	7	150	0.01	<1	10x25	1
PGAS1S06	TO-52	12	15	150	0.01	<1	10x25	1
PGAS1S09	TO-52	18	22	150	0.01	<1	10x25	1
PGAS1S12	TO-52	24	30	150	0.01	<1	10x25	1
PGAS1S16	TO-52	33	40	150	0.01	<1	10x25	1
PGAS1S24	TO-52	49	60	150	0.01	<1	10x25	1
PGAS3S06	TO-52	34	15	150	0.01	<1	10x30	3
PGAS3S09	TO-52	50	22	150	0.01	<1	10x30	3
PGAS3S12	TO-52	67	30	150	0.01	<1	10x30	3
PGAS4S12	TO-52	90	30	150	0.01	<1	10x30	4
PGAS4S16	TO-52	120	40	150	0.01	<1	10x30	4

Test conditions: T = 22°C

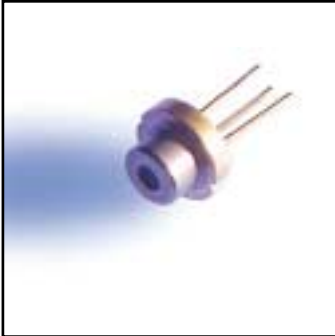

Laser Diodes

Multiple Quantum Well Types–905 nm–PGEW Series

Technical Specification

Part Number	Standard Package	Peak Output Power P _{ko} (W)	Peak Forward Current I _F (A)	Pulse Width t _w (ns)	Maximum Duty Factor DF (%)	Beam Diverg. Q ^x Q ^y (deg.)	Number of Diode Elements
PGEW1S03	TO-52 plastic	5	7	30	0.0075	10x25	1
PGEW1S09	TO-52 plastic	15	25	30	0.0075	10x25	1
PGEW2S09	TO-52 plastic	33	25	30	0.0075	10x30	2
PGEW3S09	TO-52 plastic	50	25	30	0.0075	10x30	3

Test conditions: T = 22°C



Laser Diodes

Double Heterostructure Types–1550 nm

Technical Specification

Part Number	Standard Package	Peak Output Power P _{ko} (W)	Peak Forward Current I _F (A)	Pulse Width t _w (ns)	Maximum Duty Factor DF (%)	Response Time t _r (ns)	Beam Diverg. Q ^x Q ^y (deg.) FWHM	Number of Diode Elements
PVGR1S06	CD9.0CAP	4	20	200	0.1	<1	20x40	1
PVGS1S06	TO-52	4	20	200	0.1	<1	20x40	1
PVGR2S06	CD9.0CAP	8	20	100	0.1	<1	20x40	2
PVGS2S06	TO-52	8	20	100	0.1	<1	20x40	2
PVGR4S12	CD9.0CAP	40	75	50	.025	<1	20x40	4

Test conditions: T = 22°C

Quantum Well Types–980 nm

Technical Specification

Part Number	Standard Package	Peak Output Power P _{ko} (W)	Peak Forward Current I _F (A)	Pulse Width t _w (ns)	Maximum Duty Factor DF (%)	Response Time t _r (ns)	Beam Diverg. Q ^x Q ^y (deg.) FWHM	Fibre Optic Core/Clad Diam. (µm)
C86118E	CD9.0CAP	1.5	2	10	10	<1	10x35	—
C86155E-10	miniDIL	1.2	2	10	10	<1	—	100/140
C86159E-09	miniDIL	2	4	10	10	<1	—	200/240

Test conditions: T = 22°C

Double Heterostructure and Quantum Well Types–850 nm and 1064 nm

Technical Specification

Part Number	Standard Package	Centre Wavelength λ ₀ (nm)	Peak Output Power P _{ko} (W)	Peak Forward Current I _F (A)	Pulse Width t _w (ns)	Maximum Duty Factor DF (%)	Beam Diverg. Q ^x Q ^y (deg.) FWHM	Fibre Optic Core/Clad Diam. (µm)
C86153E-12	14 pin DIL	850	0.75	5	200	0.1	—	62.5/125
C86119E	10/32 COAX	1064	2	4	200	0.1	10x40	—
C86120E-10	14 pin DIL	1064	0.4	4	200	0.1	—	100/140

Test conditions: T = 22°C

medical sensors



Features

- Meets ASTM standards for capnometers
- Neonatal, Pediatric and Adult use
- Low-flow design
- Fast rise time for high respiration rates
- Compatible with standard sampling disposables
- Easy-to-interface RS232 Digital Output
- Rugged solid-state sensor—no moving parts
- Low power consumption
- Fast warm-up time
- Long life
- Small footprint
- Custom packaging available



Typical Applications

Real-time breath-to-breath quantitative end-tidal CO₂ measurement

Datasheets available upon request

Digital Sidestream CO₂ Bench

The PerkinElmer Digital Sidestream CO₂ Bench represents a breakthrough in solid-state technology. These sensors achieve the highest levels of accuracy and reliability while having no moving parts. The low power consumption and compact design set a new standard in sidestream monitoring. The bench incorporates our latest advances in component design and signal processing.

All design requirements of ASTM standards have been met or exceeded. The measurement technique is non-dispersive infrared absorption, which utilizes a unique infrared emitter design in conjunction with state-of-the-art detector technology. Output from the bench is a digitized voltage function of CO₂ concentration within the sampling cell. The sidestream sensor is on a printed circuit board with an RS232 connector, has added pneumatics circuit, and uses standard sampling disposables.

Digital Mainstream CO₂ Sensor

PerkinElmer introduces a significant advancement in mainstream CO₂ sensing. Output from the sensor is a digitized voltage function of CO₂ concentration, providing a noise-free signal and easy interfacing. All processing electronics are self-contained within the compact and rugged sensor head. The solid-state design incorporates our latest advances in component innovation and signal processing, and ensures high accuracy and long life.

All design requirements of ASTM standards have been met or exceeded. The measurement technique is non-dispersive infrared absorption, which utilizes a unique infrared emitter design in conjunction with state-of-the-art detector technology. This sensor has self-contained electronics on a flex circuit, a cable, and uses low-cost disposable airway adapters.



CO₂ Sidestream Sensors

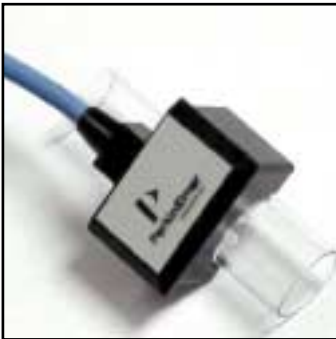

Mainstream CO₂ Sensors

Technical Specification

	Digital Sidestream CO ₂ Bench	Digital Mainstream CO ₂ Sensor
Method	Non-dispersive Infrared Absorption	Non-dispersive Infrared Absorption
Calibration	3-point calibration	3-point calibration
Respiration Rate	150 bpm	150 bpm
Input Voltage	5 V	5 V
Power Consumption	1.0 W typical, 1.5 W max	1.0 W typical, 1.5 W max
Output	Digital Serial RS232	Digital Serial RS232
Measurement Range	0-100 mmHg	0-100 mmHg
Accuracy	±2 mmHg plus ± 5% of reading meets ASTM standards to 100mmHg	±2 mmHg ±5% from 0 to 10% meets ASTM standards to 100mmHg
Resolution	1 mmHg	1 mmHg
Rise Time	Less than 250 ms	Less than 200 ms
Flow Rate	50 ml/min ± 10 ml/min	N/A
Warm-up Time	≤ 1 minute to ASTM Standards ≤5 minutes to published specifications	≤ 1 minute to ASTM Standards ≤5 minutes to published specifications
Mechanical Shock	100 G 1/2 sine wave	100 G 1/2 sine wave
Temperature	0-50°C (operating) -40-75°C (storage)	0-40°C (operating at published specifications) 0-50°C (operating at ASTM Standards) -40-75°C (storage)
Relative Humidity	15-95% non-condensing (operating) 10-95% non-condensing (storage)	15-95% non-condensing (operating) 10-95% non-condensing (storage)
Physical Dimensions	2.5x1.5x0.75"	1.38x1.06x0.88"
Cable	N/A	10-foot standard length
Connector	DB-9 or custom	Standard or custom



Corporate Headquarters: PerkinElmer Optoelectronics, 44370 Christy Street, Fremont, CA 94538-3180
P: (510) 979-6500, (800) 775-6786, **F:** (510) 687-1140
www.optoelectronics.perkinelmer.com