

IEC Appliance Inlet C14 with Line Switch 2-pole, Fuseholder 1- or 2-pole



Order required accessories separately



Approvals and Compliances

Description

- Panel Mount :  
Screw-on version from front or rear side
- 3 Functions :  
Appliance Inlet Protection class I , Line Switch 2-pole , Fuseholder for fuse-links 5 x 20 mm 1- or 2-pole
- V-Lock notch standard
- Meets the requirements of IEC 60335-1 for appliances in unattended use. This includes the enhanced requirements of glow wire tests acc. to IEC 60695-2-12 and -13.
- Quick connect terminals 4.8 x 0.8 mm

Characteristics

- Ultra-compact design. Ideal for low profile designs
- All single elements are already wired
- Fuse drawer meets requirements of medical standard IEC/EN 60601-1
- Ideal for application with high transient loads
- Suitable for use in equipment according to IEC/UL 60950

Other versions on request

- Solder terminals
- Fuse drawer 1-pole, plus spare fuse case
- Fuse drawer 2-pole, with shorting bar
- Other rocker marking
- Line switch 1-pole
- Protection class II, 70°C

References

- Alternative: version with line filter [DD12](#); [DD14](#)
- Alternative: version for snap-in mounting [KM](#)
- Alternative: version for PCB mounting [DD21](#)

Weblinks

[pdf datasheet](#), [html-datasheet](#), [General Product Information](#), [Distributor-Stock-Check](#), [Accessories](#), [Detailed request for product](#), [Microsite](#)

Technical Data

Ratings IEC	10A / 250VAC; 50Hz
Ratings UL/CSA	8A / 250VAC; 60Hz <sup>1)</sup>
Dielectric Strength	> 2.5 kVAC between L-N > 3 kVAC between L/N-PE (1 min/50Hz)
Allowable Operation Temperature	-25 °C to 85 °C
IP-Protection	from front side IP 40 acc. to IEC 60529
Insulation cover	Suitable for appliances with protection class I acc. to IEC 61140
Terminal	Quick connect terminals 4.8 x 0.8 mm
Panel Thickness S	Screw-on mounting: max 8mm Mounting screw torque max 0.5Nm Rear side mounting: max 2 mm
Material: Housing	Thermoplastic, black, UL 94V-0

appliance inlet/-outlet	C14 acc. to IEC 60320-1 UL 498, CSA C22.2 no. 42 (for cold conditions) pin-temperature 70 °C, 10A, Protection Class I
Fuseholder	1 or 2 pole, Shocksafe category PC2 acc. to IEC 60127-6, for fuse-links 5 x 20mm
Rated Power Acceptance @ Ta 23 °C	5 x 20: 2W (1 pole)/ 1.6W (2-pole) per pole
Power Acceptance @ Ta > 23°C	Admissible power acceptance at higher ambient temperature see derating curves
Line Switch	Rocker switch 2-pole, non-illuminated or illuminated, acc. to IEC 61058-1 <a href="#">Technical Details</a>

<sup>1)</sup> with cover 7 A, without cover 8 A



Approvals and Compliances

Detailed information on product approvals, code requirements, usage instructions and detailed test conditions can be looked up in [Details about Approvals](#)

## Approvals





The approval mark is used by the testing authorities to certify compliance with the safety requirements placed on electronic products.

Approval Reference Type: DD11

Approval Logo	Certificates	Certification Body	Description
	VDE Approvals	VDE	Certificate Number: 40018283
	UL Approvals	UL	UL File Number: E93617

## Product standards

Product standards that are referenced

Organization	Design	Standard	Description
	Designed according to	IEC 60320-1	Appliance couplers for household and similar general purposes
	Designed according to	IEC 60127-6	Miniature fuses. Part 6. Fuse-holders for miniature fuse-links
	Designed according to	IEC 61058-1	Switches for appliances. Part 1. General requirements
	Designed according to	UL 498	Standard for Attachment Plugs and Receptacles
	Designed according to	CSA C22.2 no. 42	General Use Receptacles, Attachment Plugs, and Similar Wiring Devices







## Application standards

Application standards where the product can be used

Organization	Design	Standard	Description
	Designed for applications acc.	IEC/UL 60950	IEC 60950-1 includes the basic requirements for the safety of information technology equipment.
	Designed for applications acc.	IEC 60601-1	Medical electrical equipment - Part 1: General requirements for basic safety and essential performance
	Designed for applications acc.	IEC 60335-1	Safety of electrical appliances for household and similar purposes. Meets the requirements for appliances in unattended use. This includes the enhanced requirements of glow wire tests acc. to IEC 60695-2-12 and -13.

## Compliances

The product complies with following Guide Lines

Identification	Details	Initiator	Description
	CE declaration of conformity	SCHURTER AG	The CE marking declares that the product complies with the applicable requirements laid down in the harmonisation of Community legislation on its affixing in accordance with EU Regulation 765/2008.
	RoHS	SCHURTER AG	EU Directive RoHS 2011/65/EU
	China RoHS	SCHURTER AG	The law SJ / T 11363-2006 (China RoHS) has been in force since 1 March 2007. It is similar to the EU directive RoHS.
	REACH	SCHURTER AG	On 1 June 2007, Regulation (EC) No 1907/2006 on the Registration, Evaluation, Authorization and Restriction of Chemicals 1 (abbreviated as "REACH") entered into force.
	MicrositeV-Lock	SCHURTER AG	V-Lock system are based on a matching plug-dose combination. The connector is equipped with a notch intended for use with the latching cordset. The cord latching system prevents against accidental removal of the cordset.
	Medical Equipment	SCHURTER AG	Suitable for use in medical equipment according to IEC/UL 60601-1

**Dimensions [mm]**

Screw version

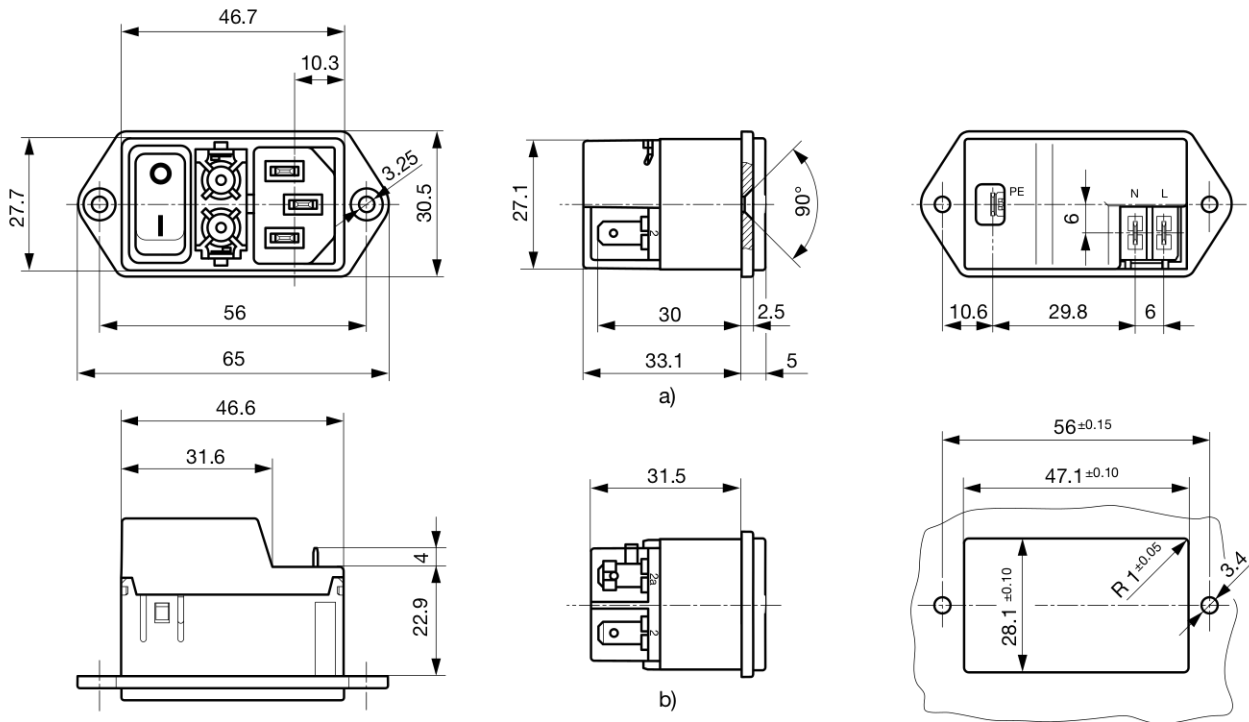

a) view with cover  
 b) view without cover

**Diagrams**

non-illuminated

illuminated

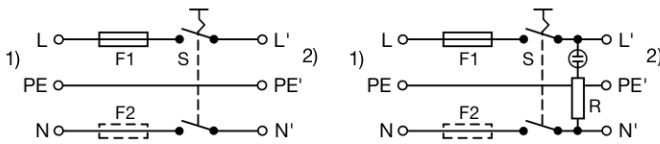

1) Line  
 2) Load

1) Line  
 2) Load

**Derating Curves**

1-pole

2-pole

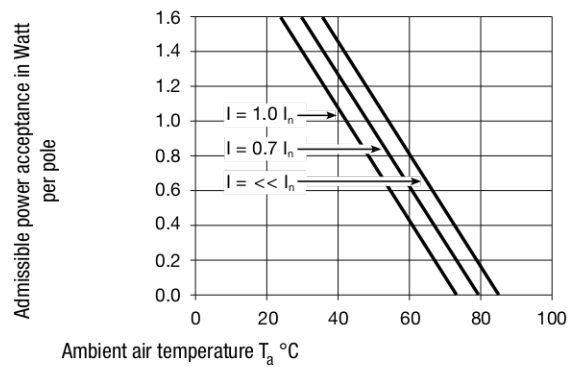
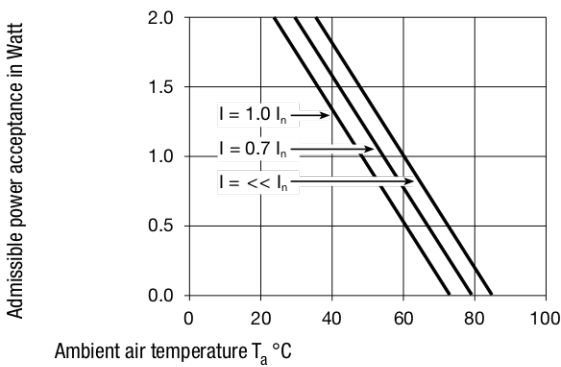

## All Variants

Fuseholder	Line Switch	Illumination	Color	Cover <sup>1)</sup>	V-Lock	Order Number
1-pole	2-pole	non-illuminated	-		●	DD11.0111.1110
1-pole	2-pole	illuminated	red		●	DD11.0113.1110
1-pole	2-pole	illuminated	green		●	DD11.0114.1110
2-pole	2-pole	non-illuminated	-		●	DD11.0121.1110
2-pole	2-pole	illuminated	red		●	DD11.0123.1110
2-pole	2-pole	illuminated	green		●	DD11.0124.1110
1-pole	2-pole	non-illuminated	-	●	●	DD11.0111.1111
1-pole	2-pole	illuminated	red	●	●	DD11.0113.1111
1-pole	2-pole	illuminated	green	●	●	DD11.0114.1111
2-pole	2-pole	non-illuminated	-	●	●	DD11.0121.1111
2-pole	2-pole	illuminated	red	●	●	DD11.0123.1111
2-pole	2-pole	illuminated	green	●	●	DD11.0124.1111

<sup>1)</sup> current rating UL: with cover 7 A, without cover 8 A

Most Popular.



Availability for all products can be searched real-time: <https://www.schurter.com/en/Stock-Check/Stock-Check-SCHURTER>

Packaging unit 50 Pcs

## Required Accessory

Description	
	<b>Fusedrawer 2</b> Fusedrawer für Fuse Links 5x20 mm, with or without Voltage Selector Insert
	Fingergrip, 2-pole 4301.1401
	Extra-Safe, 2-pole 4301.1403
	Fingergrip, 1-pole 4301.1405
	Extra-Safe, 1-pole 4301.1407
...	

## Accessories

	<b>Wire Harness</b> Wire harness for SCHURTER products
	<b>Cord retaining kits</b> Cord retaining strain relief
	Flat head, A 4700.0001

**Mating Outlets/Connectors**

**Category / Description**



[Appliance Outlet Overview complete](#)

IEC Appliance Outlet F, Screw-on Mounting, Front Side, Solder Terminal	4787
IEC Appliance Outlet F, Snap-in Mounting, Front Side, Solder or Quick-connect Terminal	4788
IEC Appliance Outlet F or H, Screw-on Mounting, Front Side, Solder, PCB or Quick-connect Terminal	5091

[Appliance Outlet further types to DD11](#)

[Connector Overview complete](#)



4782 Mounting: Power Cord, 3 x 1 mm² / 3 x 18 AWG, Cable, Connector: IEC C13	4782
4022 Mounting: Power Supply Cord, 3 x 1.5 mm², Screw clamps, Connector: IEC C13	4022
4785 Mounting: Power Cord, 3 x 1 mm² / 3 x 18 AWG, Cable, Connector: IEC C13	4785
4300-06 Mounting: Power Cord, 3 x 1 mm² / 3 x 18 AWG, Cable, Connector: IEC C13	4300-06
4012 Mounting: Power Supply Cord, 3 x 1.5 mm², Screw clamps, Connector: IEC C13	4012

[Connector further types to DD11](#) ...

**Mating Outlets/Connectors shuttered**



[Power Cord Overview complete](#)

VAC13KS, Overview, diverse Connector IEC C13, cord end:	VAC13KS
Power cord with IEC connector C17, V-Lock, straight	VAC17KS

[Power Cord further types to DD11](#)