

Frontpanel Switch / Momentary Action, Medium Stroke, 10 mm



See below:
[Approvals and Compliances](#)

Description

- Available in version square or round in different colours
- non-illuminated or illuminated
- 1- or 2-pole Frontpanel and PCB Mounting
- Solder, THT or solder lugs

Unique Selling Proposition

- Absolute reliability and simple assembly
- Compact design with very small mounting depth
- Good illumination

Weblinks

[html-datasheet](#), [General Product Information](#), [CAD-Drawings](#), [Product News](#), [Detailed request for product](#)

Technical Data

Electrical Data

| | |
|-----------------------|--|
| Switching Voltage | min. 100 mVAC/DC , max. 48 VAC / 48 VDC |
| Switching Current | max. 200 mA |
| Lifetime | > 100'000 actuations at Rated Switching Capacity 1.2 W |
| Contact Resistance | < 20 mΩ < 25 mΩ after lifetime |
| Insulation Resistance | > 10'000 MΩ |
| Duration of Bounce | typ. 0.5 ms |

Mechanical Data

| | |
|----------------------|----------------------|
| Actuating Force | 1.2 ± 0.6 N |
| Actuating Travel | 1.3 ± 0.5 mm |
| End Actuating Travel | 2.9 ± 0.5 mm |
| End Stop Strength | > 50 N |
| Lifetime | > 100'000 actuations |

Climatical Data

| | |
|-----------------------|---------------------------------|
| Operating Temperature | illuminated -25 °C to 60 °C |
| | non-illuminated -25 °C to 85 °C |
| Storage Temperature | illuminated -25 °C to 60 °C |
| | non-illuminated -25 °C to 85 °C |
| IP-Protection | IP 40 |

Other Data

| | |
|------------------------------|---|
| Solderability | 235 °C / 2 sec (IEC 60068-2-20 Test Ta Method 1) |
| Resistance to Soldering Heat | 260 °C / 5 sec (IEC 60068-2-20 Test Tb Method 1A) |

Material

| | |
|----------------|----------------------|
| Socket | Thermoplastic (PES) |
| Button | Thermoplastic (PC) |
| Contact | CuZn37 5 µm Ag |
| Contact spring | CuBe37 5 µm Ag |
| Terminals | CuZn37 4 µm SN Pb 40 |

Approvals and Compliances

Detailed information on product approvals, code requirements, usage instructions and detailed test conditions can be looked up in [Details about Approvals](#)



Application standards

Application standards where the product can be used

| Organization | Design | Standard | Description |
|--------------|--------------------------------|--------------|---|
| | Designed for applications acc. | IEC/UL 60950 | IEC 60950-1 includes the basic requirements for the safety of information technology equipment. |

Compliances

The product complies with following Guide Lines

| Identification | Details | Initiator | Description |
|--|------------|-------------|---|
|  | RoHS | SCHURTER AG | EU Directive RoHS 2011/65/EU |
|  | China RoHS | SCHURTER AG | The law SJ / T 11363-2006 (China RoHS) has been in force since 1 March 2007. It is similar to the EU directive RoHS. |
|  | REACH | SCHURTER AG | On 1 June 2007, Regulation (EC) No 1907/2006 on the Registration, Evaluation, Authorization and Restriction of Chemicals 1 (abbreviated as "REACH") entered into force. |

Dimension [mm]

Small button

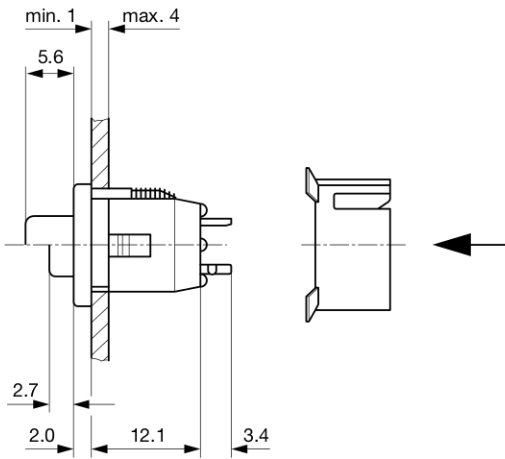

Small button with solder lugs

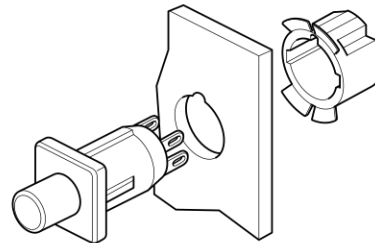
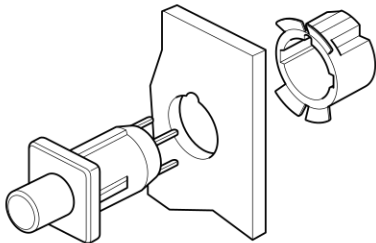
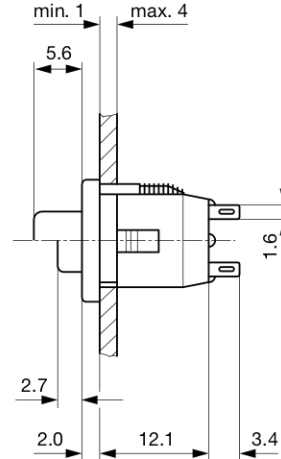

Small button

Small button with solder lugs

Dimension

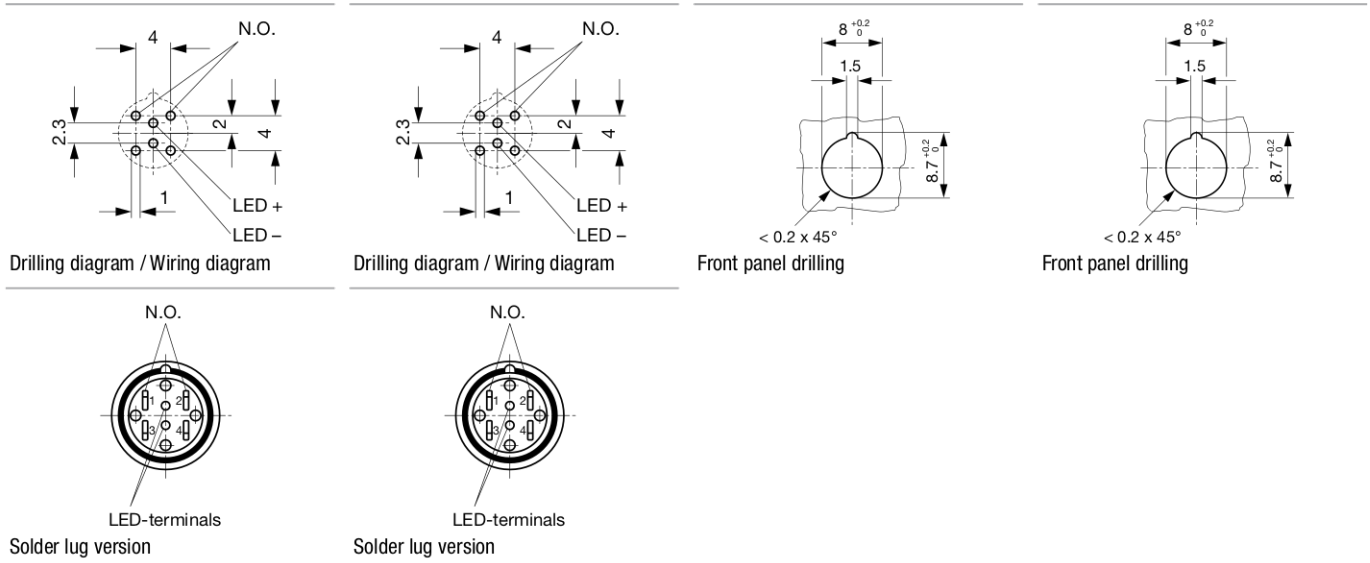

Assembly Instructions

Securing clip, round bezel button, square bezel button

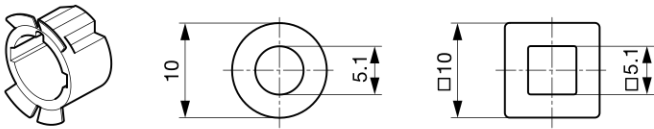

Necessary for front panel mounting

Diagrams

NO 1 pole

NO 2 pole



All Variants

| Type | Number of Poles | Terminal | Form | Illumination | Color Button | Color LED | Color Bezel | Securing clip ¹⁾ | Bestellnummer |
|-------------------------|-----------------|-------------|-------|--------------|--------------|-----------|-------------|-----------------------------|----------------|
| Momentary Action Switch | 1-pole | Solder lugs | round | | red | - | black | ● | 0041.8841.3107 |
| Momentary Action Switch | 1-pole | Solder lugs | round | | black | - | black | ● | 0041.8841.7107 |
| Switches | 2-pole | Solder lugs | round | ● | red | red | black | ● | 0041.8857.3117 |
| Switches | 2-pole | Solder lugs | round | ● | green | green | black | ● | 0041.8857.5127 |
| Momentary Action Switch | 1-pole | Solder, THT | round | | red | - | black | | 0041.9141.3107 |

| Type | Number of Poles | Terminal | Form | Illumination | Color Button | Color LED | Color Bezel | Securing clip ¹⁾ | Bestellnummer |
|-------------------------|-----------------|-------------|-------|--------------|--------------|-----------|-------------|-----------------------------|----------------|
| Momentary Action Switch | 1-pole | Solder, THT | round | ● | red | red | black | | 0041.9146.3117 |
| Momentary Action Switch | 1-pole | Solder, THT | round | ● | green | green | black | | 0041.9146.5127 |
| Switches | 1-pole | Solder, THT | round | ● | red | red | black | | 0041.9156.3117 |
| Switches | 1-pole | Solder, THT | round | ● | green | green | black | | 0041.9156.5127 |
| Securing clip | - | - | - | | - | - | - | | 0850.9242 |

With the illuminated version, the small button is transparent

¹⁾Securing clip is included for solder lug version

■ Most Popular.

Availability for all products can be searched real-time:<https://www.schurter.com/en/Stock-Check/Stock-Check-SCHURTER>

Packaging unit 100 pcs