

## 50 A, 1000 V SCR thyristor in RD91

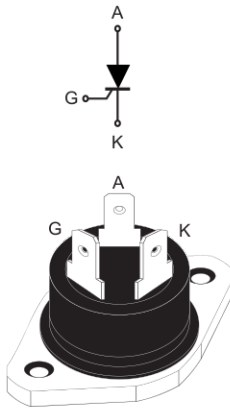

RD91

## Features

- High current SCR
- High commutation capability
- Low thermal resistance with clip bonding
- Insulated package RD91 high power:
  - Low thermal resistance with clip bonding
  - Insulated voltage: 2500 V<sub>RMS</sub>
  - Complies with UL 1557 (File ref : E81734)
- RoHS (2002/95/EC) compliant

## Applications

- Solid state relays
- Welding equipment
- High power motor control

## Description

Available in 2500 V insulated high power package, the 50 A and 1000 V SCR BTW67 is suitable in applications where power handling and power dissipation are critical, such as solid state relays, welding equipment and high power motor control.

Based on a clip assembly technology, they offer a superior performance in surge current handling capabilities.

## Product status link

[BTW67](#)

## Product summary

$I_{T(RMS)}$	50 A
$V_{DRM}/V_{RRM}$	1000 V
$I_{GT}$	80 mA

# 1 Characteristics

**Table 1. Absolute maximum ratings**

Symbol	Parameters		Value	Unit	
$I_{T(RMS)}$	RMS on-state current (full sine wave)		$T_C = 70\text{ °C}$	50	A
$I_{T(AV)}$	Average on-state current (180° conduction angle)		$T_C = 70\text{ °C}$	32	A
$I_{TSM}$	Non repetitive surge peak on-state current (full cycle, $T_j$ initial = 25 °C)		$t_p = 8.3\text{ ms}$	610	A
$I^2t$	$I^2t$ value for fusing	$t_p = 10\text{ ms}$		1680	A <sup>2</sup> s
$di/dt$	Critical rate of rise of on-state current $I_G = 2 \times I_{GT}$ , $t_r \leq 100\text{ ns}$	$F = 60\text{ Hz}$	$T_j = 125\text{ °C}$	50	A/ $\mu$ s
$I_{GM}$	Peak gate current	$t_p = 20\text{ }\mu$ s	$T_j = 125\text{ °C}$	8	A
$P_{G(AV)}$	Average gate power dissipation		$T_j = 125\text{ °C}$	1	W
$T_{stg}$	Storage junction temperature range			-40 to +150	°C
$T_j$	Operating junction temperature range			-40 to +125	°C
$V_{GRM}$	Maximum peak reverse gate voltage			5	V
$V_{ins}$	Insulation RMS voltage, 1 minute			2500	V

**Table 2. Electrical characteristics ( $T_j = 25\text{ °C}$ , unless otherwise specified)**

Symbol	Test conditions	$T_j$		Value	Unit
$I_{GT}$	$V_D = 12\text{ V}$ , $R_L = 33\text{ }\Omega$	25 °C	Min.	8	mA
			Max	80	
$V_{GT}$			Max	1.3	V
$V_{GD}$	$V_D = V_{DRM}$ , $R_L = 3.3\text{ k}\Omega$	125 °C	Min.	0.2	V
$I_H$	$I_T = 500\text{ mA}$ , gate open		Max.	150	mA
$I_L$	$I_G = 1.2 \times I_{GT}$		Max.	200	mA
$dV/dt$	$V_D = 67\%$ , $V_{DRM}$ gate open	125 °C	Min.	1000	V/ $\mu$ s
$V_{TM}$	$I_{TM} = 100\text{ A}$ , $t_p = 380\text{ }\mu$ s	25 °C	Max.	1.9	V
$V_{TO}$	threshold on-state voltage	125 °C	Max.	1.0	V
$R_D$	Dynamic resistance	125 °C	Max.	8.5	m $\Omega$
$I_{DRM}/I_{RRM}$	$V_D = V_{DRM}$ , $V_R = V_{RRM}$	25 °C	Max.	10	$\mu$ A
		125 °C		5	mA

**Table 3. Thermal resistance**

Symbol	Parameters	Value	Unit
$R_{th(j-c)}$	Junction to case (D.C)	1.0	°C/W

## 1.1 Characteristics curves

**Figure 1. Maximum average power dissipation versus average on-state current**

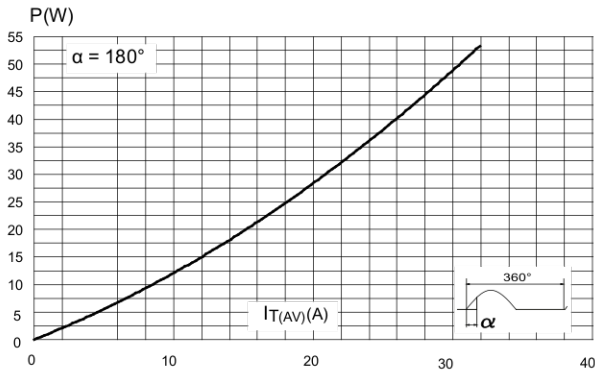

**Figure 2. Average on-state current versus case temperature**

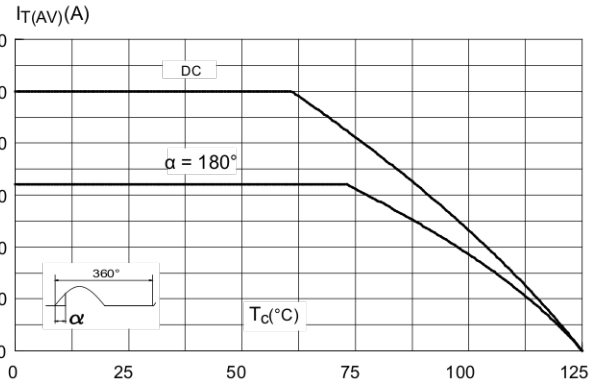

**Figure 3. Relative variation of thermal impedance versus pulse duration**

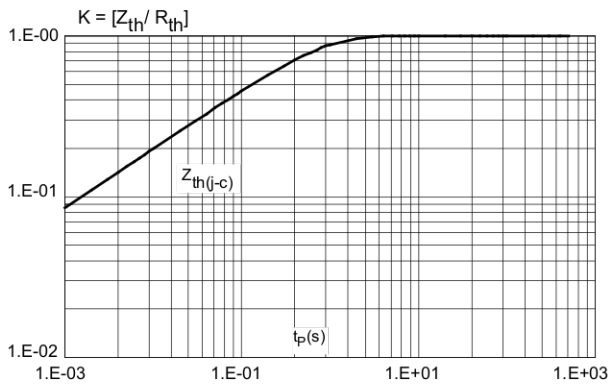

**Figure 4. Relative variation of gate trigger current, holding current and latching current versus junction temperature**

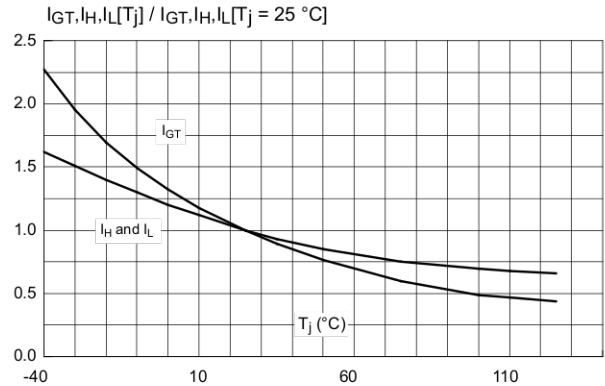

**Figure 5. Surge peak on-state current versus number of cycles**

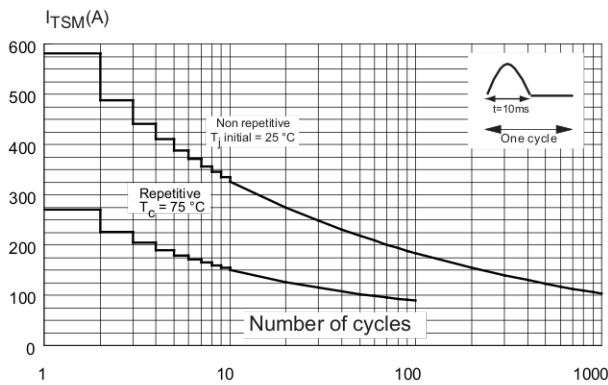

**Figure 6. Non repetitive surge peak on-state current for a sinusoidal pulse with width  $t_p < 10\text{ms}$ , and corresponding value of  $I^2t$**

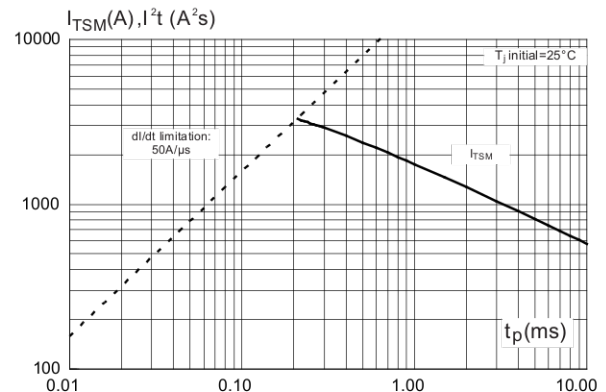
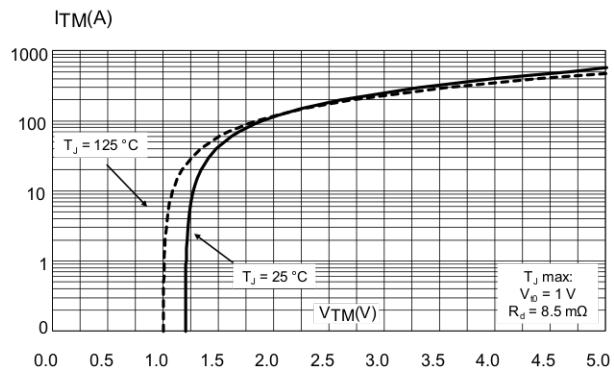

Figure 7. On-state characteristics (maximum values)



## 2 Package information

In order to meet environmental requirements, ST offers these devices in different grades of **ECOPACK** packages, depending on their level of environmental compliance. ECOPACK specifications, grade definitions and product status are available at: [www.st.com](http://www.st.com). ECOPACK is an ST trademark.

### 2.1 RD91 package information

- Epoxy meets UL94, V0
- Cooling method: Conduction
- Recommended torque: 0.9 to 1.2 N·m

**Figure 8. RD91 package outline**

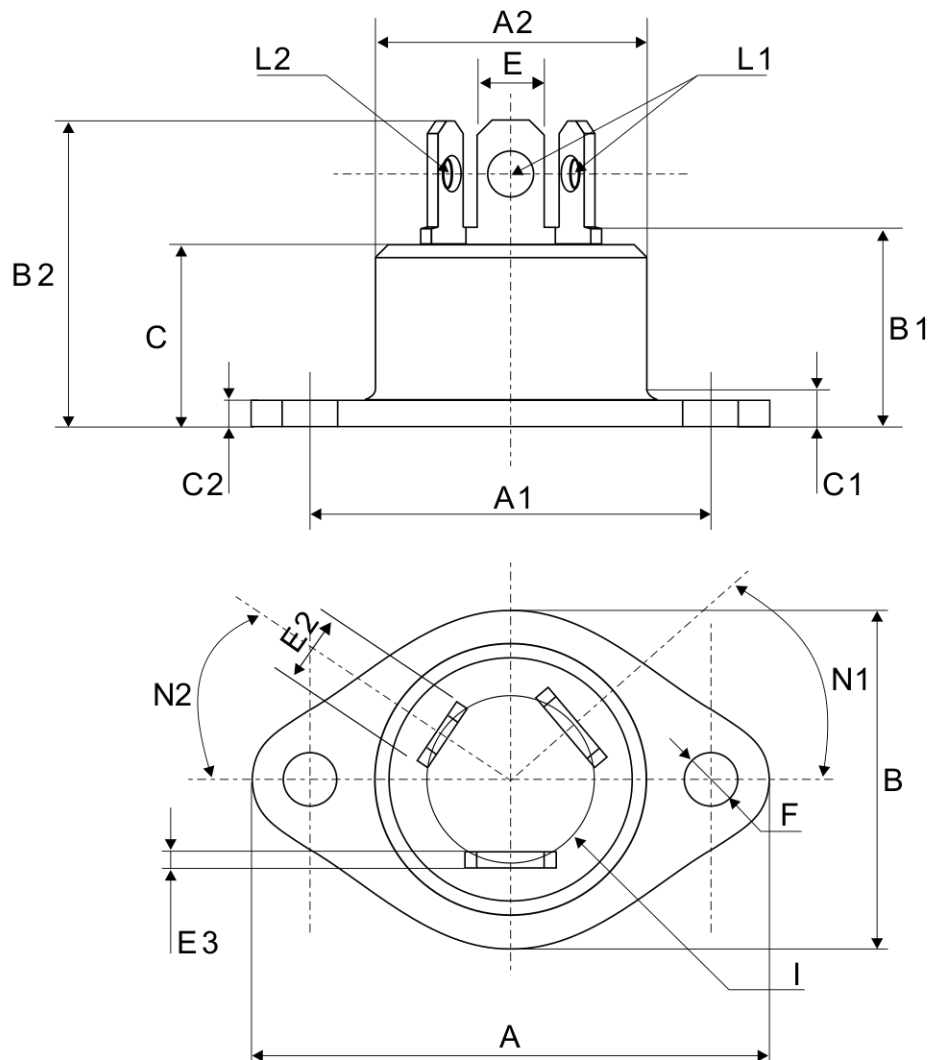

**Table 4. RD91 mechanical data**

Ref.	Dimensions					
	mm			Inches <sup>(1)</sup>		
	Min.	Typ.	Max.	Min.	Typ.	Max.
A			40.00			1.575
A1	30.10		30.30	1.185		1.193
A2			22.00			0.867
B			27.00			1.063
B1	13.50		16.50	0.531		0.650
B2			24.00			0.945
C			14.00			0.552
C1			3.50			0.138
C2	1.90		2.10	0.074		0.083
E	6.10		6.50	0.240		0.256
E2	4.80		5.20	0.188		0.205
E3	0.70		0.90	0.027		0.036
F	4.00		4.30	0.157		0.170
I	11.20		11.60	0.440		0.536
L1	3.10		3.50	0.122		0.138
L2	1.70		1.90	0.066		0.075
N1	33°		43°	33°		43°
N2	28°		38°	28°		38°

1. Inches given for reference only

### 3 Ordering information

Figure 9. Ordering information scheme

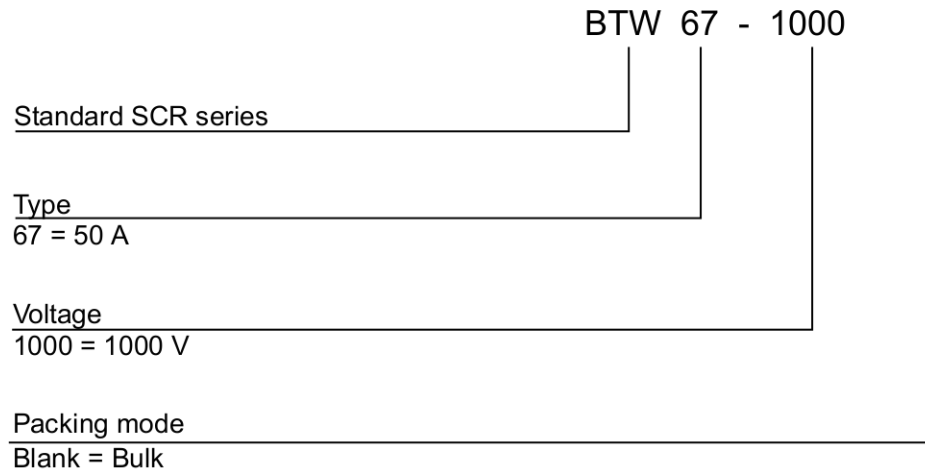

Table 5. Ordering information

Order code	Marking	Package	Weight	Base qty.	Delivery mode
BTW67-1000	BTW671000	RD91	20 g	25	Bulk

## Revision history

**Table 6. Document revision history**

Date	Revision	Changes
Apr-2001	4A	Last update.
13-Feb-2006	5	TOP3 Insulated delivery mode changed from bulk to tube. ECOPACK statement added.
26-Jun-2019	6	Removed TOP3 Ins. package information. Minor text changed.
27-Feb-2023	7	Updated package pinout.



**IMPORTANT NOTICE – READ CAREFULLY**

STMicroelectronics NV and its subsidiaries (“ST”) reserve the right to make changes, corrections, enhancements, modifications, and improvements to ST products and/or to this document at any time without notice. Purchasers should obtain the latest relevant information on ST products before placing orders. ST products are sold pursuant to ST’s terms and conditions of sale in place at the time of order acknowledgment.

Purchasers are solely responsible for the choice, selection, and use of ST products and ST assumes no liability for application assistance or the design of purchasers’ products.

No license, express or implied, to any intellectual property right is granted by ST herein.

Resale of ST products with provisions different from the information set forth herein shall void any warranty granted by ST for such product.

ST and the ST logo are trademarks of ST. For additional information about ST trademarks, refer to [www.st.com/trademarks](http://www.st.com/trademarks). All other product or service names are the property of their respective owners.

Information in this document supersedes and replaces information previously supplied in any prior versions of this document.

© 2023 STMicroelectronics – All rights reserved