

Features

- Peak pulse power:
 - 600 W (10/1000 μ s)
 - 4 kW (8/20 μ s)
- Stand off voltage range: from 5 V to 188 V
- Unidirectional and bidirectional types
- Low leakage current:
 - 0.2 μ A at 25 °C
 - 1 μ A at 85 °C
- Operating $T_{j\max}$: 150 °C
- High power capability at $T_{j\max}$:
 - 515 W (10/1000 μ s)
- JEDEC registered package outline

Complies with the following standards

- IEC 61000-4-2 level 4:
 - 15 kV (air discharge)
 - 8 kV (contact discharge)
- IEC 61000-4-5
- MIL STD 883G, method 3015-7 Class 3B:
 - 25 kV HBM (human body model)
- Resin meets UL 94, V0
- MIL-STD-750, method 2026 solderability
- EIA STD RS-481 and IEC 60286-3 packing
- IPC 7531 footprint

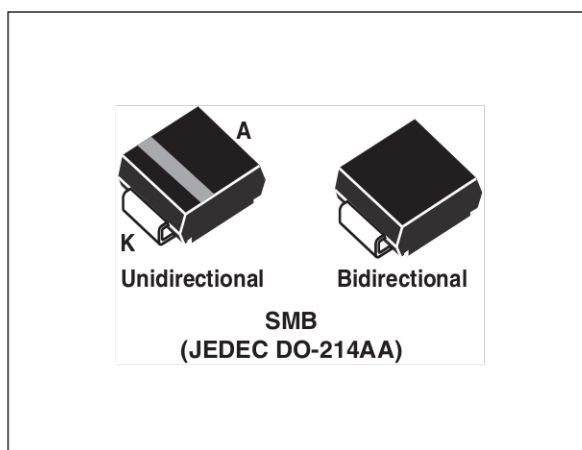

Description

The SMBJ Transil series has been designed to protect sensitive equipment against electrostatic discharges according to IEC 61000-4-2, and MIL STD 883, method 3015, and electrical over stress according to IEC 61000-4-4 and 5. These devices are more generally used against surges below 600 W (10/1000 μ s).

Planar technology makes these devices suitable for high-end equipment and SMPS where low leakage current and high junction temperature are required to provide reliability and stability over time.

SMBJ are packaged in SMB (SMB footprint in accordance with IPC 7531 standard).

TM: Transil is a trademark of STMicroelectronics

1 Characteristics

Table 1. Absolute maximum ratings ($T_{amb} = 25\text{ }^{\circ}\text{C}$)

Symbol	Parameter	Value	Unit
P_{PP}	Peak pulse power dissipation ⁽¹⁾	T_j initial = T_{amb} 600	W
T_{stg}	Storage temperature range	-65 to +150	$^{\circ}\text{C}$
T_j	Operating junction temperature range	-55 to +150	$^{\circ}\text{C}$
T_L	Maximum lead temperature for soldering during 10 s.	260	$^{\circ}\text{C}$

1. For a surge greater than the maximum values, the diode will fail in short-circuit.

Table 2. Thermal resistances

Symbol	Parameter	Value	Unit
$R_{th(j-l)}$	Junction to leads	20	$^{\circ}\text{C}/\text{W}$
$R_{th(j-a)}$	Junction to ambient on recommended pad layout	100	$^{\circ}\text{C}/\text{W}$

Figure 1. Electrical characteristics - definitions

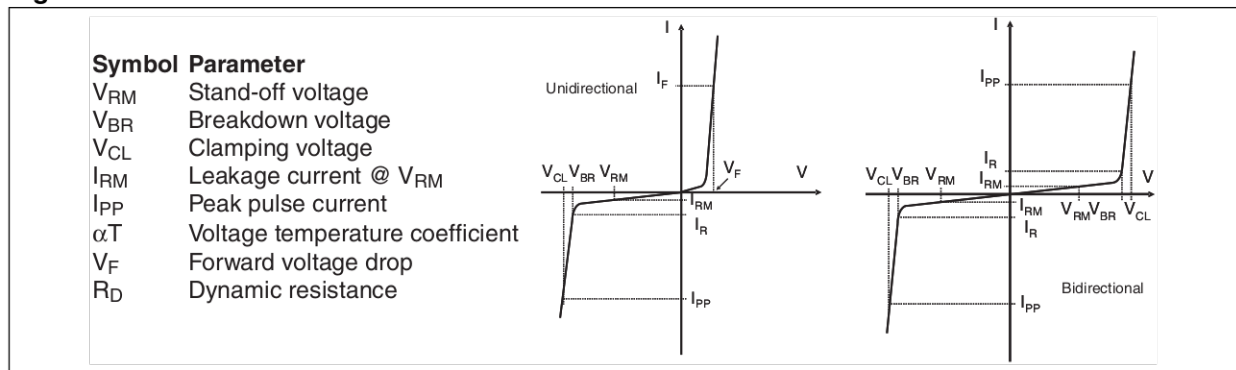

Figure 2. Pulse definition for electrical characteristics

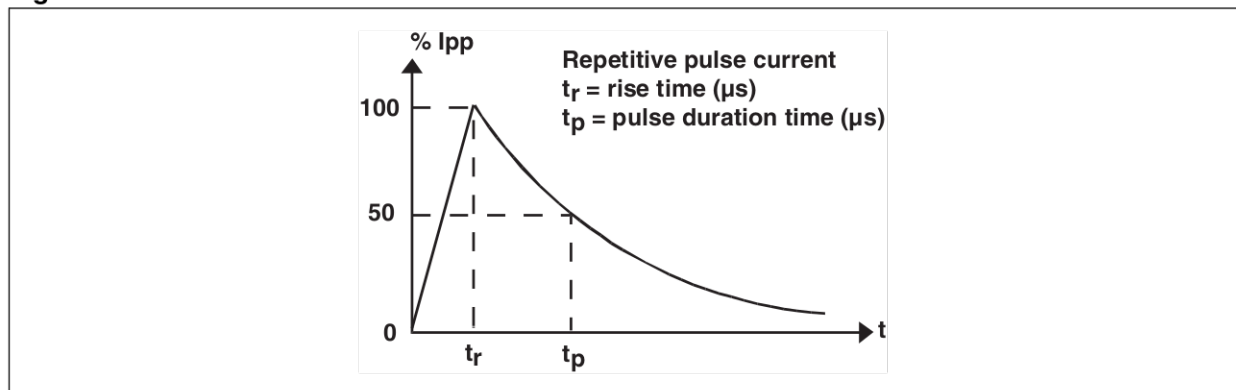

Table 3. Electrical characteristics - parameter values ($T_{amb} = 25\text{ °C}$)

Order code	$I_{RM} \text{ max}@V_{RM}$			$V_{BR} @I_R^{(1)}$			$V_{CL} @I_{PP}$ 10/1000 μs		$R_D^{(2)}$ 10/1000 μs		$V_{CL} @I_{PP}$ 8/20 μs		$R_D^{(2)}$ 8/20 μs		$\alpha T^{(3)}$
	25 °C	85 °C		min	typ		max			max			max		
	μA		V	V		mA	V	A ⁽⁴⁾	Ω	V	A ⁽⁴⁾	Ω	10-4/ °C		
SMBJ5.0A/CA	20	50	5.0	6.4	6.74	10	9.2	68	0.031	13.4	298	0.021	5.7		
SMBJ6.0A/CA	20	50	6.0	6.7	7.05	10	10.3	61	0.048	13.7	290	0.022	5.9		
SMBJ6.5A/CA	20	50	6.5	7.2	7.58	10	11.2	56	0.058	14.5	276	0.024	6.1		
SMBJ8.5A/CA	20	50	8.5	9.4	9.9	1	14.4	41.7	0.096	19.5	205	0.044	7.3		
SMBJ10A/CA	0.2	1	10	11.1	11.7	1	17	37	0.127	21.7	184	0.051	7.8		
SMBJ12A/CA	0.2	1	12	13.3	14	1	19.9	31	0.168	25.3	157	0.068	8.3		
SMBJ13A/CA	0.2	1	13	14.4	15.2	1	21.5	29	0.191	27.2	147	0.076	8.4		
SMBJ15A/CA	0.2	1	15	16.7	17.6	1	24.4	25.1	0.236	32.5	123	0.114	8.8		
SMBJ16A/CA	0.2	1	16	17.8	18.7	1	26	23.1	0.276	34.4	116	0.127	8.8		
SMBJ18A/CA	0.2	1	18	20.0	21.1	1	29.2	21.5	0.328	39.3	102	0.168	9.2		
SMBJ20A/CA	0.2	1	20	22.2	23.4	1	32.4	19.4	0.404	42.8	93	0.196	9.4		
SMBJ22A/CA	0.2	1	22	24.4	25.7	1	35.5	17.7	0.481	48.3	83	0.257	9.6		
SMBJ24A/CA	0.2	1	24	26.7	28.1	1	38.9	16	0.587	50	80	0.256	9.6		
SMBJ26A/CA	0.2	1	26	28.9	30.4	1	42.1	14.9	0.683	53.5	75	0.288	9.7		
SMBJ28A/CA	0.2	1	28	31.1	32.7	1	45.4	13.8	0.802	59	68	0.363	9.8		
SMBJ30A/CA	0.2	1	30	33.3	35.1	1	48.4	13	0.888	64.3	62	0.443	9.9		
SMBJ33A/CA	0.2	1	33	36.7	38.6	1	53.3	11.8	1.08	69.7	57	0.512	10.0		
SMBJ36A/CA	0.2	1	36	40.0	42.1	1	58.1	10.3	1.35	76	52	0.611	10.0		
SMBJ40A/CA	0.2	1	40	44.4	46.7	1	64.5	9.7	1.59	84	48	0.728	10.1		
SMBJ48A/CA	0.2	1	48	53.3	56.1	1	77.4	8.1	2.28	100	40	1.03	10.3		
SMBJ58A/CA	0.2	1	58	64.4	67.8	1	93.6	6.7	3.34	121	33	1.51	10.4		
SMBJ70A/CA	0.2	1	70	77.8	81.9	1	113	5.5	4.91	146	27	2.22	10.5		
SMBJ85A/CA	0.2	1	85	94	99	1	137	4.6	7.18	178	22.5	3.29	10.6		
SMBJ100A/CA	0.2	1	100	111	117	1	162	3.8	10.3	212	19	4.69	10.7		
SMBJ130A/CA	0.2	1	130	144	152	1	209	3	16.5	265	15	7.03	10.8		
SMBJ154A/CA	0.2	1	154	171	180	1	246	2.4	23.8	317	12.6	10.2	10.8		
SMBJ170A/CA	0.2	1	170	189	199	1	275	2.2	30.0	353	11.3	12.7	10.8		
SMBJ188A/CA	0.2	1	188	209	220	1	328	2	48.5	388	10.3	15.2	10.8		

1. Pulse test : $t_p < 50\text{ ms}$

2. To calculate maximum clamping voltage at other surge level, use the following formula: $V_{CLmax} = V_{CL} - R_D \times (I_{PP} - I_{PPappli})$
where $I_{PPappli}$ is the surge current in the application

3. To calculate V_{BR} or V_{CL} versus junction temperature, use the following formulas:
 $V_{BR} @ T_J = V_{BR} @ 25\text{ °C} \times (1 + \alpha T \times (T_J - 25))$
 $V_{CL} @ T_J = V_{CL} @ 25\text{ °C} \times (1 + \alpha T \times (T_J - 25))$

4. Surge capability given for both directions for unidirectional and bidirectional types.

Figure 3. Peak pulse power dissipation versus initial junction temperature

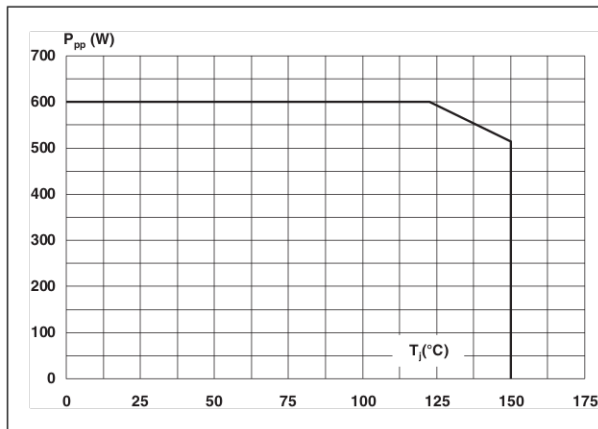

Figure 4. Peak pulse power versus exponential pulse duration (T_j initial = 25 °C)

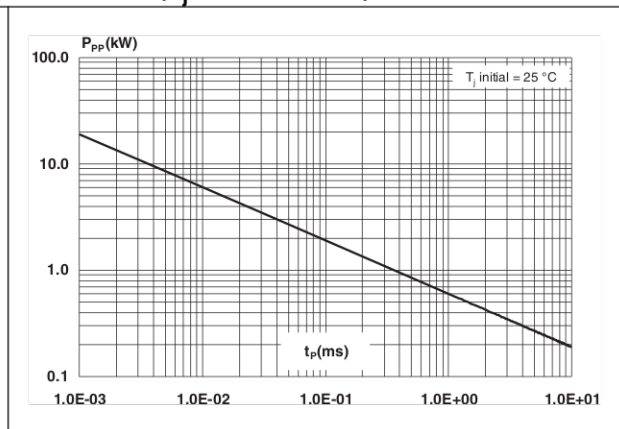

Figure 5. Clamping voltage versus peak pulse current (exponential waveform, maximum values)

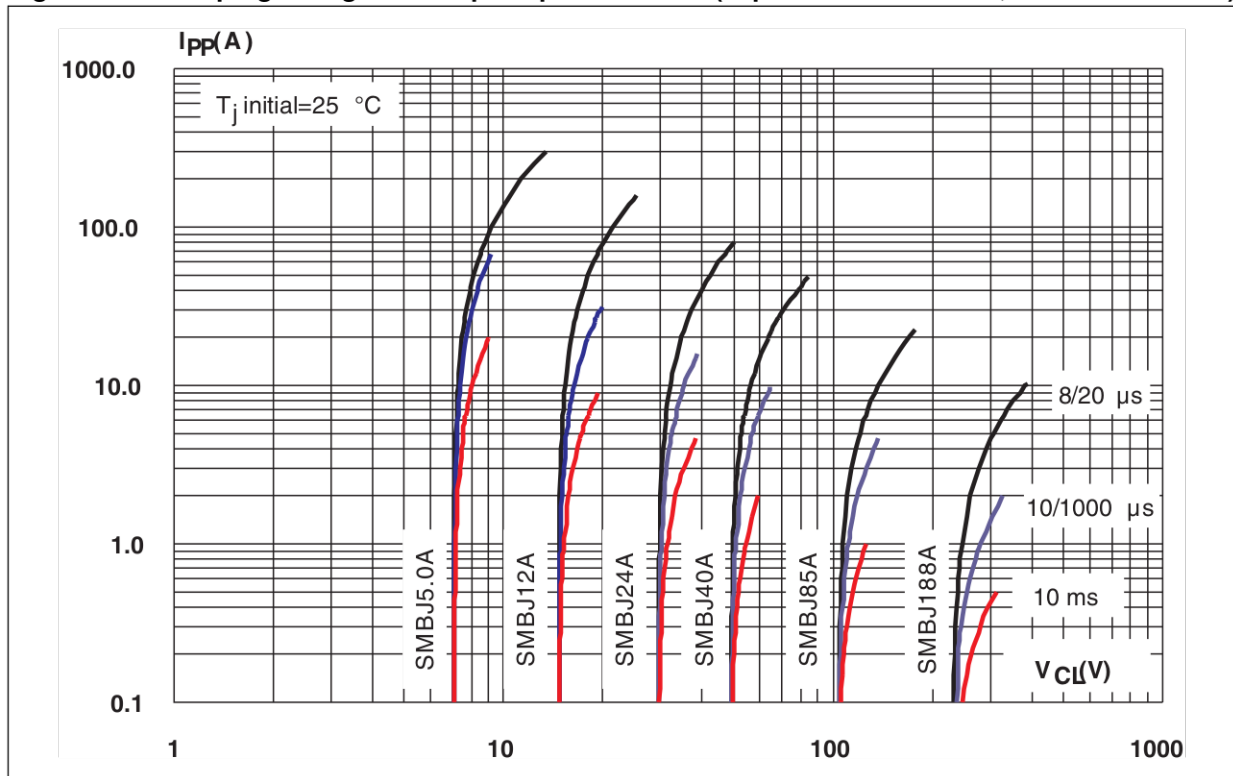

Figure 6. Junction capacitance versus reverse applied voltage for unidirectional types (typical values)

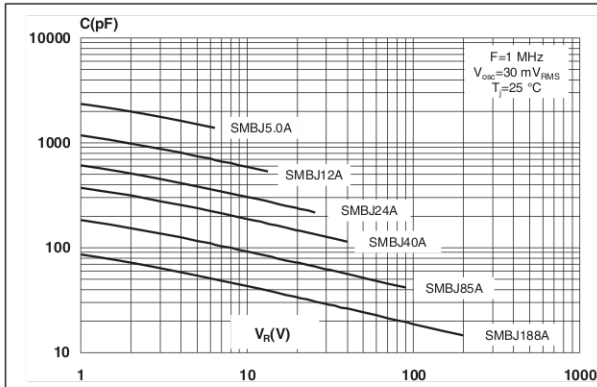

Figure 7. Junction capacitance versus reverse applied voltage for bidirectional types (typical values)

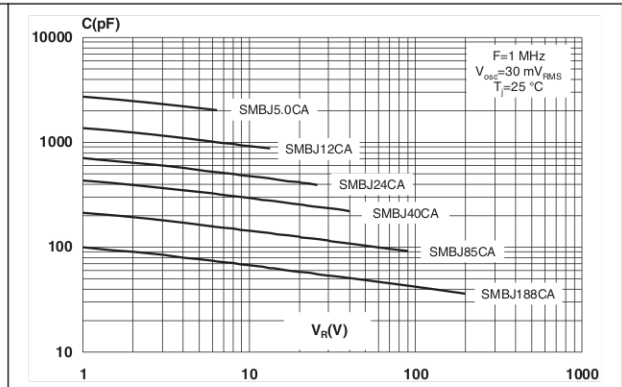

Figure 8. Peak forward voltage drop versus peak forward current (typical values)

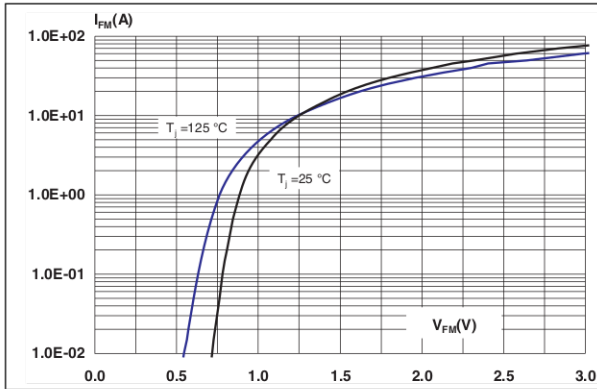

Figure 9. Relative variation of thermal impedance, junction to ambient, versus pulse duration

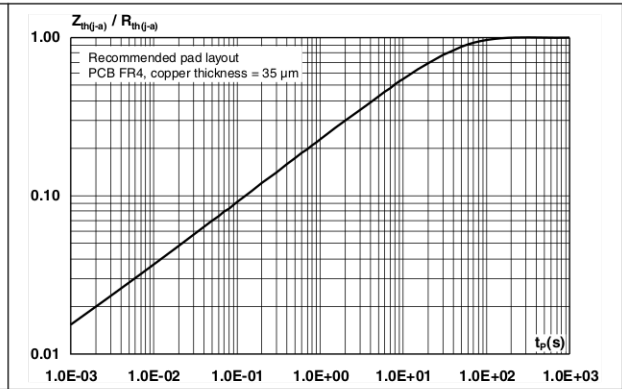

Figure 10. Thermal resistance, junction to ambient, versus copper surface under each lead

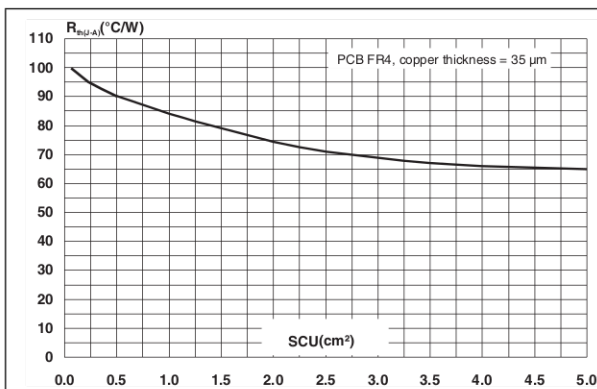
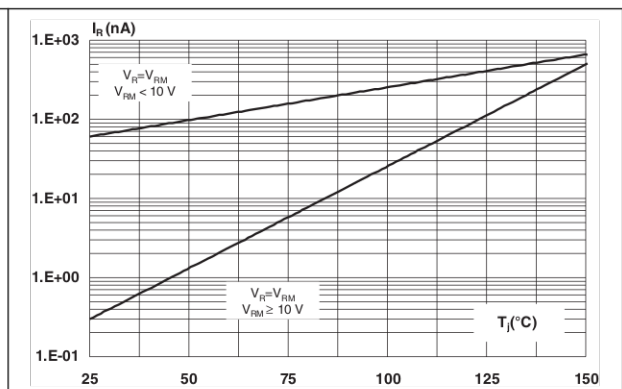
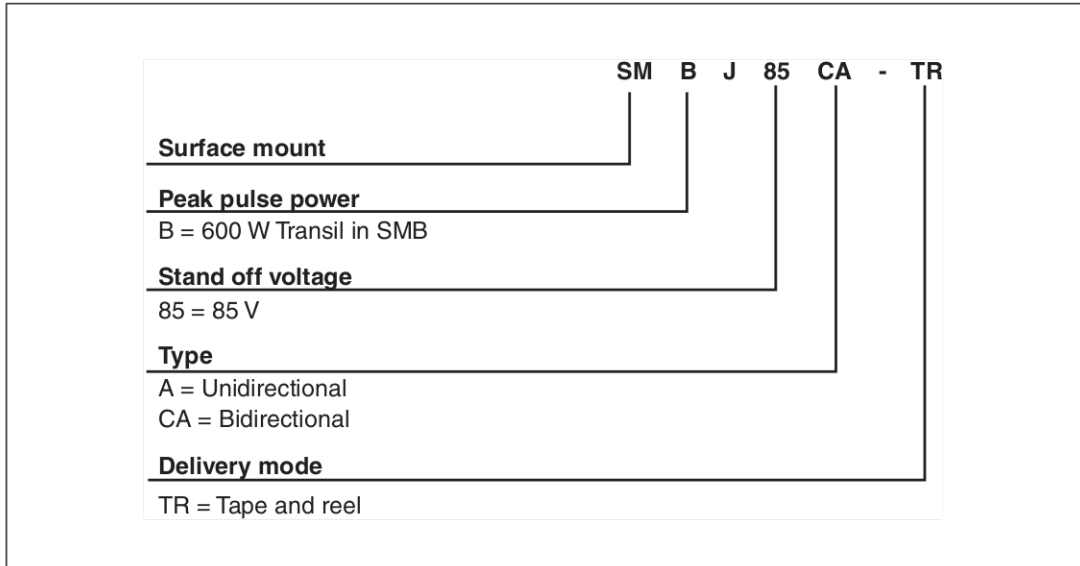

Figure 11. Leakage current versus junction temperature (typical values)



2 Ordering information scheme

Figure 12. Ordering information scheme



3 Package information

- Case: JEDEC DO-214AA molded plastic over planar junction
- Terminals: solder plated - solderable per MIL-STD-750, Method 2026
- Polarity: for unidirectional types the band indicates cathode
- Flammability: epoxy is rated UL94V-0
- RoHS package

In order to meet environmental requirements, ST offers these devices in different grades of ECOPACK® packages, depending on their level of environmental compliance. ECOPACK® specifications, grade definitions and product status are available at: www.st.com. ECOPACK® is an ST trademark.

Table 4. SMB dimensions

Ref.	Dimensions			
	Millimeters		Inches	
	Min.	Max.	Min.	Max.
A1	1.90	2.45	0.075	0.096
A2	0.05	0.20	0.002	0.008
b	1.95	2.20	0.077	0.087
c	0.15	0.40	0.006	0.016
D	3.30	3.95	0.130	0.156
E	5.10	5.60	0.201	0.220
E1	4.05	4.60	0.159	0.181
L	0.75	1.50	0.030	0.059

Figure 13. Footprint dimensions in mm (inches)

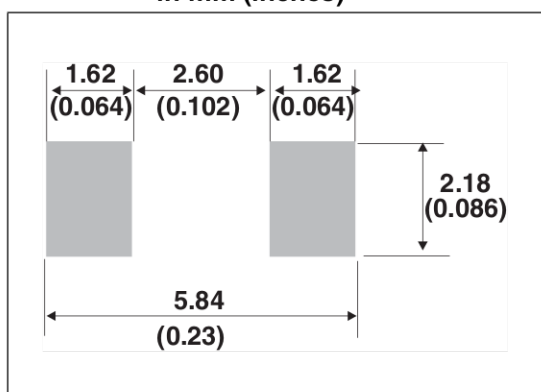
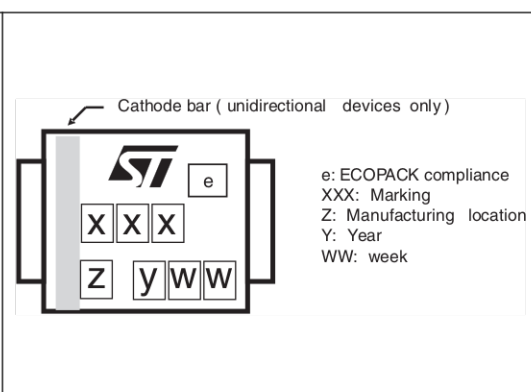

Figure 14. Marking layout⁽¹⁾



1. Marking layout can vary according to assembly location.

Table 5. Marking

Order code	Marking	Order code	Marking
SMBJ5.0A-TR	BUZ	SMBJ5.0CA-TR	BBZ
SMBJ6.0A-TR	BUA	SMBJ6.0CA-TR	BBA
SMBJ6.5A-TR	BUB	SMBJ6.5CA-TR	BBB
SMBJ8.5A-TR	BUC	SMBJ8.5CA-TR	BBC
SMBJ10A-TR	BUD	SMBJ10CA-TR	BBD
SMBJ12A-TR	BUE	SMBJ12CA-TR	BBE
SMBJ13A-TR	BUF	SMBJ13CA-TR	BBF
SMBJ15A-TR	BUG	SMBJ15CA-TR	BBG
SMBJ16A-TR	CUG	SMBJ16CA-TR	CBG
SMBJ18A-TR	BUH	SMBJ18CA-TR	BBH
SMBJ20A-TR	BUI	SMBJ20CA-TR	BBI
SMBJ22A-TR	BVA	SMBJ22CA-TR	CBH
SMBJ24A-TR	BUJ	SMBJ24CA-TR	BBJ
SMBJ26A-TR	BUK	SMBJ26CA-TR	BBK
SMBJ28A-TR	BUL	SMBJ28CA-TR	BBL
SMBJ30A-TR	BUM	SMBJ30CA-TR	BBM
SMBJ33A-TR	BUN	SMBJ33CA-TR	BBN
SMBJ36A-TR	CUN	SMBJ36CA-TR	CBN
SMBJ40A-TR	CUJ	SMBJ40CA-TR	CBJ
SMBJ43A-TR	CUW	SMBJ43CA-TR	CBW
SMBJ48A-TR	BUW	SMBJ48CA-TR	BBW
SMBJ58A-TR	BUO	SMBJ58CA-TR	BBO
SMBJ70A-TR	CUM	SMBJ70CA-TR	CBM
SMBJ85A-TR	BUQ	SMBJ85CA-TR	BBQ
SMBJ100A-TR	CUQ	SMBJ100CA-TR	CBQ
SMBJ130A-TR	BUS	SMBJ130CA-TR	BBS
SMBJ154A-TR	BUT	SMBJ154CA-TR	BBT
SMBJ170A-TR	BUU	SMBJ170CA-TR	BBU
SMBJ188A-TR	BUV	SMBJ188CA-TR	BBV

4 Ordering information

Table 6. Order codes

Order code	Marking	Package	Weight	Base qty	Delivery mode
SMBJxxxA/CA-TR ⁽¹⁾	See Table 5 on page 8	SMB	0.11 g	2500	Tape and reel

1. Where xxx is nominal value of V_{BR} and A or CA indicates unidirectional or bidirectional version. See [Table 3](#) for list of available devices and their order codes

5 Revision history

Table 7. Document revision history

Date	Revision	Changes
Oct-2001	4	Previous issue
10-Feb-2005	5	Reformatted to current template. Added directional (uni and bi) indications to graphics. Added ECOPACK statement.
16-Nov-2006	6	Add part numbers SMBJ36A-TR and SMBJ36CA-TR in Table 3 .
14-May-2009	7	Reformatted to current standards. Updated ECOPACK statement. Added part number SMBJ43CA/A
17-Sep-2009	8	Document updated for low leakage current.
09-Jul-2010	9	Changed timescale in Figure 9 .
20-Oct-2010	10	Updated Figure 13 .

Please Read Carefully:

Information in this document is provided solely in connection with ST products. STMicroelectronics NV and its subsidiaries ("ST") reserve the right to make changes, corrections, modifications or improvements, to this document, and the products and services described herein at any time, without notice.

All ST products are sold pursuant to ST's terms and conditions of sale.

Purchasers are solely responsible for the choice, selection and use of the ST products and services described herein, and ST assumes no liability whatsoever relating to the choice, selection or use of the ST products and services described herein.

No license, express or implied, by estoppel or otherwise, to any intellectual property rights is granted under this document. If any part of this document refers to any third party products or services it shall not be deemed a license grant by ST for the use of such third party products or services, or any intellectual property contained therein or considered as a warranty covering the use in any manner whatsoever of such third party products or services or any intellectual property contained therein.

UNLESS OTHERWISE SET FORTH IN ST'S TERMS AND CONDITIONS OF SALE ST DISCLAIMS ANY EXPRESS OR IMPLIED WARRANTY WITH RESPECT TO THE USE AND/OR SALE OF ST PRODUCTS INCLUDING WITHOUT LIMITATION IMPLIED WARRANTIES OF MERCHANTABILITY, FITNESS FOR A PARTICULAR PURPOSE (AND THEIR EQUIVALENTS UNDER THE LAWS OF ANY JURISDICTION), OR INFRINGEMENT OF ANY PATENT, COPYRIGHT OR OTHER INTELLECTUAL PROPERTY RIGHT.

UNLESS EXPRESSLY APPROVED IN WRITING BY AN AUTHORIZED ST REPRESENTATIVE, ST PRODUCTS ARE NOT RECOMMENDED, AUTHORIZED OR WARRANTED FOR USE IN MILITARY, AIR CRAFT, SPACE, LIFE SAVING, OR LIFE SUSTAINING APPLICATIONS, NOR IN PRODUCTS OR SYSTEMS WHERE FAILURE OR MALFUNCTION MAY RESULT IN PERSONAL INJURY, DEATH, OR SEVERE PROPERTY OR ENVIRONMENTAL DAMAGE. ST PRODUCTS WHICH ARE NOT SPECIFIED AS "AUTOMOTIVE GRADE" MAY ONLY BE USED IN AUTOMOTIVE APPLICATIONS AT USER'S OWN RISK.

Resale of ST products with provisions different from the statements and/or technical features set forth in this document shall immediately void any warranty granted by ST for the ST product or service described herein and shall not create or extend in any manner whatsoever, any liability of ST.

ST and the ST logo are trademarks or registered trademarks of ST in various countries.

Information in this document supersedes and replaces all information previously supplied.

The ST logo is a registered trademark of STMicroelectronics. All other names are the property of their respective owners.

© 2010 STMicroelectronics - All rights reserved

STMicroelectronics group of companies

Australia - Belgium - Brazil - Canada - China - Czech Republic - Finland - France - Germany - Hong Kong - India - Israel - Italy - Japan - Malaysia - Malta - Morocco - Philippines - Singapore - Spain - Sweden - Switzerland - United Kingdom - United States of America

www.st.com