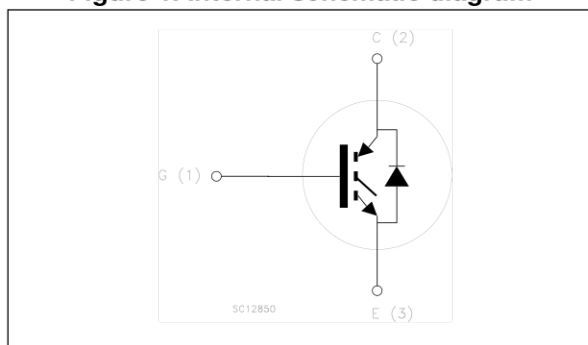

Figure 1. Internal schematic diagram



Features

- Maximum junction temperature: $T_J = 175\text{ °C}$
- Very high speed switching series
- Tail-less switching off
- Low saturation voltage: $V_{CE(sat)} = 1.8\text{ V (typ.)}$ @ $I_C = 20\text{ A}$
- Tight parameters distribution
- Safe paralleling
- Low thermal resistance
- Very fast soft recovery antiparallel diode
- Lead free package

Applications

- Photovoltaic inverters
- Uninterruptible power supply
- Welding
- Power factor correction
- Very high frequency converters

Description

This device is an IGBT developed using an advanced proprietary trench gate and field stop structure. The device is part of the "V" series of IGBTs, which represent an optimum compromise between conduction and switching losses to maximize the efficiency of very high frequency converters. Furthermore, a positive $V_{CE(sat)}$ temperature coefficient and very tight parameter distribution result in safer paralleling operation.

Table 1. Device summary

| Order code | Marking | Package | Packaging |
|--------------|------------|--------------------|---------------|
| STGB20V60DF | GB20V60DF | D ² PAK | Tape and reel |
| STGP20V60DF | GP20V60DF | TO-220 | Tube |
| STGW20V60DF | GW20V60DF | TO-247 | Tube |
| STGWT20V60DF | GWT20V60DF | TO-3P | Tube |

Contents

| | | |
|----------|---|-----------|
| 1 | Electrical ratings | 3 |
| 2 | Electrical characteristics | 4 |
| 2.1 | Electrical characteristics (curves) | 6 |
| 3 | Test circuits | 11 |
| 4 | Package mechanical data | 12 |
| 5 | Packing mechanical data | 20 |
| 6 | Revision history | 22 |

1 Electrical ratings

Table 2. Absolute maximum ratings

| Symbol | Parameter | Value | Unit |
|----------------|---|-------------|------|
| V_{CES} | Collector-emitter voltage ($V_{GE} = 0$) | 600 | V |
| I_C | Continuous collector current at $T_C = 25\text{ °C}$ | 40 | A |
| I_C | Continuous collector current at $T_C = 100\text{ °C}$ | 20 | A |
| $I_{CP}^{(1)}$ | Pulsed collector current | 80 | A |
| V_{GE} | Gate-emitter voltage | ± 20 | V |
| I_F | Continuous forward current at $T_C = 25\text{ °C}$ | 40 | A |
| I_F | Continuous forward current at $T_C = 100\text{ °C}$ | 20 | A |
| $I_{FP(1)}$ | Pulsed forward current | 80 | A |
| P_{TOT} | Total dissipation at $T_C = 25\text{ °C}$ | 167 | W |
| T_{STG} | Storage temperature range | - 55 to 150 | °C |
| T_J | Operating junction temperature | - 55 to 175 | °C |

1. Pulse width limited by maximum junction temperature and turn-off within RBSOA

Table 3. Thermal data

| Symbol | Parameter | Value | Unit |
|------------|--|-------|------|
| R_{thJC} | Thermal resistance junction-case IGBT | 0.9 | °C/W |
| R_{thJC} | Thermal resistance junction-case diode | 2.08 | °C/W |
| R_{thJA} | Thermal resistance junction-ambient | 50 | °C/W |

2 Electrical characteristics

$T_J = 25\text{ °C}$ unless otherwise specified.

Table 4. Static characteristics

| Symbol | Parameter | Test conditions | Min. | Typ. | Max. | Unit |
|---------------|--|--|------|------|------|---------------|
| $V_{(BR)CES}$ | Collector-emitter breakdown voltage ($V_{GE} = 0$) | $I_C = 2\text{ mA}$ | 600 | | | V |
| $V_{CE(sat)}$ | Collector-emitter saturation voltage | $V_{GE} = 15\text{ V}, I_C = 20\text{ A}$ | | 1.8 | 2.2 | V |
| | | $V_{GE} = 15\text{ V}, I_C = 20\text{ A}$ $T_J = 125\text{ °C}$ | | 2.15 | | |
| | | $V_{GE} = 15\text{ V}, I_C = 20\text{ A}$ $T_J = 175\text{ °C}$ | | 2.3 | | |
| V_F | Forward on-voltage | $I_F = 20\text{ A}$ | | 1.7 | 2.2 | V |
| | | $I_F = 20\text{ A}, T_J = 125\text{ °C}$ | | 1.55 | | V |
| | | $I_F = 20\text{ A}, T_J = 175\text{ °C}$ | | 1.3 | | V |
| $V_{GE(th)}$ | Gate threshold voltage | $V_{CE} = V_{GE}, I_C = 1\text{ mA}$ | 5 | 6 | 7 | V |
| I_{CES} | Collector cut-off current ($V_{GE} = 0$) | $V_{CE} = 600\text{ V}$ | | | 25 | μA |
| I_{GES} | Gate-emitter leakage current ($V_{CE} = 0$) | $V_{GE} = \pm 20\text{ V}$ | | | 250 | nA |

Table 5. Dynamic characteristics

| Symbol | Parameter | Test conditions | Min. | Typ. | Max. | Unit |
|-----------|------------------------------|--|------|------|------|------|
| C_{ies} | Input capacitance | $V_{CE} = 25\text{ V}, f = 1\text{ MHz},$ $V_{GE} = 0$ | - | 2800 | - | pF |
| C_{oes} | Output capacitance | | - | 110 | - | pF |
| C_{res} | Reverse transfer capacitance | | - | 64 | - | pF |
| Q_g | Total gate charge | $V_{CC} = 480\text{ V}, I_C = 20\text{ A},$ $V_{GE} = 15\text{ V},$ see Figure 29 | - | 116 | - | nC |
| Q_{ge} | Gate-emitter charge | | - | 24 | - | nC |
| Q_{gc} | Gate-collector charge | | - | 50 | - | nC |

Table 6. IGBT switching characteristics (inductive load)

| Symbol | Parameter | Test conditions | Min. | Typ. | Max. | Unit |
|-----------------|---------------------------|---|------|------|---------|------------|
| $t_{d(on)}$ | Turn-on delay time | $V_{CE} = 400\text{ V}$, $I_C = 20\text{ A}$, $V_{GE} = 15\text{ V}$, see Figure 28 | - | 38 | - | ns |
| t_r | Current rise time | | - | 10 | - | ns |
| $(di/dt)_{on}$ | Turn-on current slope | | - | 1556 | - | A/ μ s |
| $t_{d(off)}$ | Turn-off delay time | | - | 149 | - | ns |
| t_f | Current fall time | | - | 15 | - | ns |
| $E_{on}^{(1)}$ | Turn-on switching losses | | - | 200 | - | μ J |
| $E_{off}^{(2)}$ | Turn-off switching losses | | - | 130 | - | μ J |
| E_{ts} | Total switching losses | - | 330 | - | μ J | |
| $t_{d(on)}$ | Turn-on delay time | $V_{CE} = 400\text{ V}$, $I_C = 20\text{ A}$, $di/dt = 1000\text{ A}/\mu\text{s}$, $V_{GE} = 15\text{ V}$, $T_J = 175\text{ }^\circ\text{C}$, see Figure 28 | - | 37 | - | ns |
| t_r | Current rise time | | - | 12 | - | ns |
| $(di/dt)_{on}$ | Turn-on current slope | | - | 1340 | - | A/ μ s |
| $t_{d(off)}$ | Turn-off delay time | | - | 150 | - | ns |
| t_f | Current fall time | | - | 23 | - | ns |
| $E_{on}^{(1)}$ | Turn-on switching losses | | - | 430 | - | μ J |
| $E_{off}^{(2)}$ | Turn-off switching losses | | - | 210 | - | μ J |
| E_{ts} | Total switching losses | - | 640 | - | μ J | |

1. Energy losses include reverse recovery of the diode.
2. Turn-off losses include also the tail of the collector current.

Table 7. Diode switching characteristics (inductive load)

| Symbol | Parameter | Test conditions | Min. | Typ. | Max. | Unit |
|--------------|--|--|------|------|------|------------|
| t_{rr} | Reverse recovery time | $I_F = 20\text{ A}$, $V_R = 400\text{ V}$, $V_{GE} = 15\text{ V}$, see Figure 28 $di/dt = 1000\text{ A}/\mu\text{s}$ | - | 40 | - | ns |
| Q_{rr} | Reverse recovery charge | | - | 320 | - | nC |
| I_{rrm} | Reverse recovery current | | - | 16 | - | A |
| dl_{rr}/dt | Peak rate of fall of reverse recovery current during t_b | | - | 910 | - | A/ μ s |
| E_{rr} | Reverse recovery energy | | - | 115 | - | μ J |
| t_{rr} | Reverse recovery time | $I_F = 20\text{ A}$, $V_R = 400\text{ V}$, $V_{GE} = 15\text{ V}$, $T_J = 175\text{ }^\circ\text{C}$, see Figure 28 $di/dt = 1000\text{ A}/\mu\text{s}$ | - | 72 | - | ns |
| Q_{rr} | Reverse recovery charge | | - | 930 | - | nC |
| I_{rrm} | Reverse recovery current | | - | 26 | - | A |
| dl_{rr}/dt | Peak rate of fall of reverse recovery current during t_b | | - | 530 | - | A/ μ s |
| E_{rr} | Reverse recovery energy | | - | 307 | - | μ J |

2.1 Electrical characteristics (curves)

Figure 2. Power dissipation vs. case temperature

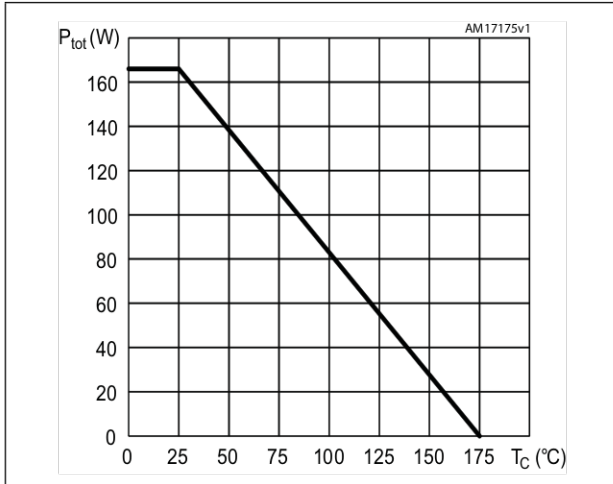

Figure 3. Collector current vs. case temperature

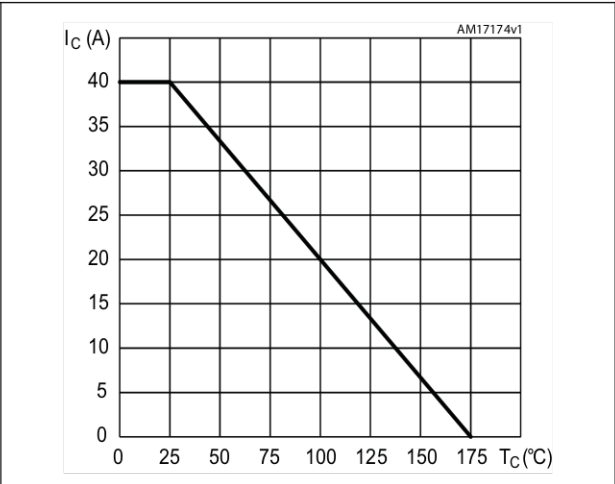

Figure 4. Output characteristics ($T_J = 25^\circ\text{C}$)

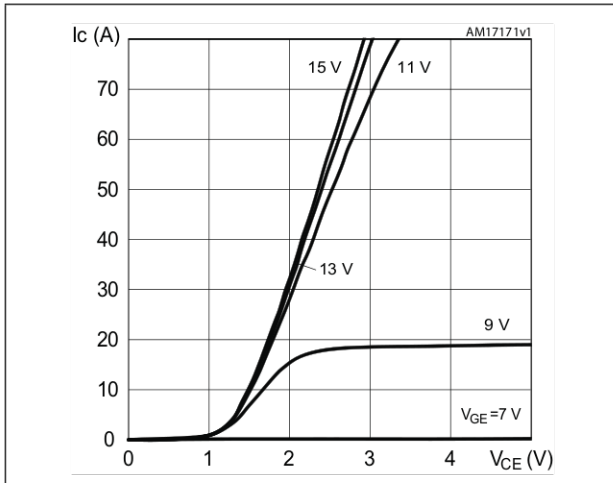

Figure 5. Output characteristics ($T_J = 175^\circ\text{C}$)

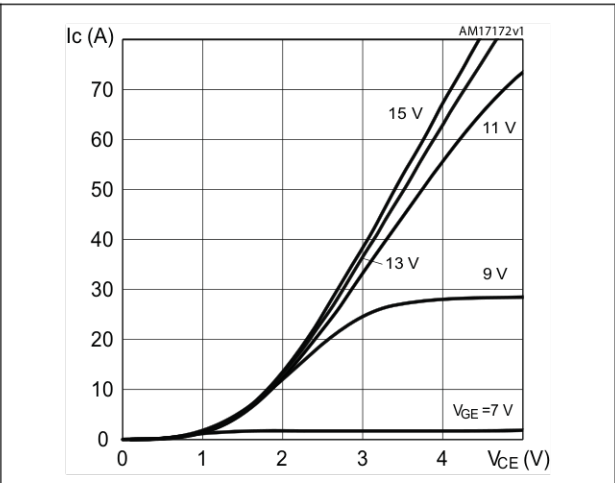

Figure 6. $V_{CE(SAT)}$ vs. junction temperature

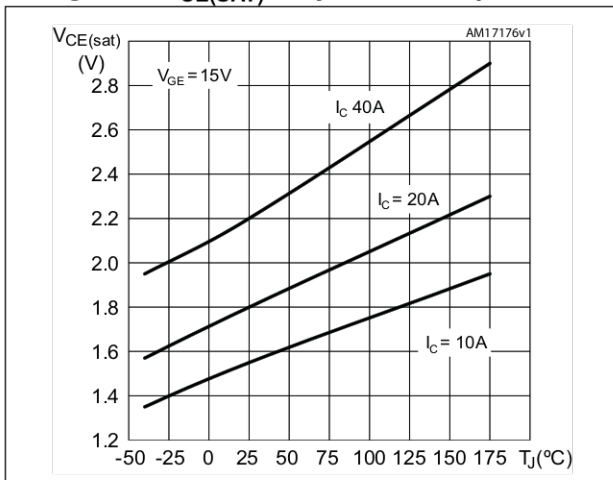

Figure 7. $V_{CE(SAT)}$ vs. collector current

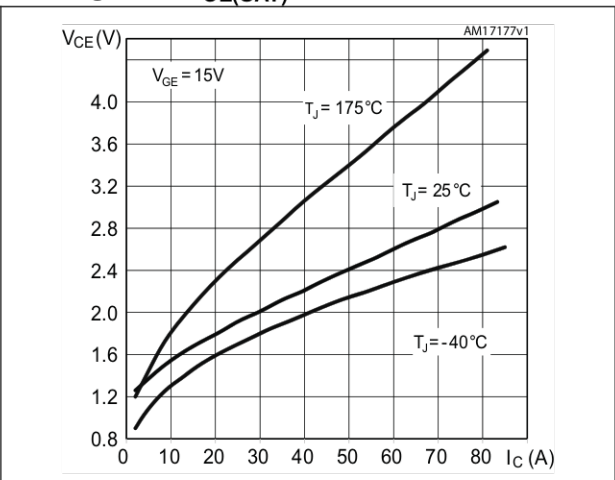

Figure 8. Collector current vs. switching frequency

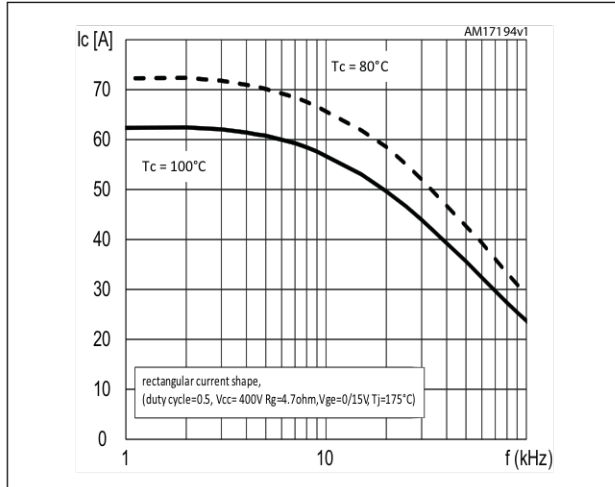

Figure 9. Forward bias safe operating area

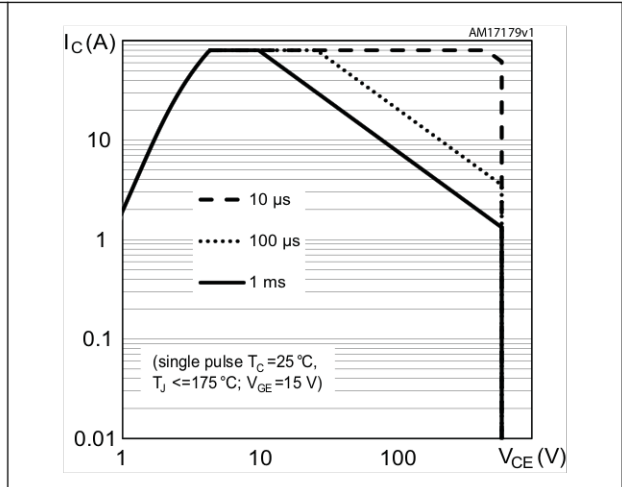

Figure 10. Transfer characteristics

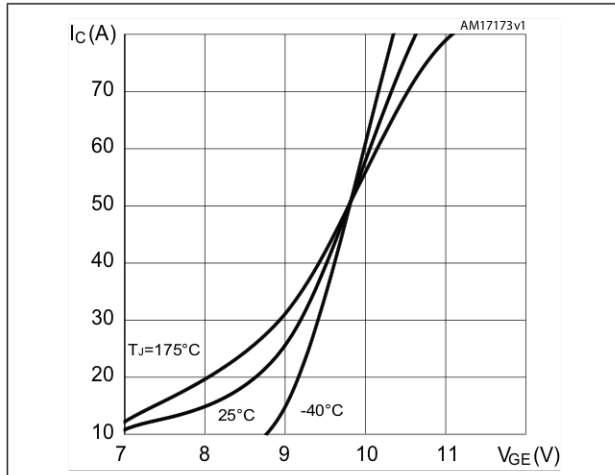

Figure 11. Diode V_F vs. forward current

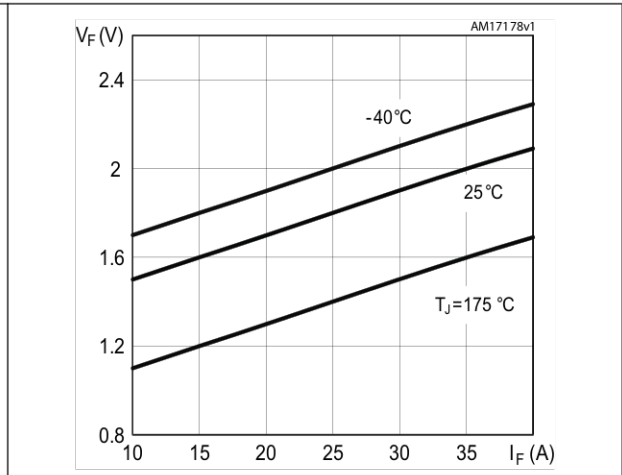

Figure 12. Normalized $V_{GE(th)}$ vs. junction temperature

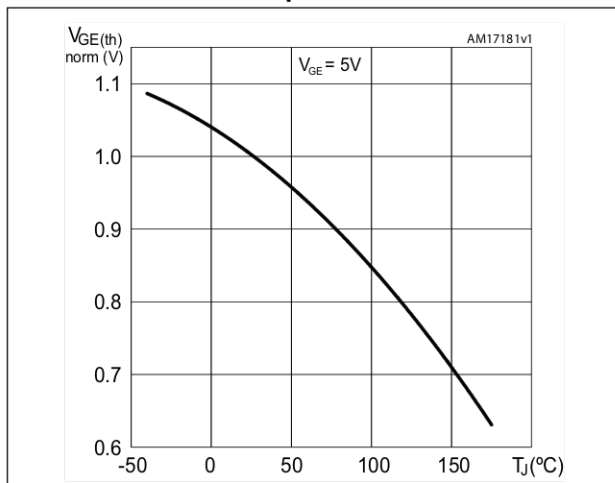

Figure 13. Normalized BV_{CES} vs. junction temperature

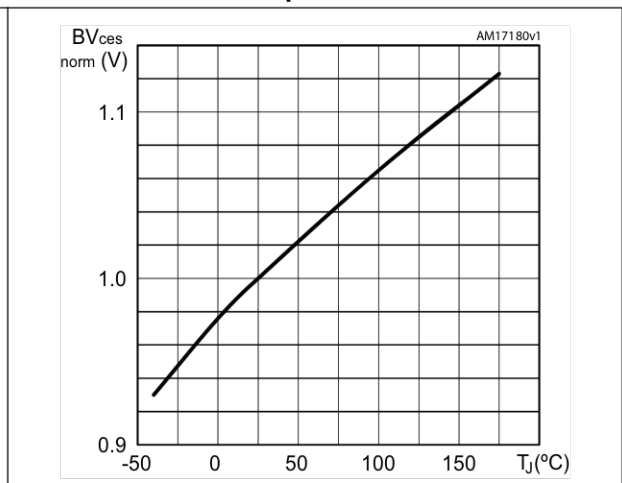

Figure 14. Capacitance variations

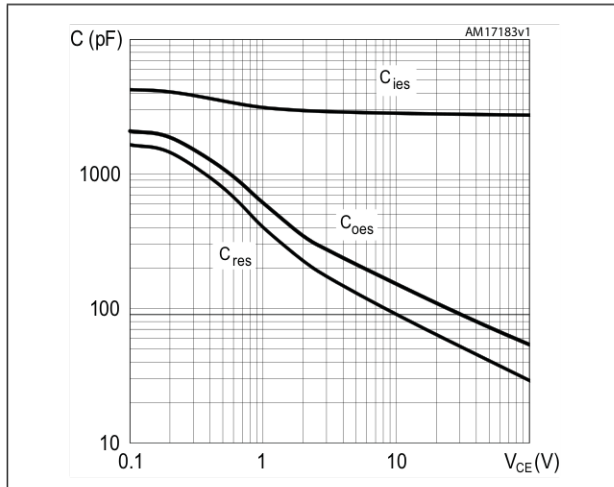

Figure 15. Gate charge vs. gate-emitter voltage

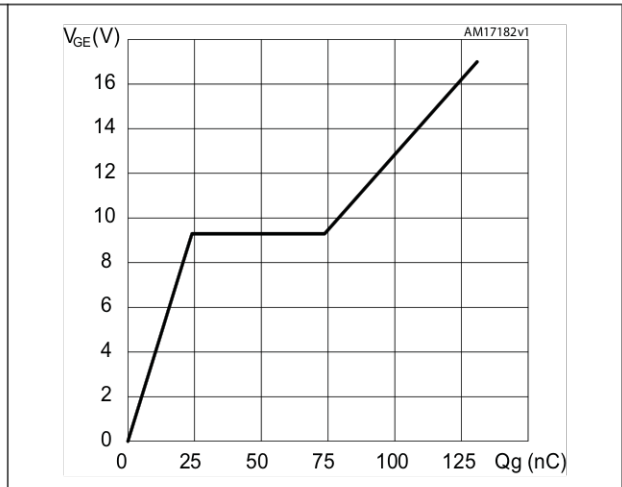

Figure 16. Switching losses vs. collector current

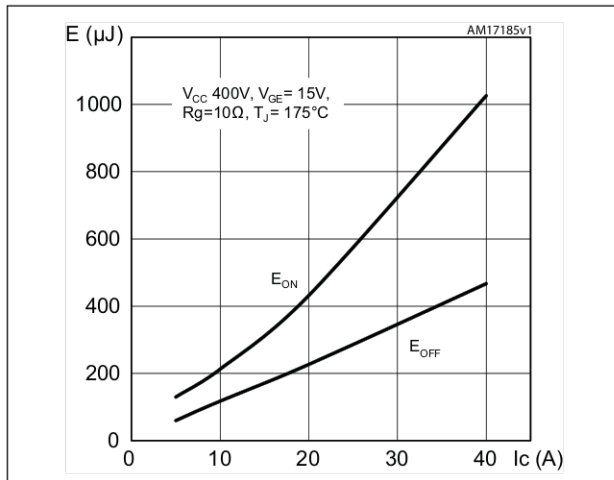

Figure 17. Switching losses vs. gate resistance

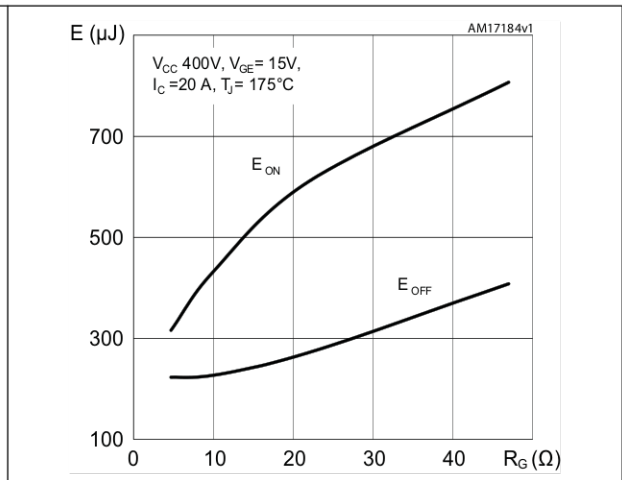

Figure 18. Switching losses vs. junction temperature

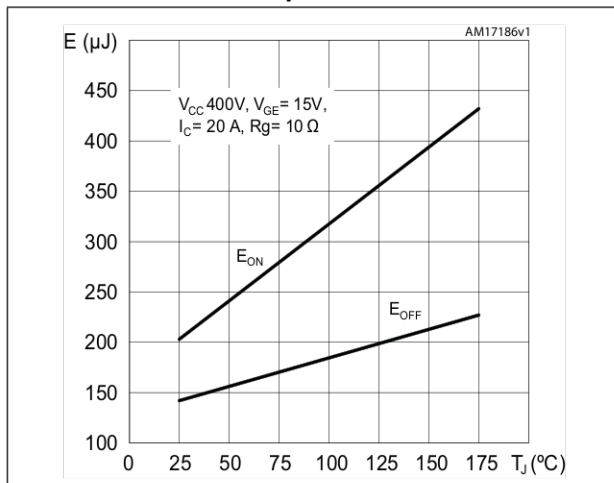

Figure 19. Switching losses vs. collector emitter voltage

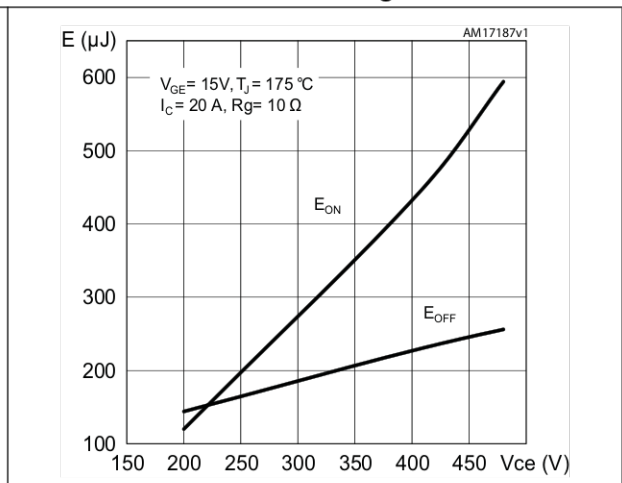

Figure 20. Switching times vs. collector current Figure 21. Switching times vs. gate resistance

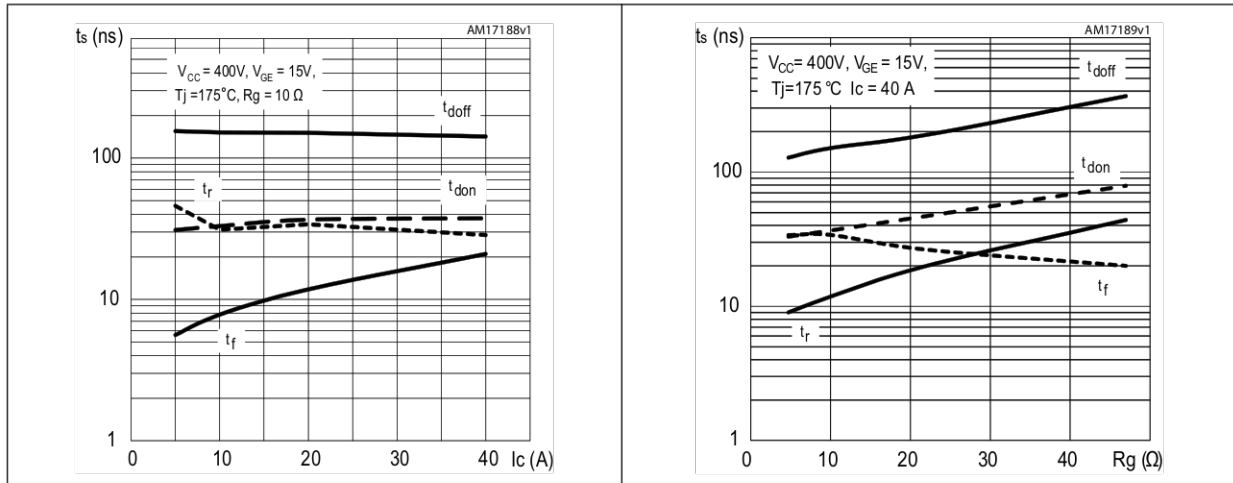

Figure 22. Reverse recovery current vs. diode current slope

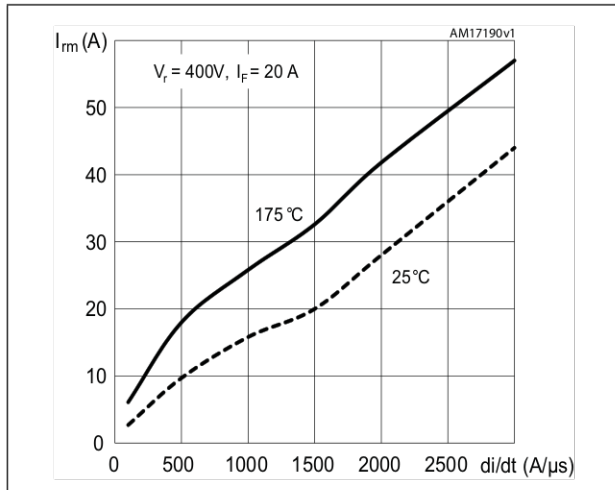

Figure 23. Reverse recovery time vs. diode current slope

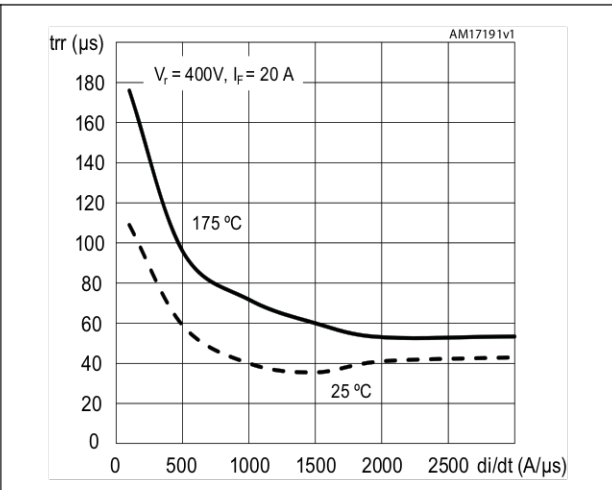

Figure 24. Reverse recovery charge vs. diode current slope

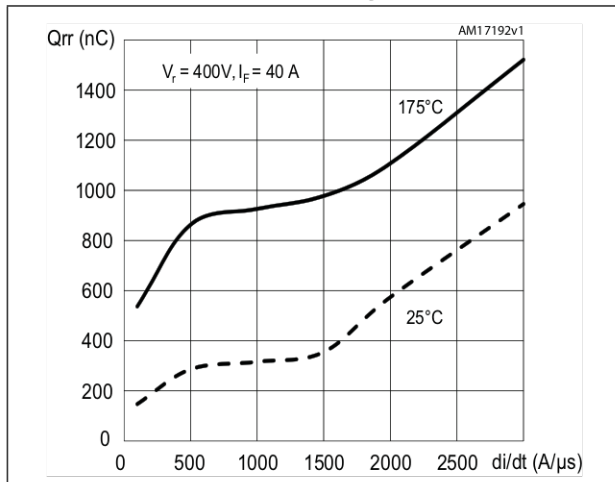

Figure 25. Reverse recovery energy vs. diode current slope

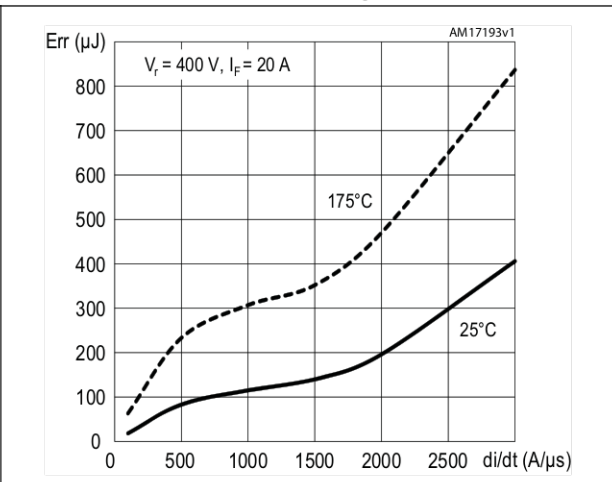

Figure 26. Thermal data for IGBT

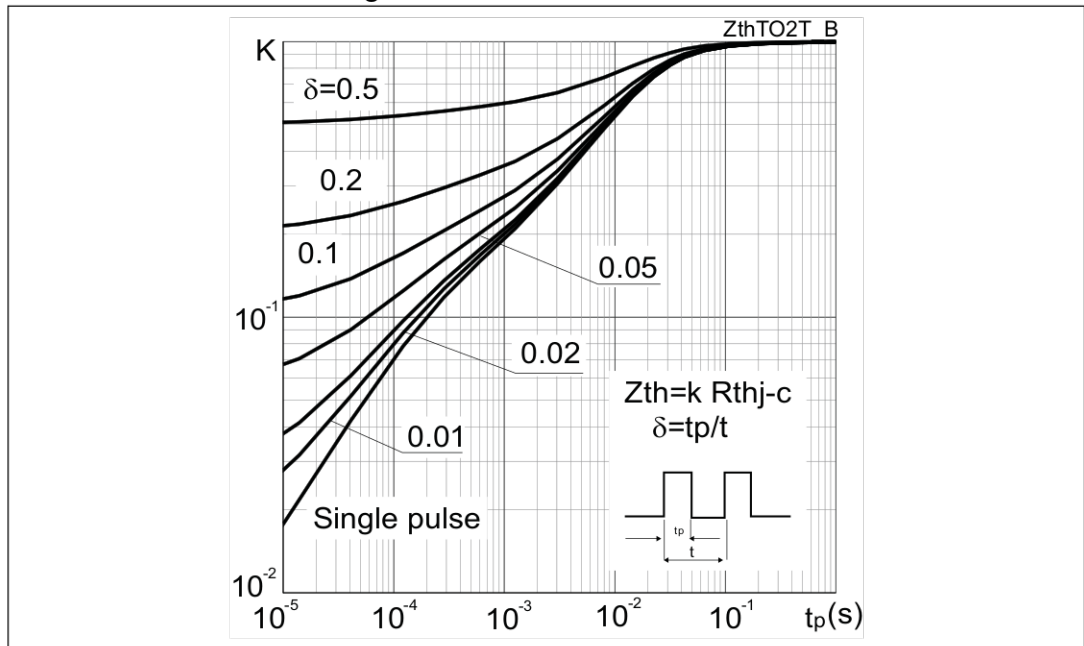
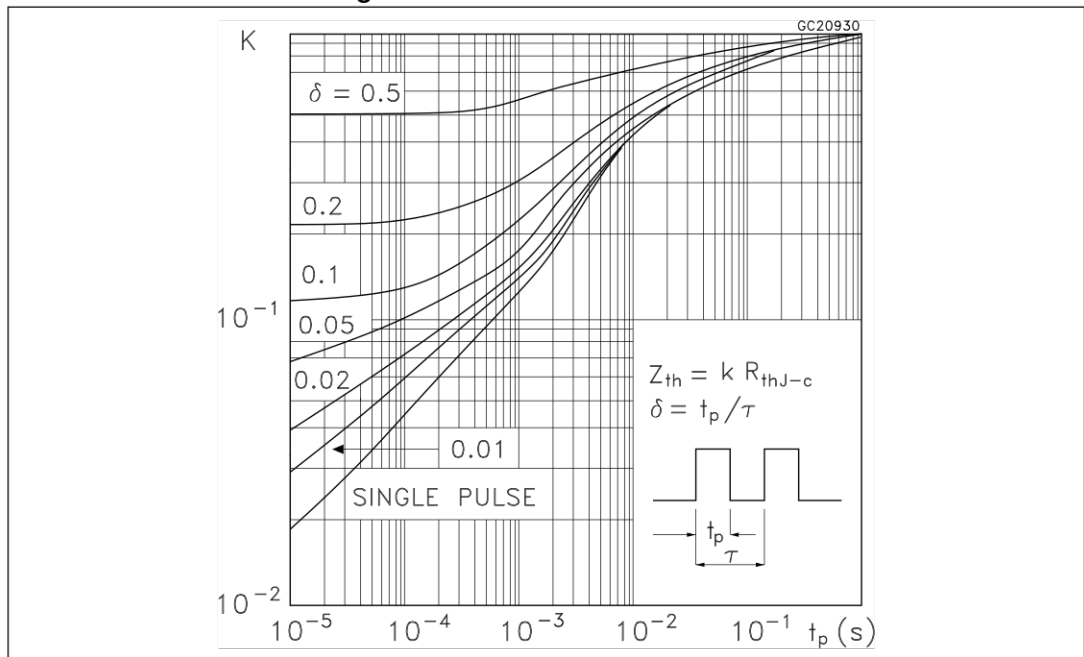

Figure 27. Thermal data for diode



3 Test circuits

Figure 28. Test circuit for inductive load switching

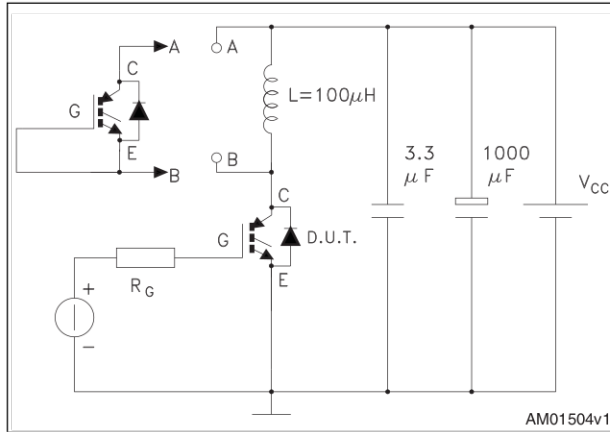

Figure 29. Gate charge test circuit

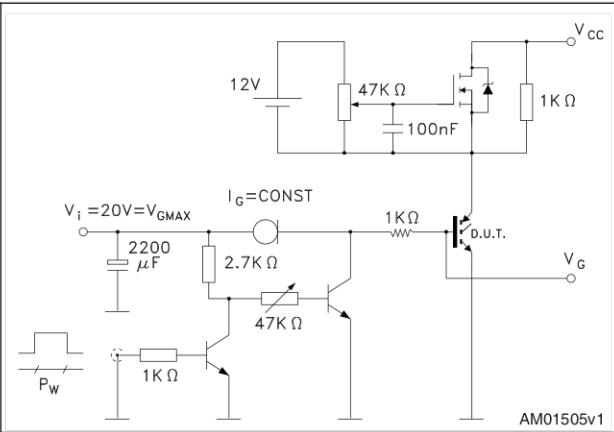

Figure 30. Switching waveform

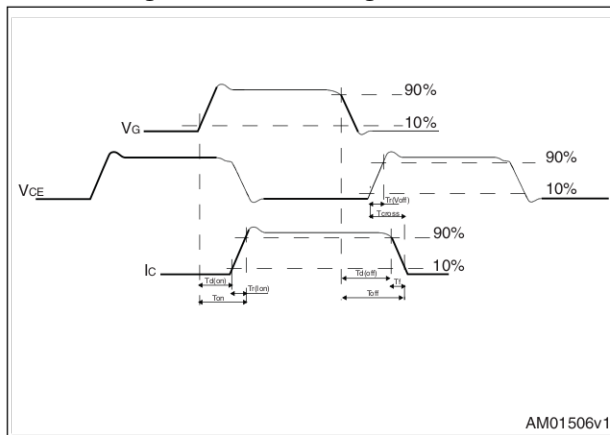
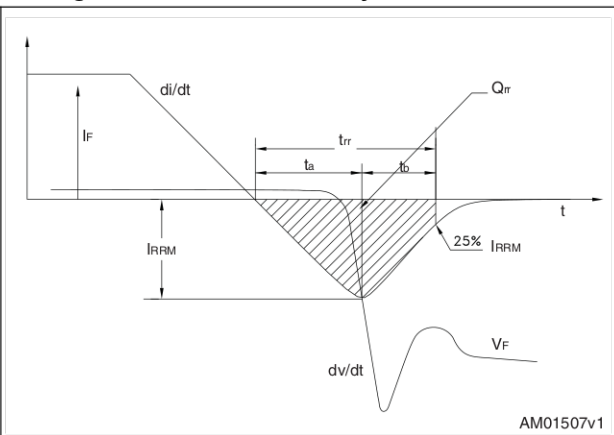

Figure 31. Diode recovery time waveform



4 Package mechanical data

In order to meet environmental requirements, ST offers these devices in different grades of ECOPACK® packages, depending on their level of environmental compliance. ECOPACK® specifications, grade definitions and product status are available at: www.st.com. ECOPACK is an ST trademark.

Table 8. TO-220 type A mechanical data

| Dim. | mm | | |
|------|-------|-------|-------|
| | Min. | Typ. | Max. |
| A | 4.40 | | 4.60 |
| b | 0.61 | | 0.88 |
| b1 | 1.14 | | 1.70 |
| c | 0.48 | | 0.70 |
| D | 15.25 | | 15.75 |
| D1 | | 1.27 | |
| E | 10 | | 10.40 |
| e | 2.40 | | 2.70 |
| e1 | 4.95 | | 5.15 |
| F | 1.23 | | 1.32 |
| H1 | 6.20 | | 6.60 |
| J1 | 2.40 | | 2.72 |
| L | 13 | | 14 |
| L1 | 3.50 | | 3.93 |
| L20 | | 16.40 | |
| L30 | | 28.90 | |
| ØP | 3.75 | | 3.85 |
| Q | 2.65 | | 2.95 |

Figure 32. TO-220 type A drawing

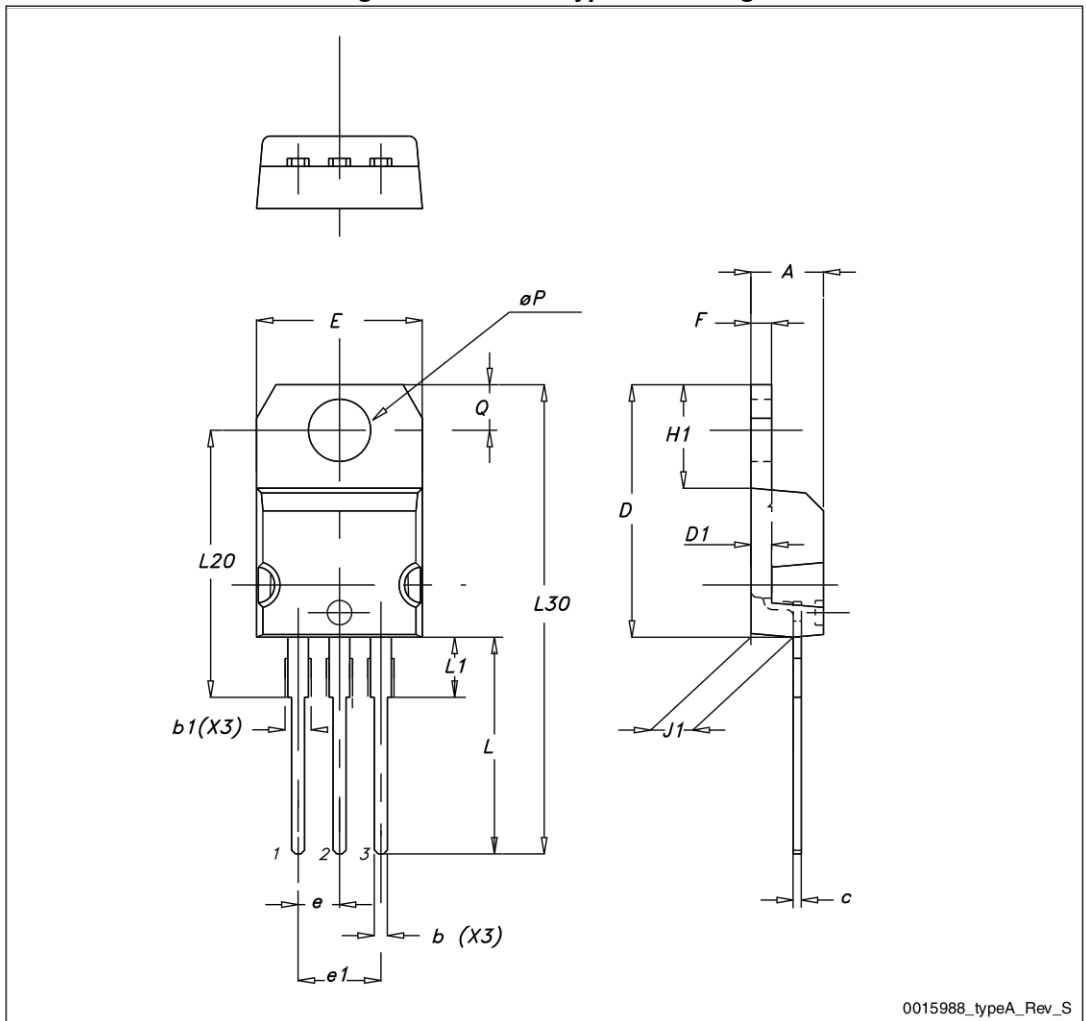

0015988_typeA_Rev_S

Table 9. D²PAK (TO-263) mechanical data

| Dim. | mm | | |
|------|------|------|-------|
| | Min. | Typ. | Max. |
| A | 4.40 | | 4.60 |
| A1 | 0.03 | | 0.23 |
| b | 0.70 | | 0.93 |
| b2 | 1.14 | | 1.70 |
| c | 0.45 | | 0.60 |
| c2 | 1.23 | | 1.36 |
| D | 8.95 | | 9.35 |
| D1 | 7.50 | | |
| E | 10 | | 10.40 |
| E1 | 8.50 | | |
| e | | 2.54 | |
| e1 | 4.88 | | 5.28 |
| H | 15 | | 15.85 |
| J1 | 2.49 | | 2.69 |
| L | 2.29 | | 2.79 |
| L1 | 1.27 | | 1.40 |
| L2 | 1.30 | | 1.75 |
| R | | 0.4 | |
| V2 | 0° | | 8° |

Figure 33. D²PAK (TO-263) drawing

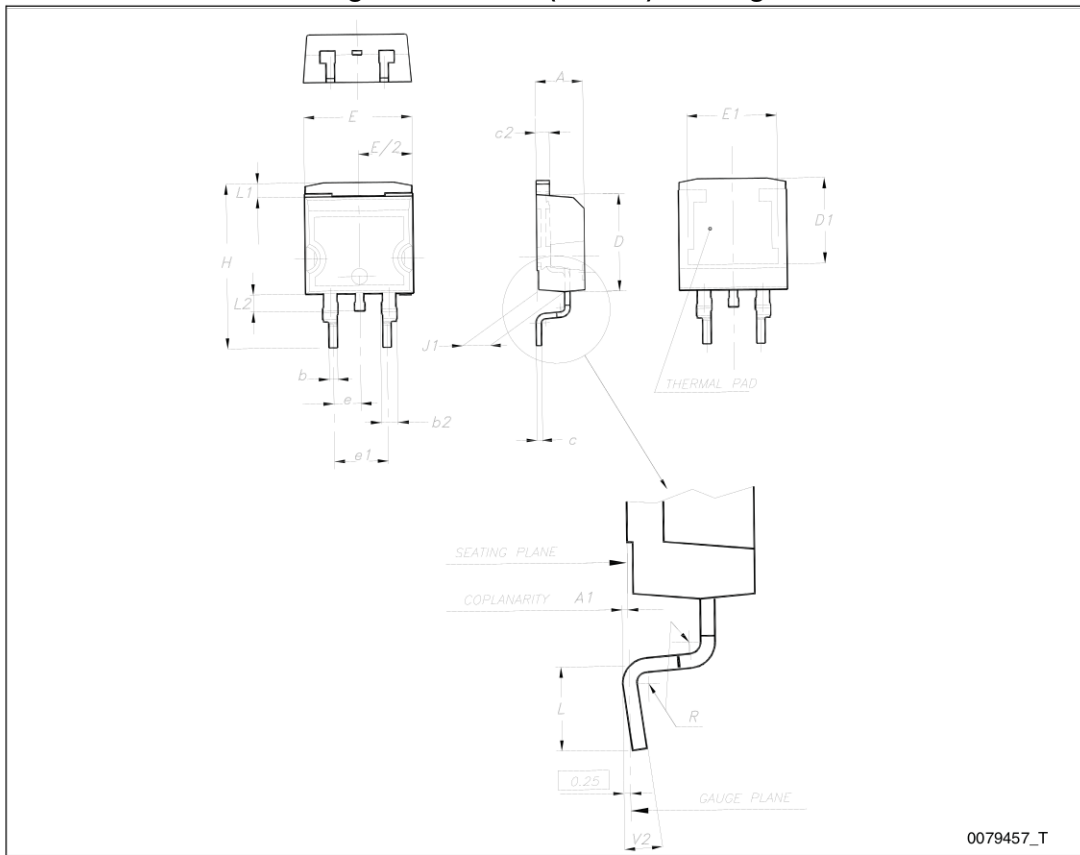
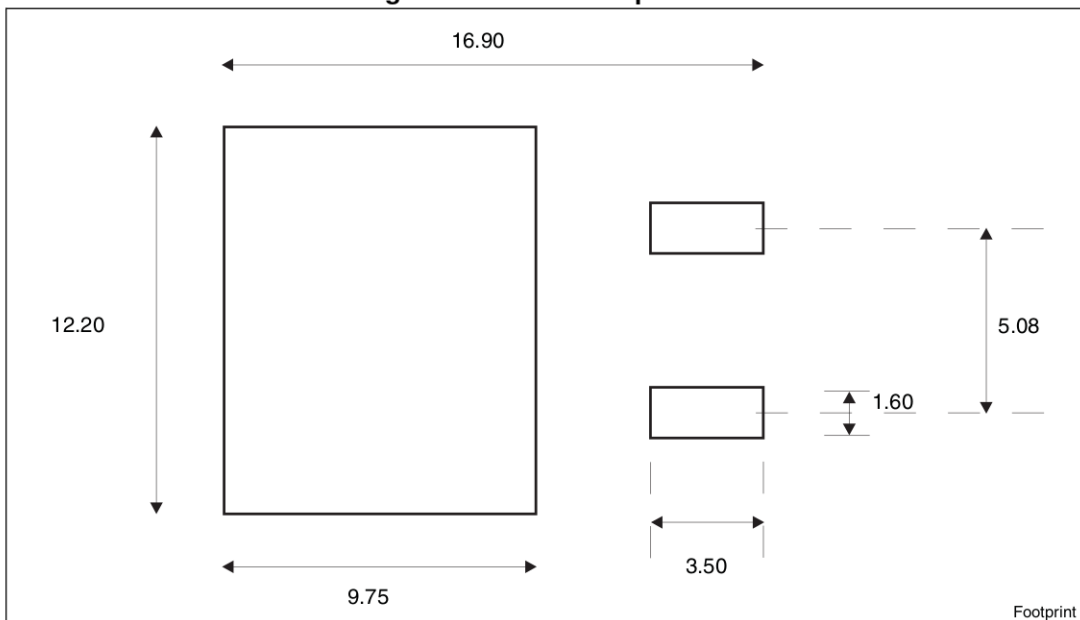

Figure 34. D²PAK footprint (a)



a. All dimension are in millimeters

Table 10. TO-247 mechanical data

| Dim. | mm. | | |
|------|-------|-------|-------|
| | Min. | Typ. | Max. |
| A | 4.85 | | 5.15 |
| A1 | 2.20 | | 2.60 |
| b | 1.0 | | 1.40 |
| b1 | 2.0 | | 2.40 |
| b2 | 3.0 | | 3.40 |
| c | 0.40 | | 0.80 |
| D | 19.85 | | 20.15 |
| E | 15.45 | | 15.75 |
| e | 5.30 | 5.45 | 5.60 |
| L | 14.20 | | 14.80 |
| L1 | 3.70 | | 4.30 |
| L2 | | 18.50 | |
| ØP | 3.55 | | 3.65 |
| ØR | 4.50 | | 5.50 |
| S | 5.30 | 5.50 | 5.70 |

Figure 35. TO-247 drawing

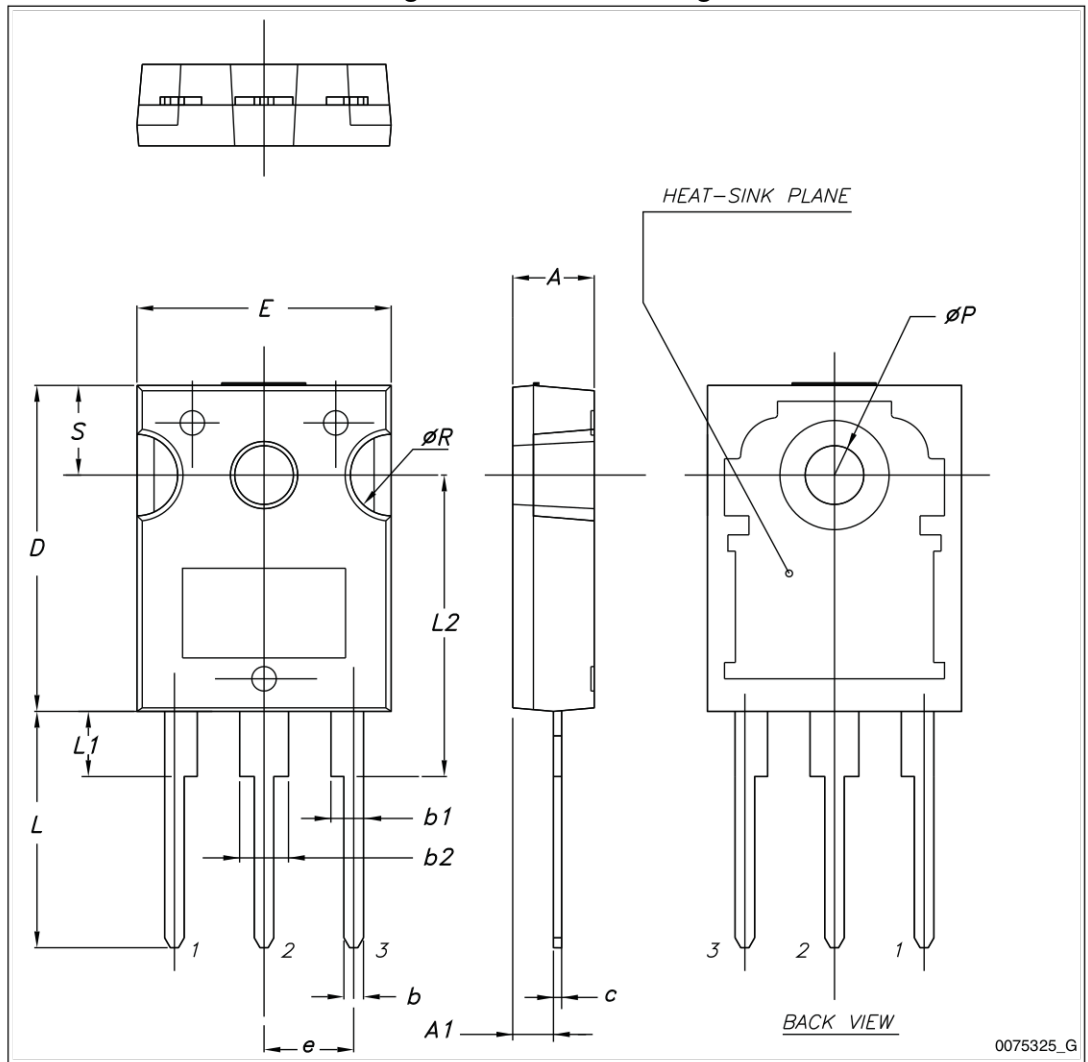
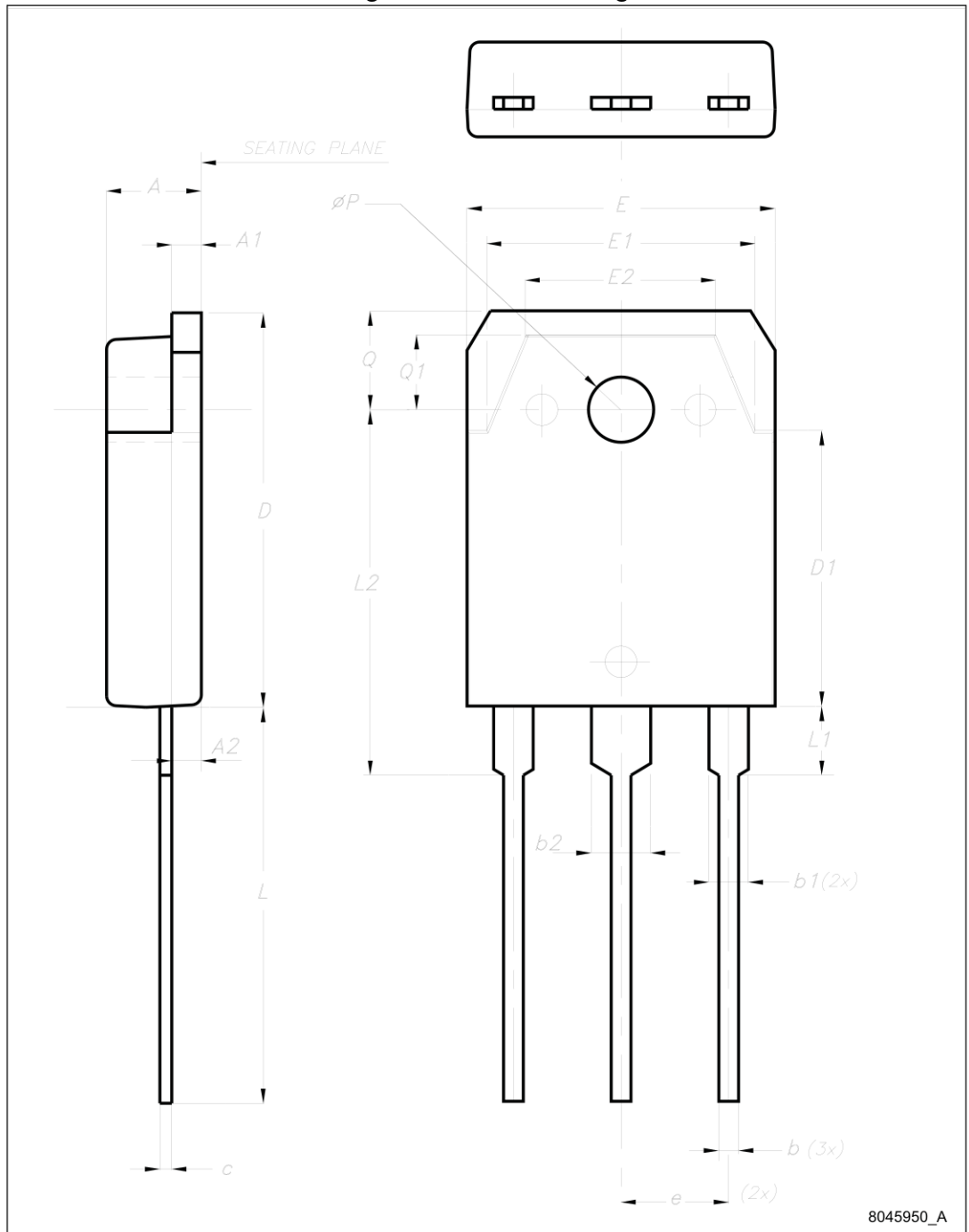

Table 11. TO-3P mechanical data

| Dim. | mm | | |
|------|-------|-------|-------|
| | Min. | Typ. | Max. |
| A | 4.60 | | 5 |
| A1 | 1.45 | 1.50 | 1.65 |
| A2 | 1.20 | 1.40 | 1.60 |
| b | 0.80 | 1 | 1.20 |
| b1 | 1.80 | | 2.20 |
| b2 | 2.80 | | 3.20 |
| c | 0.55 | 0.60 | 0.75 |
| D | 19.70 | 19.90 | 20.10 |
| D1 | | 13.90 | |
| E | 15.40 | | 15.80 |
| E1 | | 13.60 | |
| E2 | | 9.60 | |
| e | 5.15 | 5.45 | 5.75 |
| L | 19.50 | 20 | 20.50 |
| L1 | | 3.50 | |
| L2 | 18.20 | 18.40 | 18.60 |
| øP | 3.10 | | 3.30 |
| Q | | 5 | |
| Q1 | | 3.80 | |

Figure 36. TO-3P drawing



5 Packing mechanical data

Table 12. D²PAK (TO-263) tape and reel mechanical data

| Tape | | | Reel | | |
|------|------|------|----------|------|------|
| Dim. | mm | | Dim. | mm | |
| | Min. | Max. | | Min. | Max. |
| A0 | 10.5 | 10.7 | A | | 330 |
| B0 | 15.7 | 15.9 | B | 1.5 | |
| D | 1.5 | 1.6 | C | 12.8 | 13.2 |
| D1 | 1.59 | 1.61 | D | 20.2 | |
| E | 1.65 | 1.85 | G | 24.4 | 26.4 |
| F | 11.4 | 11.6 | N | 100 | |
| K0 | 4.8 | 5.0 | T | | 30.4 |
| P0 | 3.9 | 4.1 | | | |
| P1 | 11.9 | 12.1 | Base qty | | 1000 |
| P2 | 1.9 | 2.1 | Bulk qty | | 1000 |
| R | 50 | | | | |
| T | 0.25 | 0.35 | | | |
| W | 23.7 | 24.3 | | | |

Figure 37. Tape

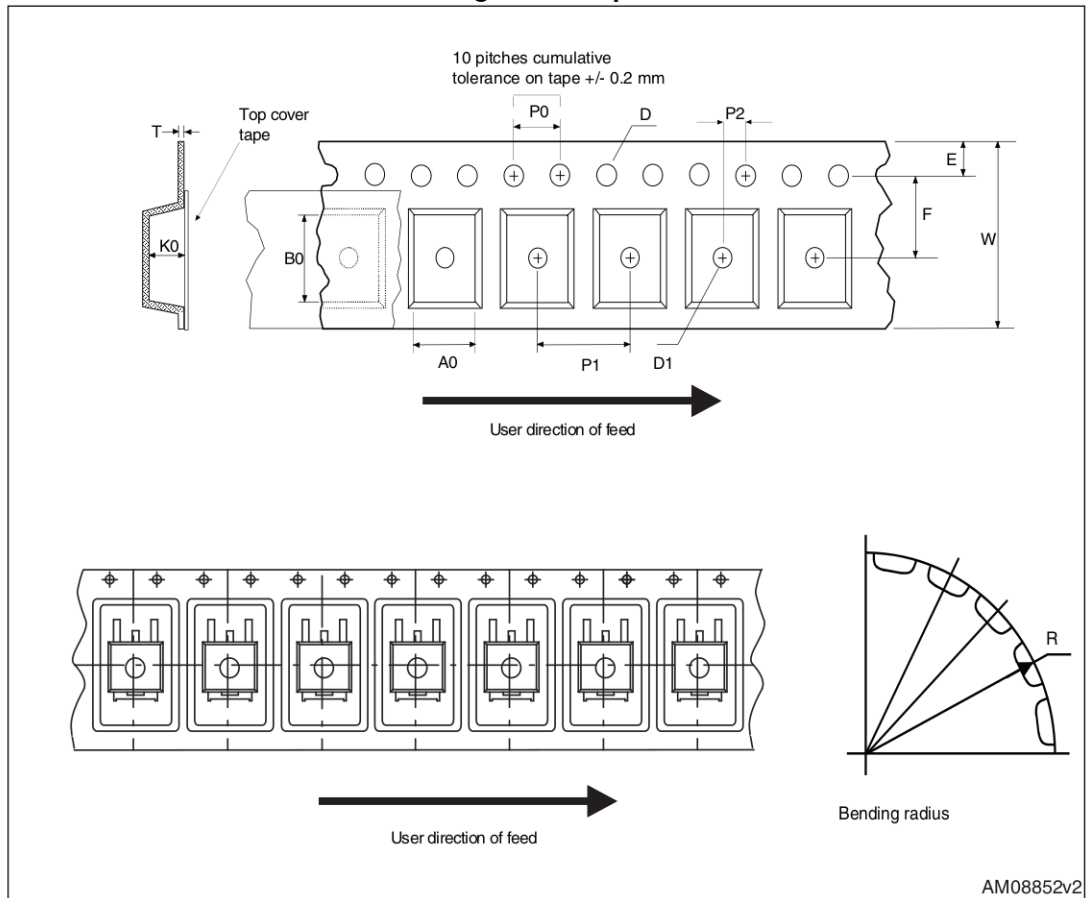
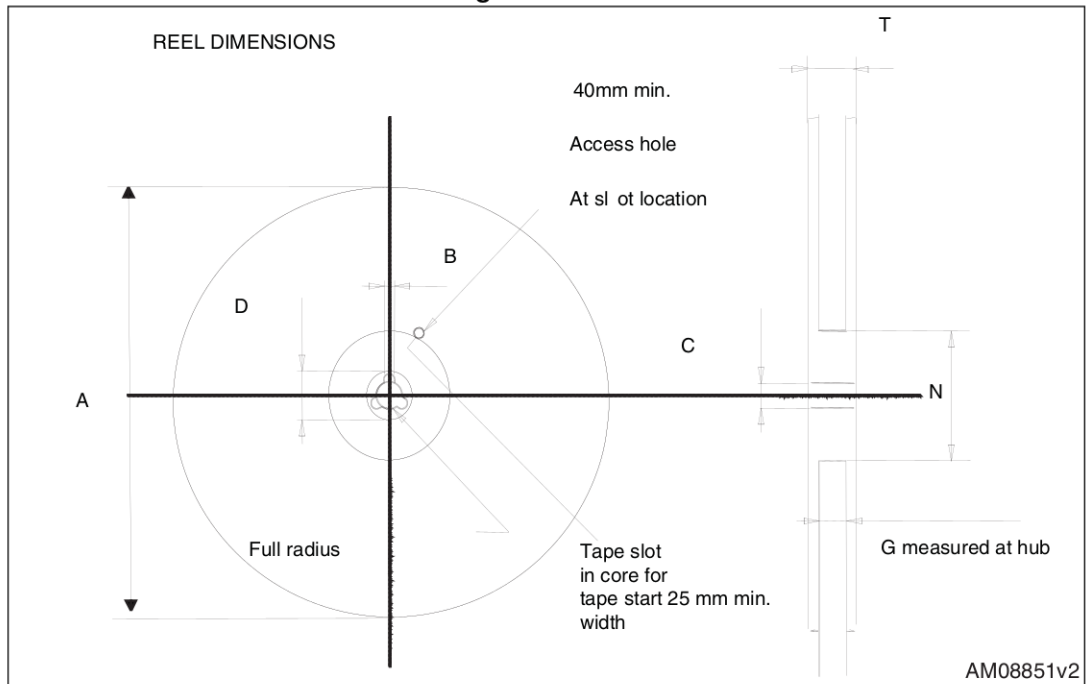

Figure 38. Reel



6 Revision history

Table 13. Document revision history

| Date | Revision | Changes |
|-------------|----------|--|
| 12-Mar-2013 | 1 | Initial release. |
| 16-May-2013 | 2 | Document status promoted from preliminary data to production data. Added: <ul style="list-style-type: none">– New root part numbers STGB20V60DF and STGP20V60DF Table 1 on page 1.– Package mechanical data Table 8 on page 12, Table 9 on page 14, Figure 32 on page 13 and Figure 33 on page 15.– Section 2.1: Electrical characteristics (curves) on page 6. |
| 04-Jun-2013 | 3 | Added maximum value for $V_{GE(th)}$ and V_F in Table 4: Static characteristics . |

Please Read Carefully:

Information in this document is provided solely in connection with ST products. STMicroelectronics NV and its subsidiaries ("ST") reserve the right to make changes, corrections, modifications or improvements, to this document, and the products and services described herein at any time, without notice.

All ST products are sold pursuant to ST's terms and conditions of sale.

Purchasers are solely responsible for the choice, selection and use of the ST products and services described herein, and ST assumes no liability whatsoever relating to the choice, selection or use of the ST products and services described herein.

No license, express or implied, by estoppel or otherwise, to any intellectual property rights is granted under this document. If any part of this document refers to any third party products or services it shall not be deemed a license grant by ST for the use of such third party products or services, or any intellectual property contained therein or considered as a warranty covering the use in any manner whatsoever of such third party products or services or any intellectual property contained therein.

UNLESS OTHERWISE SET FORTH IN ST'S TERMS AND CONDITIONS OF SALE ST DISCLAIMS ANY EXPRESS OR IMPLIED WARRANTY WITH RESPECT TO THE USE AND/OR SALE OF ST PRODUCTS INCLUDING WITHOUT LIMITATION IMPLIED WARRANTIES OF MERCHANTABILITY, FITNESS FOR A PARTICULAR PURPOSE (AND THEIR EQUIVALENTS UNDER THE LAWS OF ANY JURISDICTION), OR INFRINGEMENT OF ANY PATENT, COPYRIGHT OR OTHER INTELLECTUAL PROPERTY RIGHT.

ST PRODUCTS ARE NOT AUTHORIZED FOR USE IN WEAPONS. NOR ARE ST PRODUCTS DESIGNED OR AUTHORIZED FOR USE IN: (A) SAFETY CRITICAL APPLICATIONS SUCH AS LIFE SUPPORTING, ACTIVE IMPLANTED DEVICES OR SYSTEMS WITH PRODUCT FUNCTIONAL SAFETY REQUIREMENTS; (B) AERONAUTIC APPLICATIONS; (C) AUTOMOTIVE APPLICATIONS OR ENVIRONMENTS, AND/OR (D) AEROSPACE APPLICATIONS OR ENVIRONMENTS. WHERE ST PRODUCTS ARE NOT DESIGNED FOR SUCH USE, THE PURCHASER SHALL USE PRODUCTS AT PURCHASER'S SOLE RISK, EVEN IF ST HAS BEEN INFORMED IN WRITING OF SUCH USAGE, UNLESS A PRODUCT IS EXPRESSLY DESIGNATED BY ST AS BEING INTENDED FOR "AUTOMOTIVE, AUTOMOTIVE SAFETY OR MEDICAL" INDUSTRY DOMAINS ACCORDING TO ST PRODUCT DESIGN SPECIFICATIONS. PRODUCTS FORMALLY ESCC, QML OR JAN QUALIFIED ARE DEEMED SUITABLE FOR USE IN AEROSPACE BY THE CORRESPONDING GOVERNMENTAL AGENCY.

Resale of ST products with provisions different from the statements and/or technical features set forth in this document shall immediately void any warranty granted by ST for the ST product or service described herein and shall not create or extend in any manner whatsoever, any liability of ST.

ST and the ST logo are trademarks or registered trademarks of ST in various countries.

Information in this document supersedes and replaces all information previously supplied.

The ST logo is a registered trademark of STMicroelectronics. All other names are the property of their respective owners.

© 2013 STMicroelectronics - All rights reserved

STMicroelectronics group of companies

Australia - Belgium - Brazil - Canada - China - Czech Republic - Finland - France - Germany - Hong Kong - India - Israel - Italy - Japan - Malaysia - Malta - Morocco - Philippines - Singapore - Spain - Sweden - Switzerland - United Kingdom - United States of America

www.st.com

