

High temperature 12 A SCRs

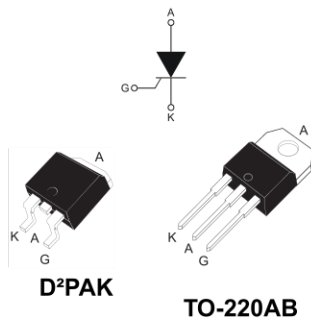

Features

- High junction temperature: $T_j = 150\text{ }^\circ\text{C}$
- Medium current SCRs
- High noise immunity up to $150\text{ }^\circ\text{C}$
- RoHS (2002/95/EC) compliant
- $600\text{ V } V_{\text{DRM}}, V_{\text{RRM}}$

Applications

- General purpose AC line load switching
- Motor control circuits
- Small home appliances
- Lighting
- Inrush current limiting circuits
- Overvoltage crowbar protection

Description

Available in standard gate triggering levels, the TN1205H SCR series has very high switching capability up to a junction temperature of $150\text{ }^\circ\text{C}$.

These products fit all modes of control found in applications such as overvoltage crowbar protection, motor control circuits in power tools and kitchen aids, inrush current limiting circuits, capacitive discharge ignition and voltage regulation circuits.

These products are particularly adapted for use in areas where the ambient temperature is high or the ventilation low, or where an increase of power density is required.

Through-hole or surface-mount packages provide performance in a limited space area.

Product status link	
TN1205H	
Product summary	
$V_{\text{DRM}}, V_{\text{RRM}}$	600 V
I_{GT}	2 to 5 mA

1 Characteristics

Table 1. Absolute maximum ratings (limiting values)

Symbol	Parameter			Value	Unit	
$I_{T(RMS)}$	RMS on-state current (180° conduction angle))	D ² PAK, TO-220AB	$T_c = 136\text{ °C}$	12	A	
$I_{T(AV)}$	Average on-state current (180° conduction angle)			7.6		
I_{TSM}	Non repetitive surge peak on-state current		$T_j = 25\text{ °C}$	$t_p = 8.3\text{ ms}$	126	A
				$t_p = 10\text{ ms}$	120	
I^2t	I^2t value for fusing		$t_p = 10\text{ ms}$	72	A ² s	
di/dt	Critical rate of rise of on-state current, $I_G = 2 \times I_{GT}$, $t_r \leq 100\text{ ns}$, $F = 60\text{ Hz}$		$T_j = 150\text{ °C}$	100	A/ μ s	
V_{DSM}/V_{RSM}	Non Repetitive peak off-state voltage		$t_p = 10\text{ ms}$	$V_{DRM}/V_{RRM} + 100$	V	
I_{GM}	Peak gate current	$t_p = 20\text{ }\mu$ s	$T_j = 150\text{ °C}$	4	A	
$P_{G(AV)}$	Average gate power dissipation		$T_j = 150\text{ °C}$	1	W	
V_{RGM}	Maximum peak reverse gate voltage			5	V	
T_{stg}	Storage temperature range			-40 to +150	°C	
T_j	Operating junction temperature range			-40 to +150	°C	
T_L	Maximum lead temperature for soldering during 10 s.			260	°C	

Table 2. Electrical characteristics ($T_j = 25\text{ °C}$, unless otherwise specified)

Symbol	Test conditions			Value	Unit
$I_{GT}^{(1)}$	$V_D = 12\text{ V}$, $R_L = 33\text{ }\Omega$		Max.	2	mA
			Max.	5	
V_{GT}			Max.	1.3	V
V_{GD}	$V_D = V_{DRM}$, $R_L = 3.3\text{ k}\Omega$		Min.	0.2	V
I_L	$I_G = 1.2 \times I_{GT}$		Max.	40	mA
$I_H^{(2)}$	$I_T = 500\text{ mA}$, gate open		Max.	20	mA
$dV/dt^{(2)}$	$V_D = 67\% V_{DRM}$, gate open	$T_j = 125\text{ °C}$	Min.	200	V/ μ s
		$T_j = 150\text{ °C}$		100	
t_{gt}	$I_{TM} = 40\text{ A}$, $V_D = 500\text{ V}$, $I_G = 100\text{ mA}$, $di_G/dt = 5\text{ A}/\mu$ s		Typ.	1.9	μ s
t_q	$V_{DM} = 335\text{ V}$, $T_j = 125\text{ °C}$, $I_{TM} = 20\text{ A}$, $V_R = 25\text{ V}$, $(di_T/dt)_{Max} = 30\text{ A}/\mu$ s, $dV_D/dt = 50\text{ V}/\mu$ s, $R_{GK} = 100\text{ }\Omega$		Typ.	65	μ s

1. Minimum I_{GT} is guaranteed at 20% of I_{GT} max.
2. For both polarities of A2 referenced to A1.

Table 3. Static characteristics

Symbol	Test conditions		Max. value	Unit
V_T	$I_{TM} = 24 \text{ A}$, $t_p = 380 \mu\text{s}$	$T_j = 25 \text{ }^\circ\text{C}$	1.6	V
V_{TD}	Threshold voltage	$T_j = 150 \text{ }^\circ\text{C}$	0.80	V
R_D	Dynamic resistance	$T_j = 150 \text{ }^\circ\text{C}$	30	m Ω
I_{DRM}/I_{RRM}	$V_{DRM} = V_{RRM}$	$T_j = 25 \text{ }^\circ\text{C}$	5	μA
		$T_j = 125 \text{ }^\circ\text{C}$	1	mA
		$T_j = 150 \text{ }^\circ\text{C}$	3	mA

Table 4. Thermal resistance

Symbol	Parameter		Value	Unit
$R_{th(j-c)}$	Junction to case (DC)		1.3	$^\circ\text{C}/\text{W}$
$R_{th(j-a)}$	Junction to ambient DC ($S_{cu} = 1 \text{ cm}^2$)	D ² PAK	45	$^\circ\text{C}/\text{W}$
		TO-220AB	60	

1.1 Characteristics curves

Figure 1. Maximum power dissipation versus on-state RMS current

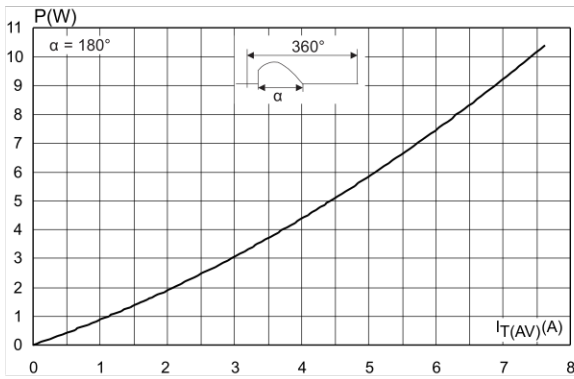

Figure 2. Average and DC on-state current versus case temperature

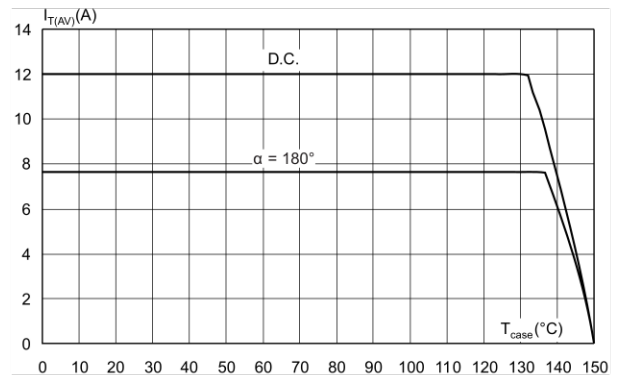

Figure 3. Average and DC on-state current versus ambient temperature

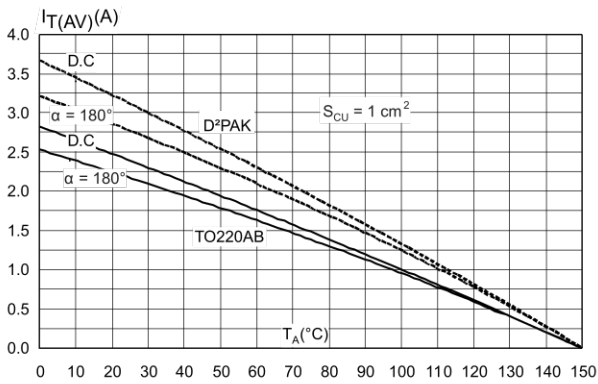

Figure 4. Variation of thermal impedance versus pulse duration

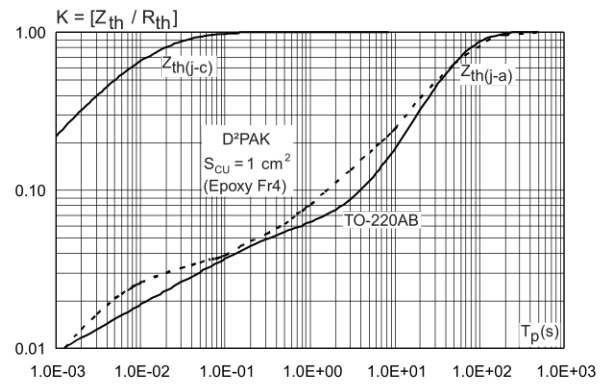

Figure 5. Relative variation of I_{GT} , V_{GT} , I_H , I_L versus junction temperature (typical values)

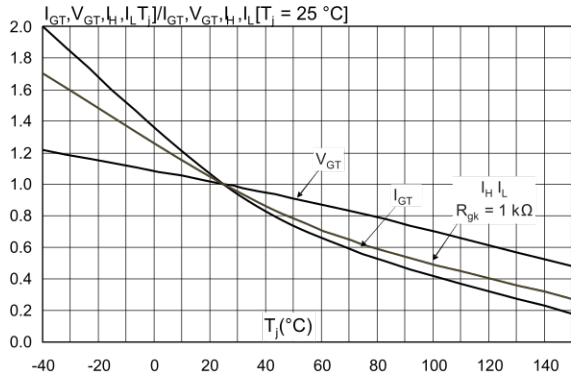

Figure 6. Relative variation of static dV/dt immunity versus junction temperature (typical values)

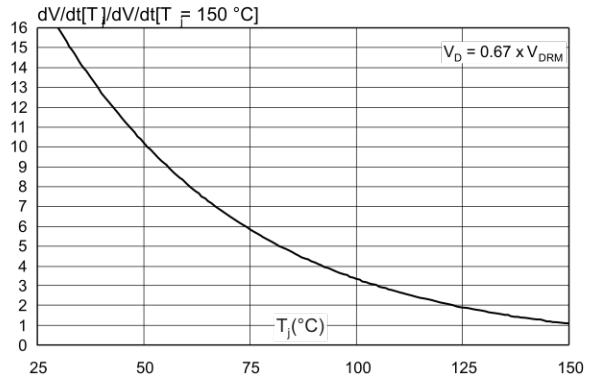

Figure 7. Surge peak on-state current versus number of cycles

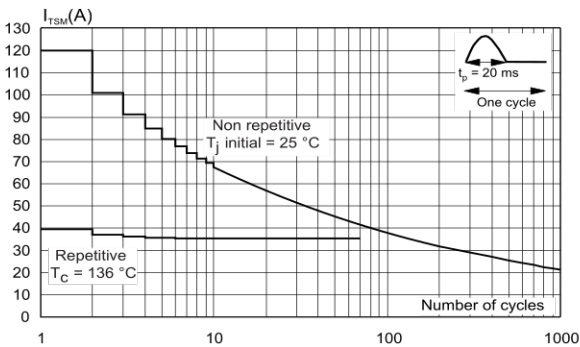

Figure 8. Non repetitive surge peak on-state current and corresponding value of I^2t versus sinusoidal pulse width

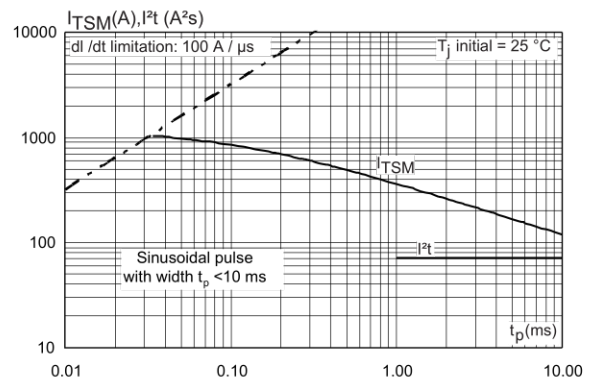

Figure 9. On-state characteristics (maximum values)

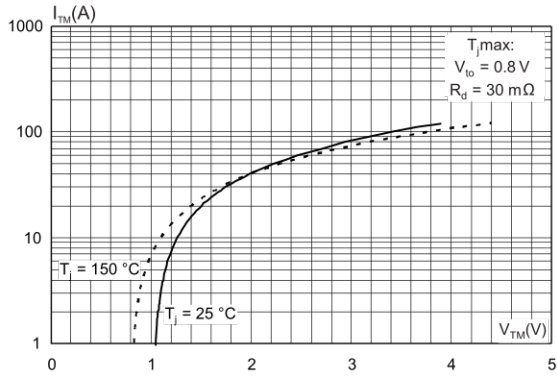

Figure 10. Relative variation of leakage current versus junction temperature for different values of blocking voltage

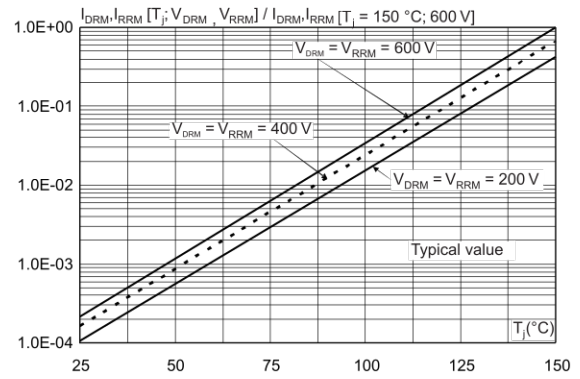
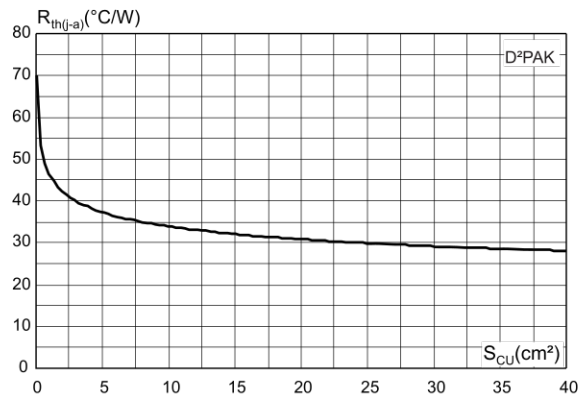

Figure 11. Thermal resistance junction to ambient versus copper surface under tab (D²PAK, printed circuit board FR4, copper thickness: 35 μm)



2 Package information

In order to meet environmental requirements, ST offers these devices in different grades of **ECOPACK** packages, depending on their level of environmental compliance. ECOPACK specifications, grade definitions and product status are available at: www.st.com. ECOPACK is an ST trademark.

2.1 D²PAK package information

- **ECOPACK2** compliant
- Lead-free package leads finishing
- Molding compound resin is halogen-free and meets UL94 flammability standard level V0

Figure 12. D²PAK package outline

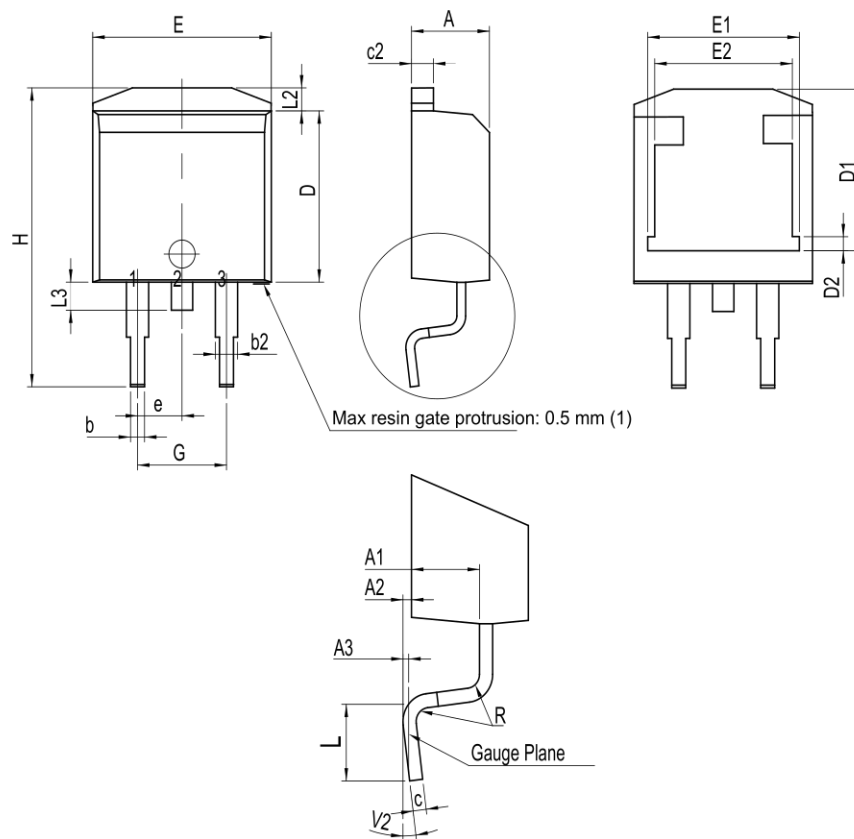

(1) Resin gate is accepted in each of position shown on the drawing, or their symmetrical.

Table 5. D²PAK package mechanical data

Ref.	Dimensions					
	Millimeters			Inches ⁽¹⁾		
	Min.	Typ.	Max.	Min.	Typ.	Max.
A	4.30		4.60	0.1693		0.1811
A1	2.49		2.69	0.0980		0.1059
A2	0.03		0.23	0.0012		0.0091
A3		0.25			0.0098	
b	0.70		0.93	0.0276		0.0366
b2	1.25		1.7	0.0492		0.0669
c	0.45		0.60	0.0177		0.0236
c2	1.21		1.36	0.0476		0.0535
D	8.95		9.35	0.3524		0.3681
D1	7.50		8.00	0.2953		0.3150
D2	1.30		1.70	0.0512		0.0669
e	2.54			0.10000		
E	10.00		10.28	0.3937		0.4047
E1	8.30		8.70	0.3268		0.3425
E2	6.85		7.25	0.2697		0.2854
G	4.88		5.28	0.1921		0.2079
H	15		15.85	0.5906		0.6240
L	1.78		2.28	0.0701		0.0898
L2	1.19		1.40	0.0460		0.0551
L3	1.40		1.75	0.0551		0.0689
R		0.40			0.0157	
V2 ⁽²⁾	0°		8°	0°		8°

1. Dimensions in inches are given for reference only

2. Degrees

Figure 13. D²PAK recommended footprint (dimensions are in mm)

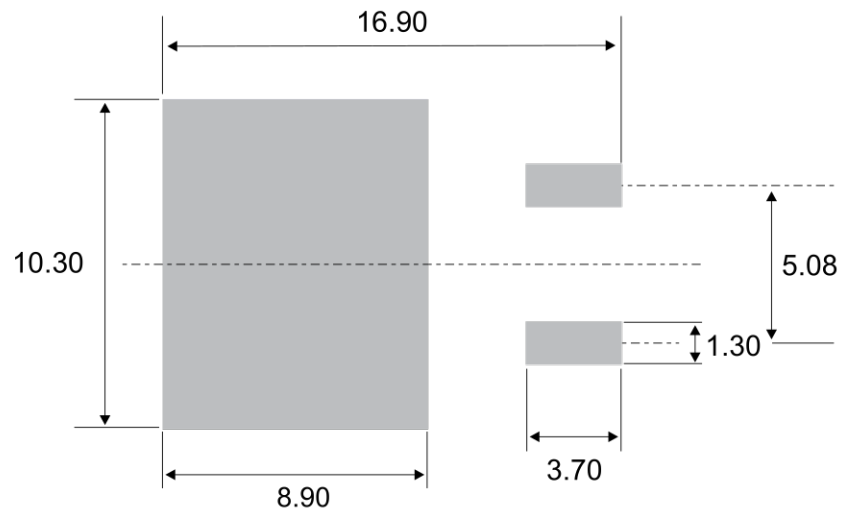
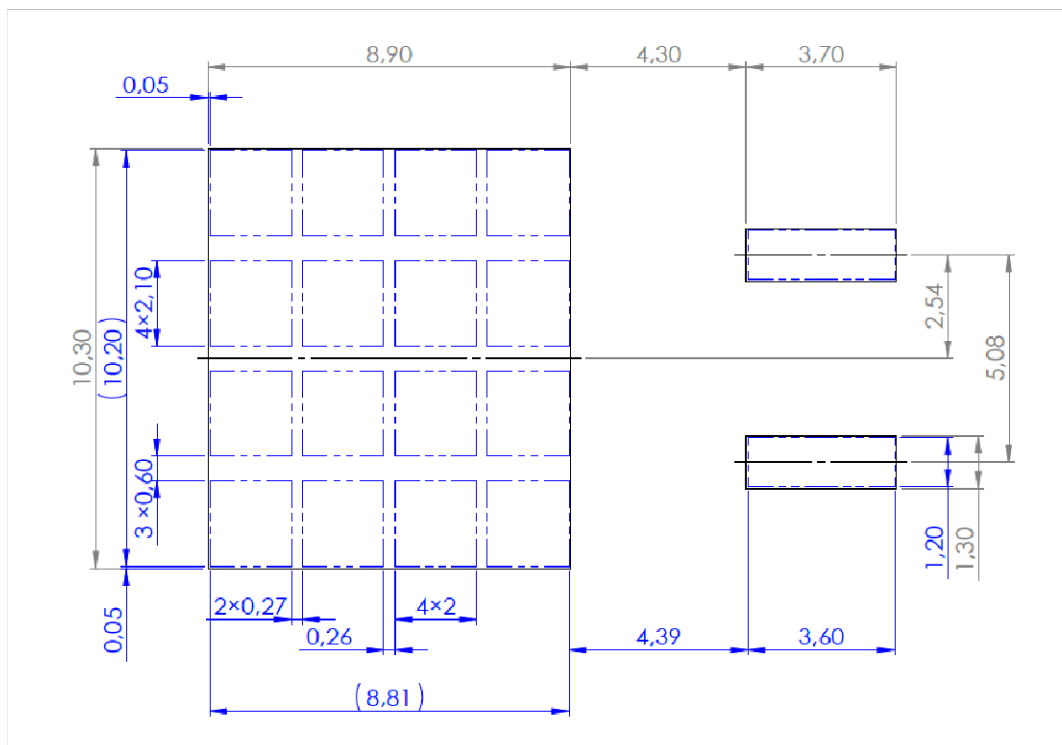

Figure 14. D²PAK stencil definitions (dimensions are in mm)



2.2 TO-220AB package information

- Molding compound resin is halogen-free and meets flammability standard UL94 level 0
- Lead-free package leads finishing
- ECOPACK2 compliant
- Recommended torque: 0.4 to 0.6 N.m

Figure 15. TO-220AB package outline

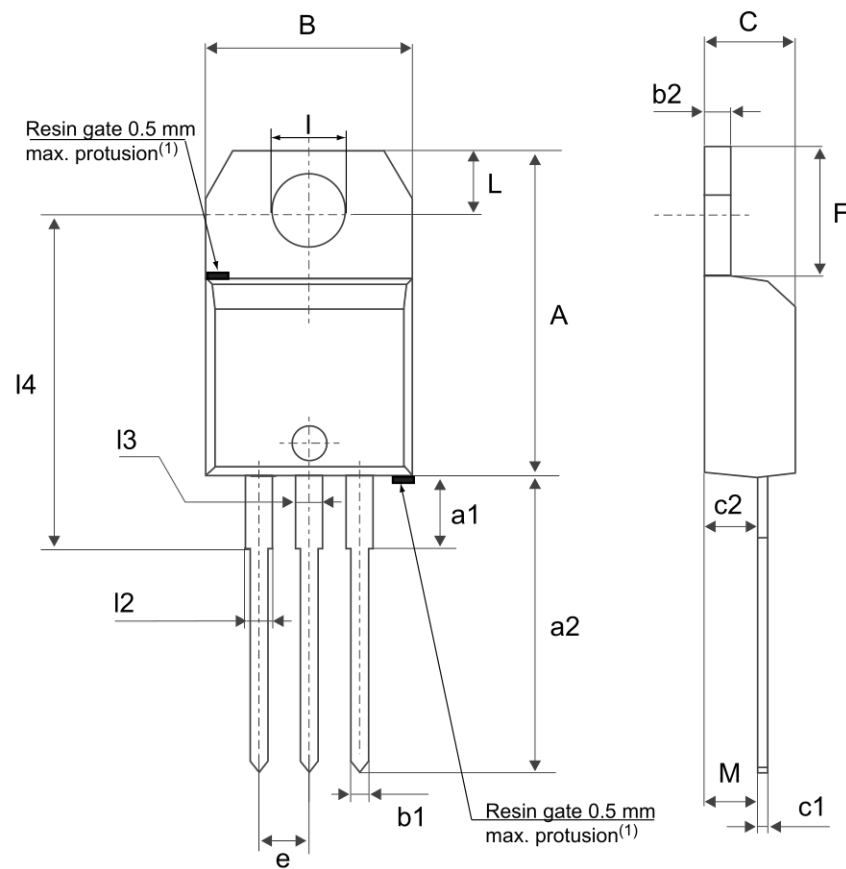

(1) Resin gate position accepted in one of the two positions or in the symmetrical opposites.

Table 6. TO-220AB package mechanical data

Ref.	Dimensions					
	Millimeters			Inches ⁽¹⁾		
	Min.	Typ.	Max.	Min.	Typ.	Max.
A	15.20		15.90	0.5984		0.6260
a1		3.75			0.1476	
a2	13.00		14.00	0.5118		0.5512
B	10.00		10.40	0.3937		0.4094
b1	0.61		0.88	0.0240		0.0346
b2	1.23		1.32	0.0484		0.0520
C	4.40		4.60	0.1732		0.1811
c1	0.49		0.70	0.0193		0.0276
c2	2.40		2.72	0.0945		0.1071
e	2.40		2.70	0.0945		0.1063
F	6.20		6.60	0.2441		0.2598
l	3.73		3.88	0.1469		0.1528
L	2.65		2.95	0.1043		0.1161
l2	1.14		1.70	0.0449		0.0669
l3	1.14		1.70	0.0449		0.0669
l4	15.80	16.40	16.80	0.6220	0.6457	0.6614
M		2.6			0.1024	

1. Inch dimensions are for reference only.

3 Ordering information

Figure 16. Ordering information scheme

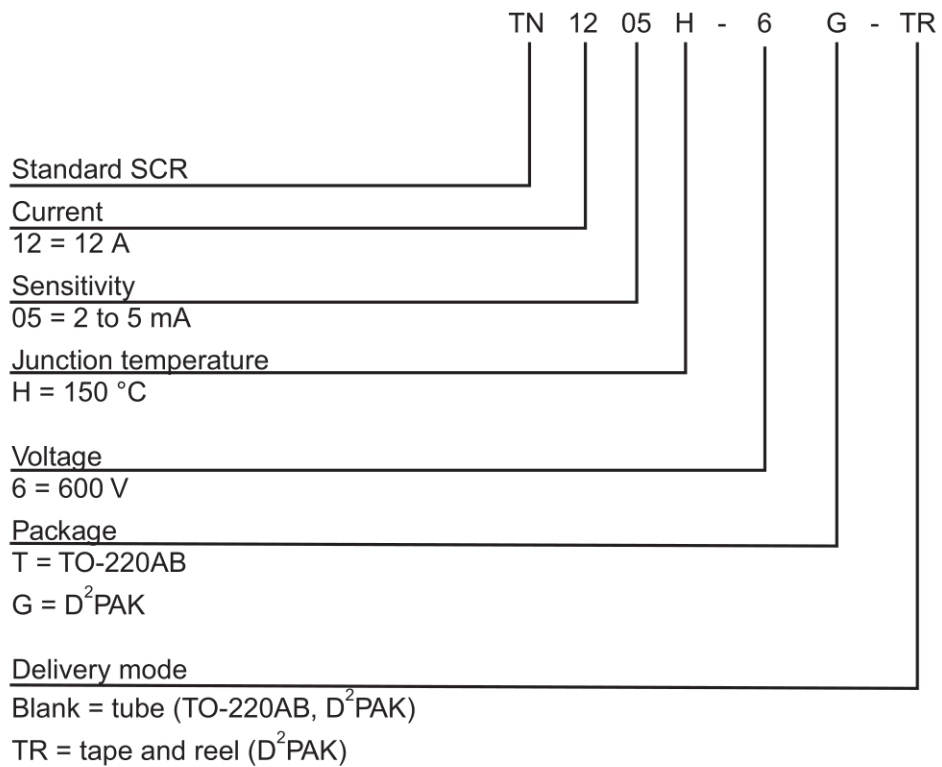

Table 7. Ordering information

Order code	Marking	Package	Weight	Base qty.	Delivery mode
TN1205H-6T	TN1205H6T	TO-220AB	2.0 g	50	Tube
TN1205H-6G	TN1205H6G	D ² PAK	1.5 g	50	Tube
TN1205H-6G-TR	TN1205H6G	D ² PAK	1.5 g	1000	Tape and reel

Revision history

Table 8. Document revision history

Date	Version	Changes
17-Feb-2011	1	First issue.
26-Sep-2011	2	Corrected typographical error in Features and Description.
17-Jan-2012	3	Updated units for t_{gt} in Table 3.
26-Apr-2012	4	Moved junction temperature to top of features list. Description reworded for readability. No technical changes.
24-Sep-2020	5	Updated Table 2. Electrical characteristics ($T_j = 25\text{ }^\circ\text{C}$, unless otherwise specified).

IMPORTANT NOTICE – PLEASE READ CAREFULLY

STMicroelectronics NV and its subsidiaries (“ST”) reserve the right to make changes, corrections, enhancements, modifications, and improvements to ST products and/or to this document at any time without notice. Purchasers should obtain the latest relevant information on ST products before placing orders. ST products are sold pursuant to ST’s terms and conditions of sale in place at the time of order acknowledgement.

Purchasers are solely responsible for the choice, selection, and use of ST products and ST assumes no liability for application assistance or the design of Purchasers’ products.

No license, express or implied, to any intellectual property right is granted by ST herein.

Resale of ST products with provisions different from the information set forth herein shall void any warranty granted by ST for such product.

ST and the ST logo are trademarks of ST. For additional information about ST trademarks, please refer to www.st.com/trademarks. All other product or service names are the property of their respective owners.

Information in this document supersedes and replaces information previously supplied in any prior versions of this document.

© 2020 STMicroelectronics – All rights reserved