

Wide bandwidth single JFET operational amplifiers

Features

- Internally adjustable input offset voltage
- Low power consumption
- Wide common-mode (up to V_{CC^+}) and differential voltage range
- Low input bias and offset current
- Output short-circuit protection
- High input impedance JFET input stage
- Internal frequency compensation
- Latch up free operation
- High slew rate 16 V/ μ s (typical)

Description

These circuits are high speed JFET input single operational amplifiers incorporating well matched, high voltage JFET and bipolar transistors in a monolithic integrated circuit.

The devices feature high slew rates, low input bias and offset currents, and low offset voltage temperature coefficient.

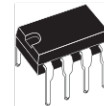

N
DIP8
(Plastic package)



D
SO-8
(Plastic micro package)

Pin connections
(top view)

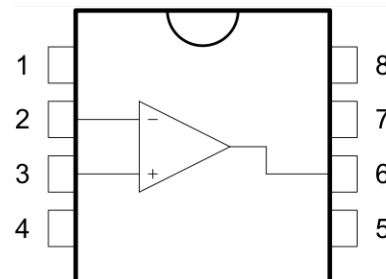

- 1 - Offset null 1
- 2 - Inverting input
- 3 - Non-inverting input
- 4 - V_{CC^-}
- 5 - Offset null 2
- 6 - Output
- 7 - V_{CC^+}
- 8 - N.C.

1 Schematics

Figure 1. Schematic diagram

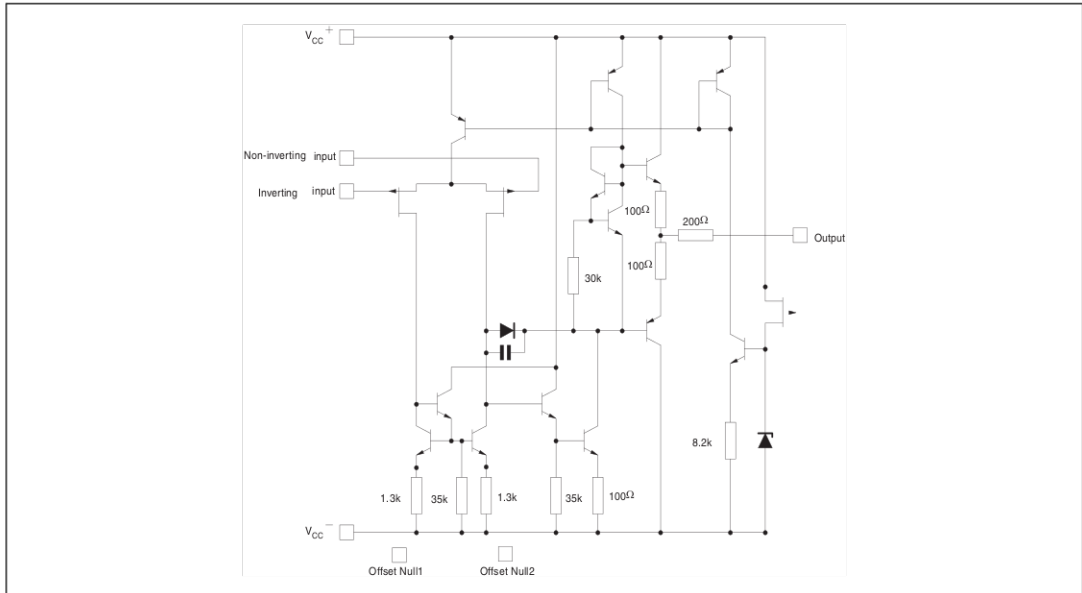
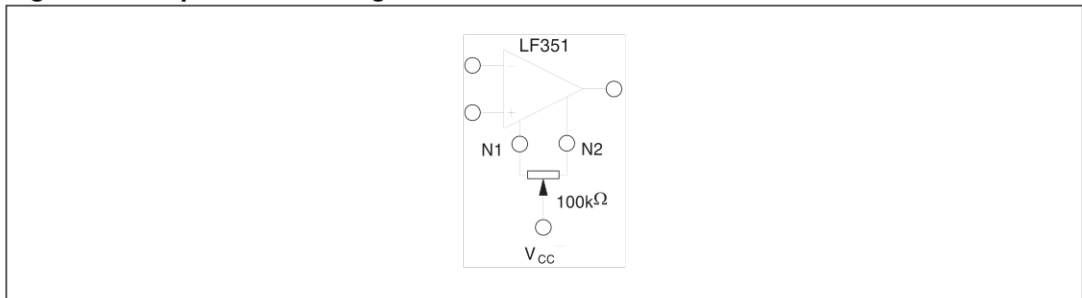

Figure 2. Input offset voltage null circuit



2 Absolute maximum ratings and operating conditions

Table 1. Absolute maximum ratings

Symbol	Parameter	Value	Unit
V_{CC}	Supply voltage ⁽¹⁾	±18	V
V_i	Input voltage ⁽²⁾	±15	V
V_{id}	Differential input voltage ⁽³⁾	±30	V
R_{thja}	Thermal resistance junction to ambient ⁽⁴⁾		
	SO-8 DIP8	125 85	°C/W
R_{thjc}	Thermal resistance junction to case ⁽⁴⁾		
	SO-8 DIP8	40 41	°C/W
	Output short-circuit duration ⁽⁵⁾	Infinite	
T_{stg}	Storage temperature range	-65 to +150	°C
ESD	HBM: human body model ⁽⁶⁾	500	V
	MM: machine model ⁽⁷⁾	200	V
	CDM: charged device model ⁽⁸⁾	1.5	kV

- All voltage values, except differential voltage, are with respect to the zero reference level (ground) of the supply voltages where the zero reference level is the midpoint between V_{CC}^+ and V_{CC}^- .
- The magnitude of the input voltage must never exceed the magnitude of the supply voltage or 15 volts, whichever is less.
- Differential voltages are the non-inverting input terminal with respect to the inverting input terminal.
- Short-circuits can cause excessive heating and destructive dissipation. Values are typical.
- The output may be shorted to ground or to either supply. Temperature and/or supply voltages must be limited to ensure that the dissipation rating is not exceeded.
- Human body model: A 100 pF capacitor is charged to the specified voltage, then discharged through a 1.5 kΩ resistor between two pins of the device. This is done for all couples of connected pin combinations while the other pins are floating.
- Machine model: A 200 pF capacitor is charged to the specified voltage, then discharged directly between two pins of the device with no external series resistor (internal resistor < 5 Ω). This is done for all couples of connected pin combinations while the other pins are floating.
- Charged device model: all pins and the package are charged together to the specified voltage and then discharged directly to the ground through only one pin. This is done for all pins.

Table 2. Operating conditions

Symbol	Parameter	LF151	LF251	LF351	Unit
V_{CC}	Supply voltage	6 to 32			V
T_{oper}	Operating free-air temperature range	-55 to +125	-40 to +105	0 to +70	°C

3 Electrical characteristics

Table 3. Electrical characteristics at $V_{CC} = \pm 15\text{ V}$, $T_{amb} = +25^\circ\text{C}$ (unless otherwise specified)

Symbol	Parameter	Min.	Typ.	Max.	Unit
V_{io}	Input offset voltage ($R_S = 10\text{k}\Omega$) $T_{min} \leq T_{amb} \leq T_{max}$		3	10 13	mV
DV_{io}	Input offset voltage drift		10		$\mu\text{V}/^\circ\text{C}$
I_{io}	Input offset current ⁽¹⁾ $T_{min} \leq T_{amb} \leq T_{max}$		5	100 4	pA nA
I_{ib}	Input bias current ⁽¹⁾ $T_{min} \leq T_{amb} \leq T_{max}$		20	200 20	pA nA
A_{vd}	Large signal voltage gain ($R_L = 2\text{k}\Omega$, $V_o = \pm 10\text{V}$) $T_{min} \leq T_{amb} \leq T_{max}$	50 25	200		V/mV
SVR	Supply voltage rejection ratio ($R_S = 10\text{k}\Omega$) $T_{min} \leq T_{amb} \leq T_{max}$	80 80	86		dB
I_{CC}	Supply current, no load $T_{min} \leq T_{amb} \leq T_{max}$		1.4	3.4 3.4	mA
V_{icm}	Input common mode voltage range	± 11	+15 -12		V
CMR	Common mode rejection ratio ($R_S = 10\text{k}\Omega$) $T_{min} \leq T_{amb} \leq T_{max}$	70 70	86		dB
I_{OS}	Output short-circuit current $T_{min} \leq T_{amb} \leq T_{max}$	10 10	40	60 60	mA
$\pm V_{opp}$	Output voltage swing $R_L = 2\text{k}\Omega$ $R_L = 10\text{k}\Omega$ $T_{min} \leq T_{amb} \leq T_{max}$ $R_L = 2\text{k}\Omega$ $R_L = 10\text{k}\Omega$	10 12 10 12	12 13.5		V
SR	Slew rate, $V_i = 10\text{V}$, $R_L = 2\text{k}\Omega$, $C_L = 100\text{pF}$, unity gain	12	16		V/ μs
t_r	Rise time, $V_i = 20\text{mV}$, $R_L = 2\text{k}\Omega$, $C_L = 100\text{pF}$, unity gain		0.1		μs
K_{ov}	Overshoot, $V_i = 20\text{mV}$, $R_L = 2\text{k}\Omega$, $C_L = 100\text{pF}$, unity gain		10		%
GBP	Gain bandwidth product, $f = 100\text{kHz}$, $V_{in} = 10\text{mV}$, $R_L = 2\text{k}\Omega$, $C_L = 100\text{pF}$	2.5	4		MHz
R_i	Input resistance		10^{12}		Ω
THD	Total harmonic distortion $f = 1\text{kHz}$, $A_v = 20\text{dB}$, $R_L = 2\text{k}\Omega$, $C_L = 100\text{pF}$, $V_o = 2V_{pp}$		0.01		%
e_n	Equivalent input noise voltage $R_S = 100\Omega$, $f = 1\text{KHz}$		15		$\frac{\text{nV}}{\sqrt{\text{Hz}}}$
ϕ_m	Phase margin		45		Degrees

1. The input bias currents are junction leakage currents which approximately double for every 10°C increase in the junction temperature.

Figure 3. Maximum peak-to-peak output voltage versus frequency

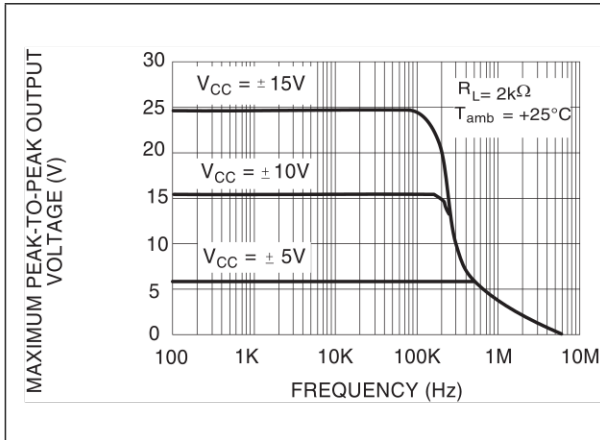

Figure 4. Maximum peak-to-peak output voltage versus frequency

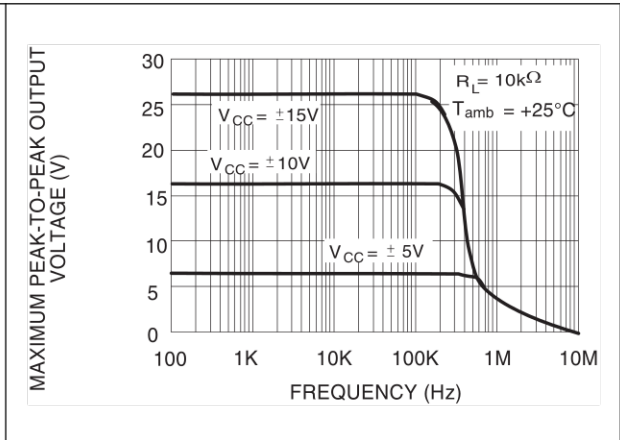

Figure 5. Maximum peak-to-peak output voltage versus frequency

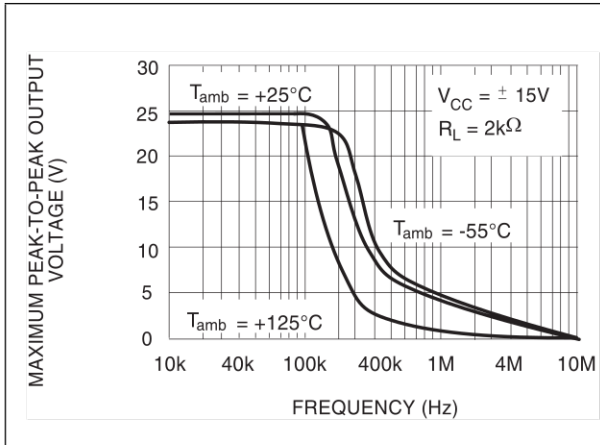

Figure 6. Maximum peak-to-peak output voltage versus free air temp.

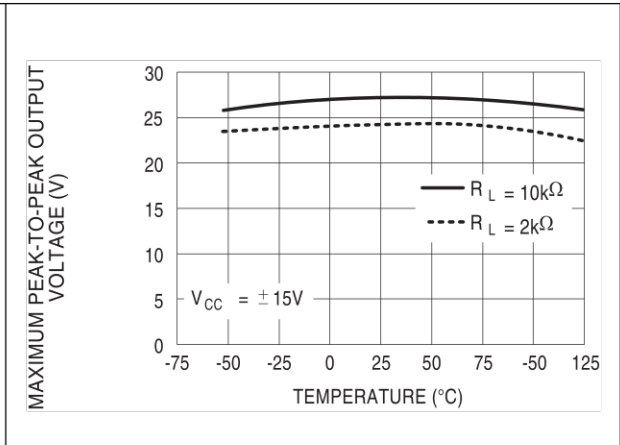

Figure 7. Maximum peak-to-peak output voltage versus load resistance

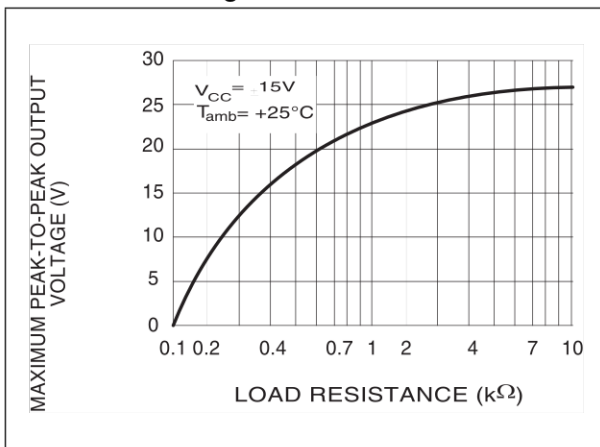

Figure 8. Maximum peak-to-peak output voltage versus supply voltage

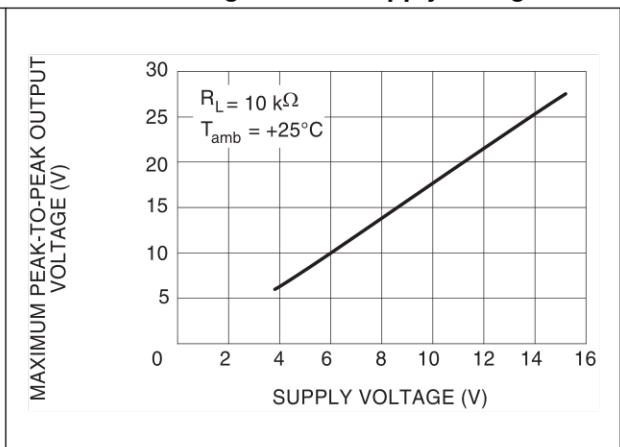

Figure 9. Input bias current versus free air temperature

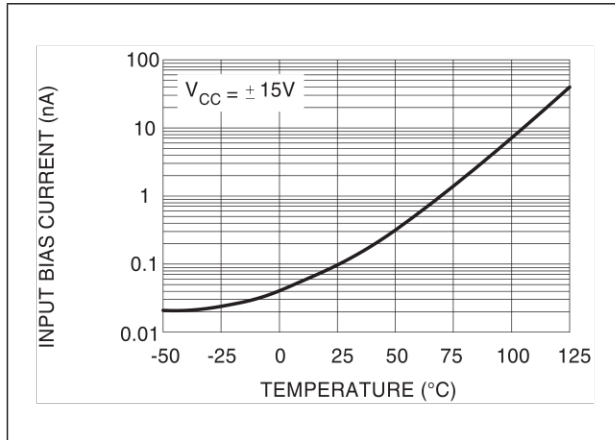

Figure 10. Large signal differential voltage amplification versus free air temp.

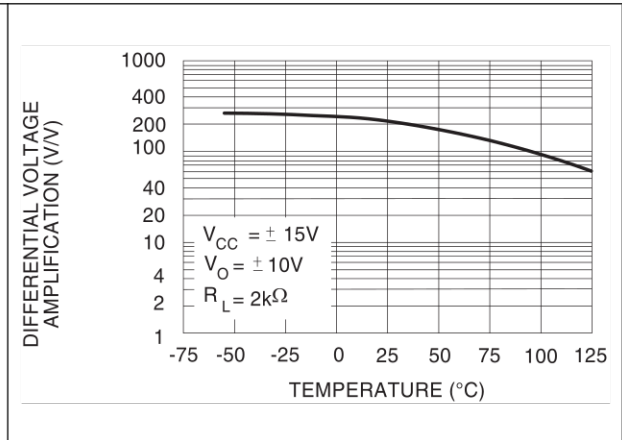

Figure 11. Large signal differential voltage amplification and phase shift versus frequency

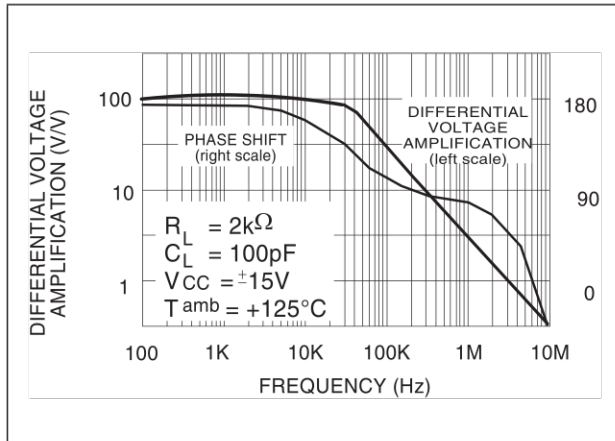

Figure 12. Total power dissipation versus free air temperature

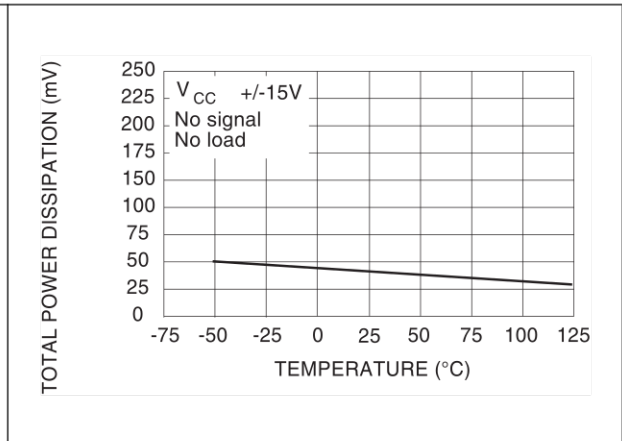

Figure 13. Supply current per amplifier versus free air temperature

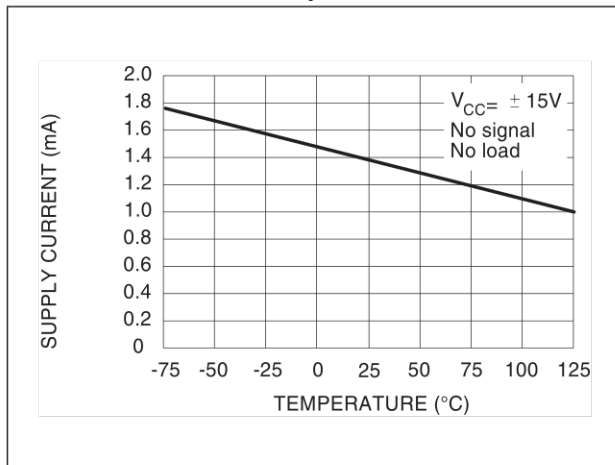

Figure 14. Supply current per amplifier versus supply voltage

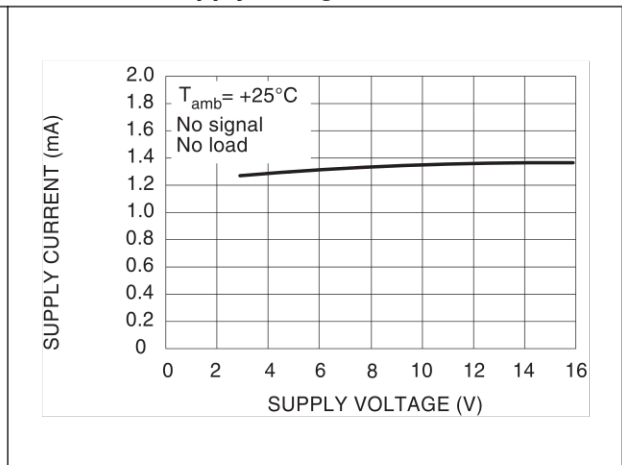

Figure 15. Common mode rejection ratio versus free air temperature

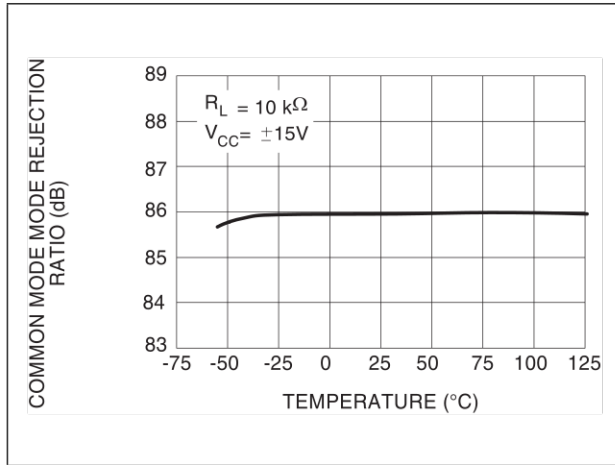

Figure 16. Voltage follower large signal pulse response

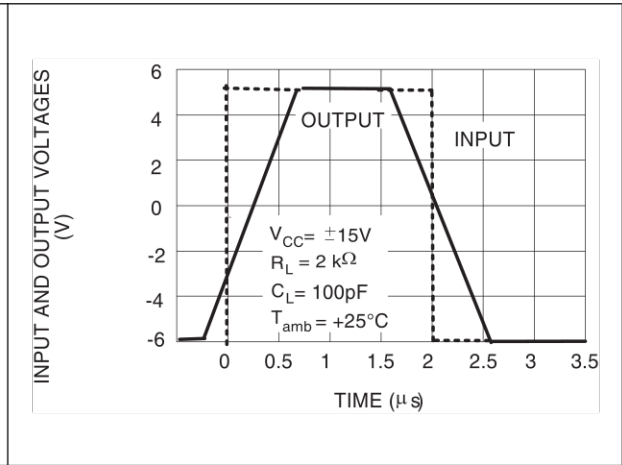

Figure 17. Output voltage versus elapsed time Figure 18. Equivalent input noise voltage versus frequency

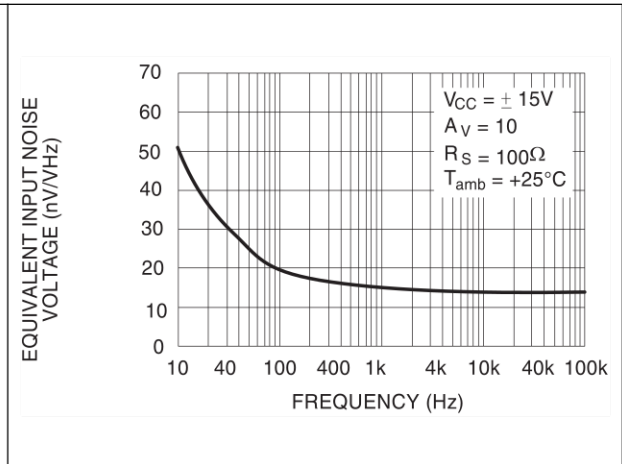
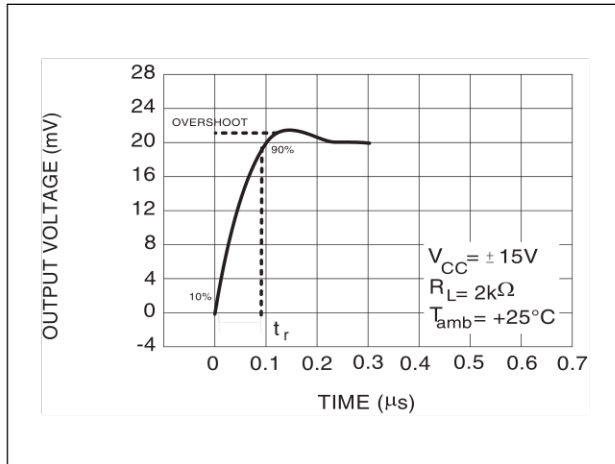
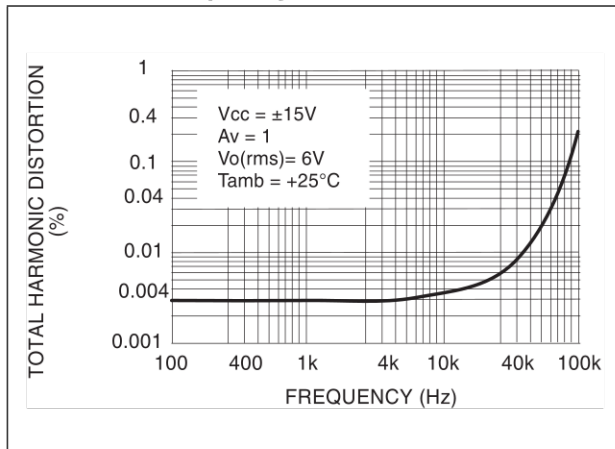

Figure 19. Total harmonic distortion versus frequency



4 Parameter measurement information

Figure 20. Voltage follower

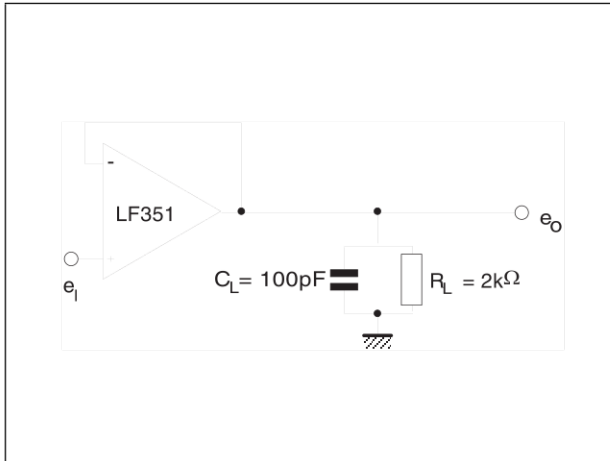
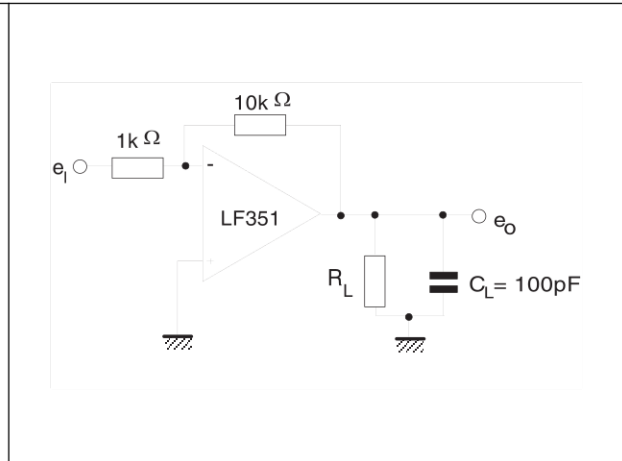

Figure 21. Gain-of-10 inverting amplifier



5 Typical application

Figure 22. Square wave oscillator (0.5 Hz)

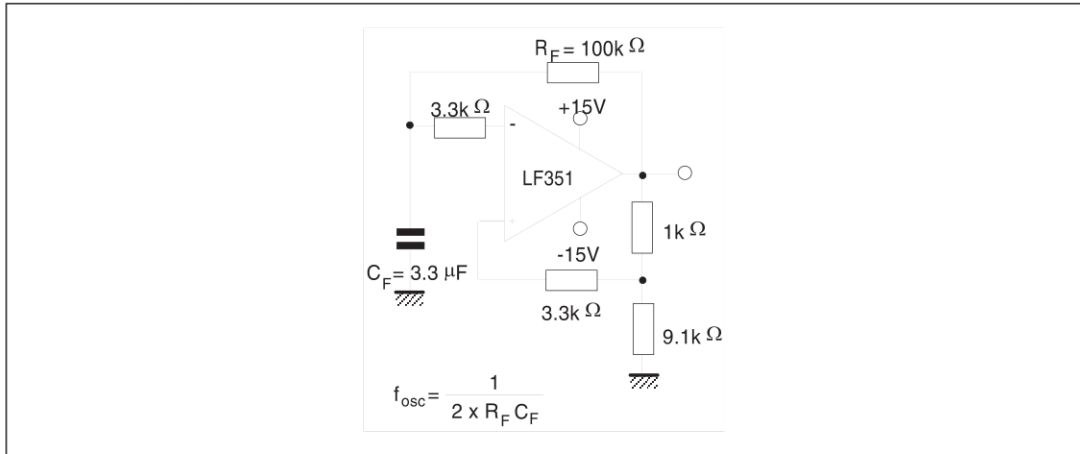
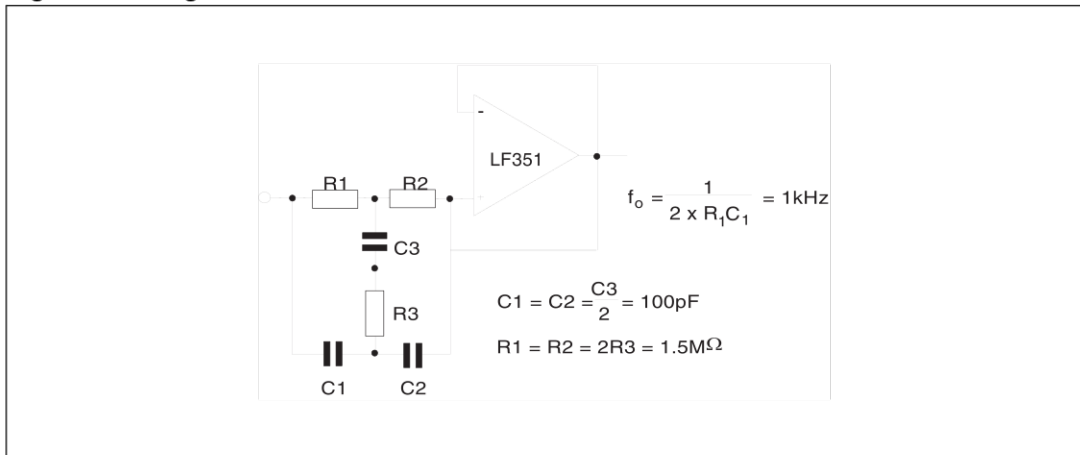

Figure 23. High Q notch filter



6 Package information

In order to meet environmental requirements, STMicroelectronics offers these devices in ECOPACK[®] packages. These packages have a lead-free second level interconnect. The category of second level interconnect is marked on the package and on the inner box label, in compliance with JEDEC Standard JESD97. The maximum ratings related to soldering conditions are also marked on the inner box label. ECOPACK is an STMicroelectronics trademark. ECOPACK specifications are available at: www.st.com.

6.1 DIP8 package information

Figure 24. DIP8 package mechanical drawing

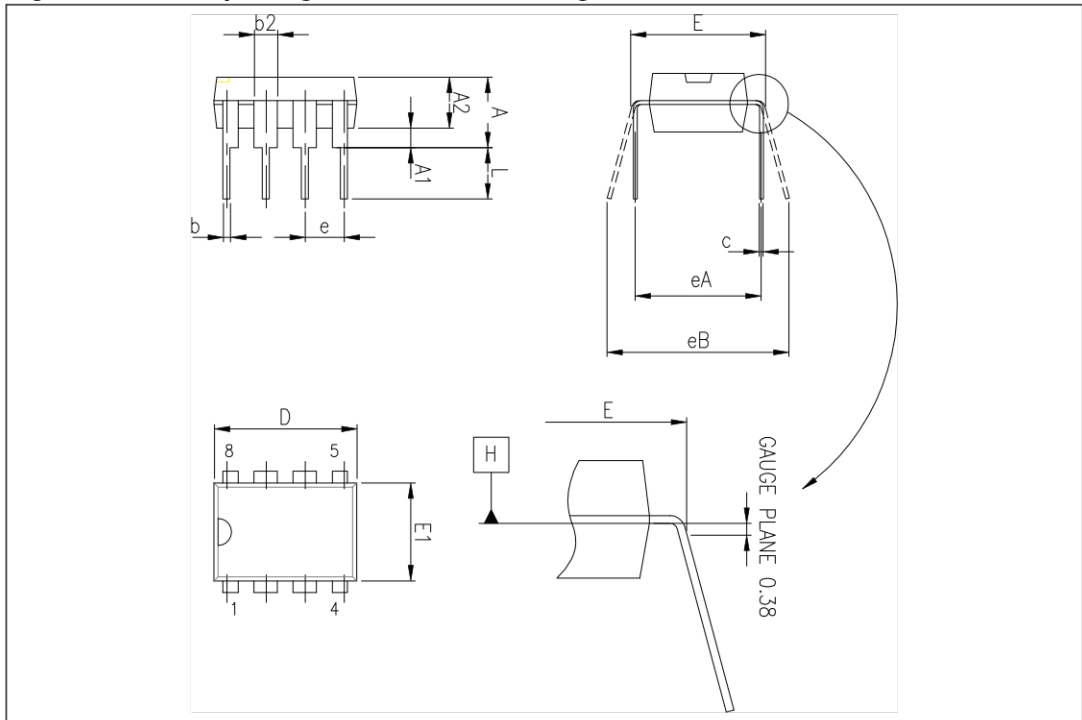

Table 4. DIP8 package mechanical data

Ref.	Dimensions					
	Millimeters			Inches		
	Min.	Typ.	Max.	Min.	Typ.	Max.
A			5.33			0.210
A1	0.38			0.015		
A2	2.92	3.30	4.95	0.115	0.130	0.195
b	0.36	0.46	0.56	0.014	0.018	0.022
b2	1.14	1.52	1.78	0.045	0.060	0.070
c	0.20	0.25	0.36	0.008	0.010	0.014
D	9.02	9.27	10.16	0.355	0.365	0.400
E	7.62	7.87	8.26	0.300	0.310	0.325
E1	6.10	6.35	7.11	0.240	0.250	0.280
e		2.54			0.100	
eA		7.62			0.300	
eB			10.92			0.430
L	2.92	3.30	3.81	0.115	0.130	0.150

6.2 SO-8 package information

Figure 25. SO-8 package mechanical drawing

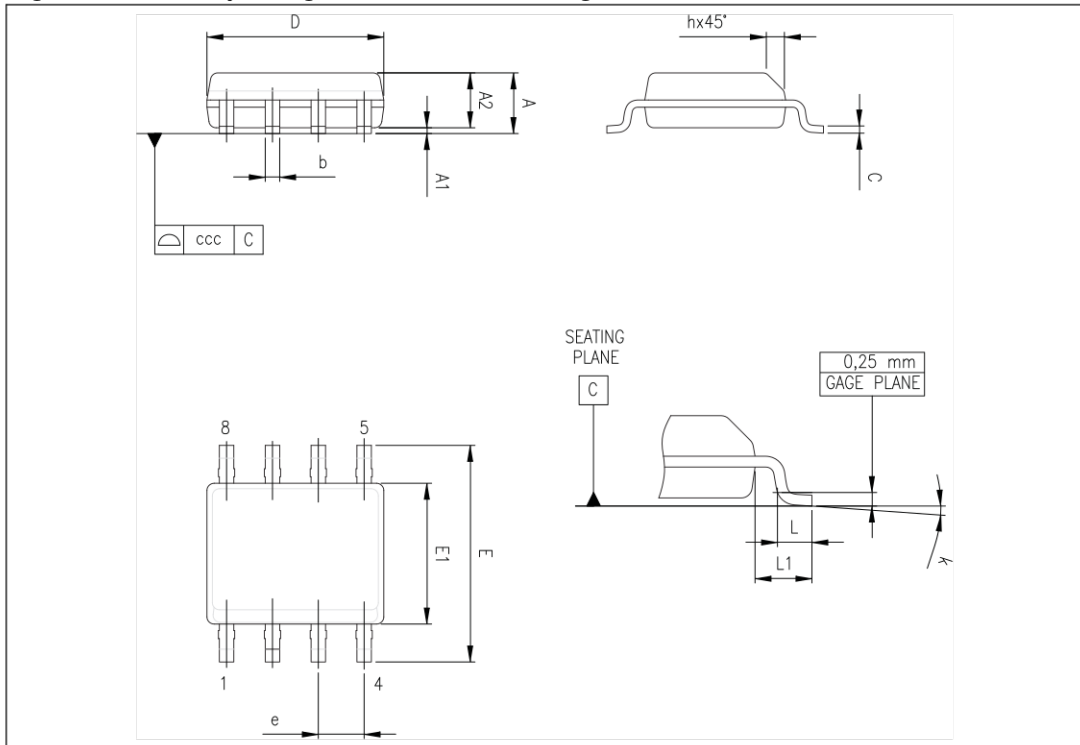

Table 5. SO-8 package mechanical data

Ref.	Dimensions					
	Millimeters			Inches		
	Min.	Typ.	Max.	Min.	Typ.	Max.
A			1.75			0.069
A1	0.10		0.25	0.004		0.010
A2	1.25			0.049		
b	0.28		0.48	0.011		0.019
c	0.17		0.23	0.007		0.010
D	4.80	4.90	5.00	0.189	0.193	0.197
E	5.80	6.00	6.20	0.228	0.236	0.244
E1	3.80	3.90	4.00	0.150	0.154	0.157
e		1.27			0.050	
h	0.25		0.50	0.010		0.020
L	0.40		1.27	0.016		0.050
k	1°		8°	1°		8°
ccc			0.10			0.004

7 Ordering information

Table 6. Order codes

Order code	Temperature range	Package	Packing	Marking
LF151N	-55°C, +125°C	DIP8	Tape	LF151N
LF151D LF151DT		SO-8	Tape or Tape & reel	151
LF251N	-40°C, +105°C	DIP8	Tape	LF251N
LF251D LF251DT		SO-8	Tape or Tape & reel	251
LF351N	0°C, +70°C	DIP8	Tape	LF351N
LF351D LF351DT		SO-8	Tape or Tape & reel	351

8 Revision history

Table 7. Document revision history

Date	Revision	Changes
17-May-2001	1	Initial release.
28-April-2008	2	Updated document format.

Please Read Carefully:

Information in this document is provided solely in connection with ST products. STMicroelectronics NV and its subsidiaries ("ST") reserve the right to make changes, corrections, modifications or improvements, to this document, and the products and services described herein at any time, without notice.

All ST products are sold pursuant to ST's terms and conditions of sale.

Purchasers are solely responsible for the choice, selection and use of the ST products and services described herein, and ST assumes no liability whatsoever relating to the choice, selection or use of the ST products and services described herein.

No license, express or implied, by estoppel or otherwise, to any intellectual property rights is granted under this document. If any part of this document refers to any third party products or services it shall not be deemed a license grant by ST for the use of such third party products or services, or any intellectual property contained therein or considered as a warranty covering the use in any manner whatsoever of such third party products or services or any intellectual property contained therein.

UNLESS OTHERWISE SET FORTH IN ST'S TERMS AND CONDITIONS OF SALE ST DISCLAIMS ANY EXPRESS OR IMPLIED WARRANTY WITH RESPECT TO THE USE AND/OR SALE OF ST PRODUCTS INCLUDING WITHOUT LIMITATION IMPLIED WARRANTIES OF MERCHANTABILITY, FITNESS FOR A PARTICULAR PURPOSE (AND THEIR EQUIVALENTS UNDER THE LAWS OF ANY JURISDICTION), OR INFRINGEMENT OF ANY PATENT, COPYRIGHT OR OTHER INTELLECTUAL PROPERTY RIGHT.

UNLESS EXPRESSLY APPROVED IN WRITING BY AN AUTHORIZED ST REPRESENTATIVE, ST PRODUCTS ARE NOT RECOMMENDED, AUTHORIZED OR WARRANTED FOR USE IN MILITARY, AIR CRAFT, SPACE, LIFE SAVING, OR LIFE SUSTAINING APPLICATIONS, NOR IN PRODUCTS OR SYSTEMS WHERE FAILURE OR MALFUNCTION MAY RESULT IN PERSONAL INJURY, DEATH, OR SEVERE PROPERTY OR ENVIRONMENTAL DAMAGE. ST PRODUCTS WHICH ARE NOT SPECIFIED AS "AUTOMOTIVE GRADE" MAY ONLY BE USED IN AUTOMOTIVE APPLICATIONS AT USER'S OWN RISK.

Resale of ST products with provisions different from the statements and/or technical features set forth in this document shall immediately void any warranty granted by ST for the ST product or service described herein and shall not create or extend in any manner whatsoever, any liability of ST.

ST and the ST logo are trademarks or registered trademarks of ST in various countries.

Information in this document supersedes and replaces all information previously supplied.

The ST logo is a registered trademark of STMicroelectronics. All other names are the property of their respective owners.

© 2008 STMicroelectronics - All rights reserved

STMicroelectronics group of companies

Australia - Belgium - Brazil - Canada - China - Czech Republic - Finland - France - Germany - Hong Kong - India - Israel - Italy - Japan - Malaysia - Malta - Morocco - Singapore - Spain - Sweden - Switzerland - United Kingdom - United States of America

www.st.com