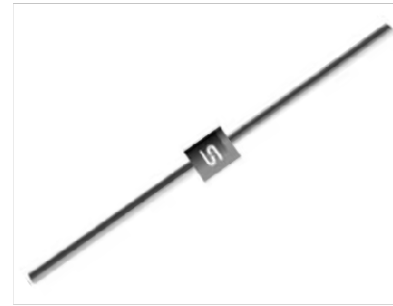

CREAT BY ART

Schottky Barrier Rectifier

FEATURES

- Low forward voltage drop
- Low power loss, high efficiency
- Guardring for overvoltage protection
- High surge current capability
- Compliant to RoHS Directive 2011/65/EU and in accordance to WEEE 2002/96/EC
- Halogen-free according to IEC 61249-2-21 definition

DO-201AD

MECHANICAL DATA

Case: DO-201AD

Molding compound, UL flammability classification rating 94V-0

Base P/N with suffix "G" on packing code - halogen-free

Base P/N with prefix "H" on packing code - AEC-Q101 qualified

Terminal: Matte tin plated leads, solderable per JESD22-B102

Meet JESD 201 class 1A whisker test,

with prefix "H" on packing code meet JESD 201 class 2 whisker test

Weight: 1.1 g (approximately)

MAXIMUM RATINGS AND ELECTRICAL CHARACTERISTICS (T_A=25°C unless otherwise noted)

PARAMETER	SYMBOL	SR 502	SR 503	SR 504	SR 505	SR 506	SR 509	SR 510	SR 515	SR 520	UNIT	
Maximum repetitive peak reverse voltage	V _{RRM}	20	30	40	50	60	90	100	150	200	V	
Maximum RMS voltage	V _{RMS}	14	21	28	35	42	63	70	105	140	V	
Maximum DC blocking voltage	V _{DC}	20	30	40	50	60	90	100	150	200	V	
Maximum average forward rectified current	I _{F(AV)}	5									A	
Peak forward surge current, 8.3 ms single half sine-wave superimposed on rated load	I _{FSM}	120									A	
Maximum instantaneous forward voltage (Note 1) @ 5 A	V _F	0.55			0.70		0.85		1.05		V	
Maximum reverse current @ rated VR T _J =25 °C T _J =100 °C T _J =125 °C	I _R	0.5					0.1					mA
		15			10		-					
		-			-		5		1			
Voltage rate of change (Rated V _R)	dV/dt	10000									V/μs	
Typical thermal resistance	R _{θJC}	6									°C/W	
	R _{θJA}	35										
Operating junction temperature range	T _J	- 55 to +125				- 55 to +150						°C
Storage temperature range	T _{STG}	- 55 to +150									°C	

Note 1: Pulse test with PW=300 μs, 1% duty cycle

CREATED BY ART

ORDERING INFORMATION

PART NO.	AEC-Q101 QUALIFIED	PACKING CODE	GREEN COMPOUND CODE	PACKAGE	PACKING
SR5xx (Note 1)	Prefix "H"	A0	Suffix "G"	DO-201AD	500 / Ammo box
		R0		DO-201AD	1,250 / 13" Paper reel
		B0		DO-201AD	500 / Bulk packing
		X0		DO-201AD	Forming

Note 1: "xx" defines voltage from 20V (SR502) to 200V (SR520)

EXAMPLE

PREFERRED P/N	PART NO.	AEC-Q101 QUALIFIED	PACKING CODE	GREEN COMPOUND CODE	DESCRIPTION
SR506 A0	SR506		A0		
SR506 A0G	SR506		A0	G	Green compound
SR506HA0	SR506	H	A0		AEC-Q101 qualified

RATINGS AND CHARACTERISTICS CURVES

(TA=25°C unless otherwise noted)

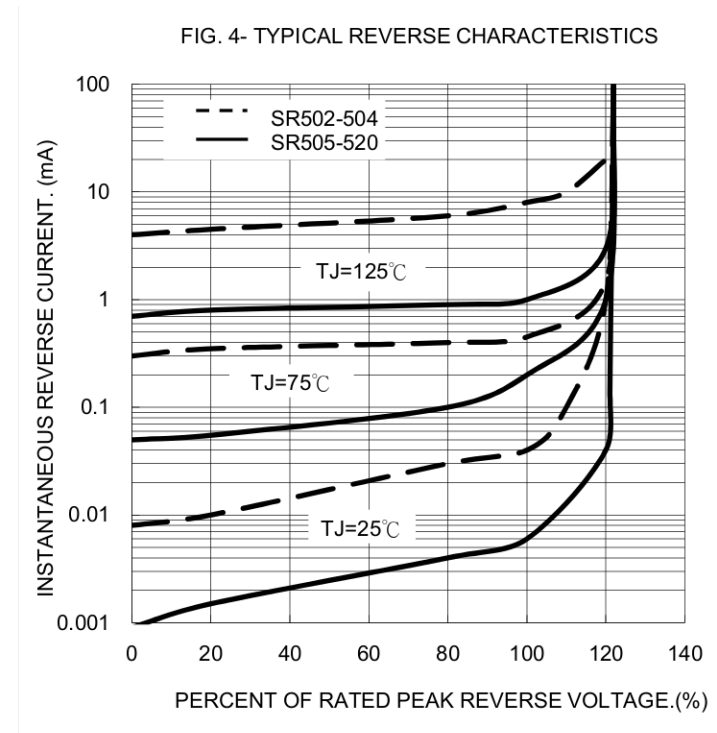
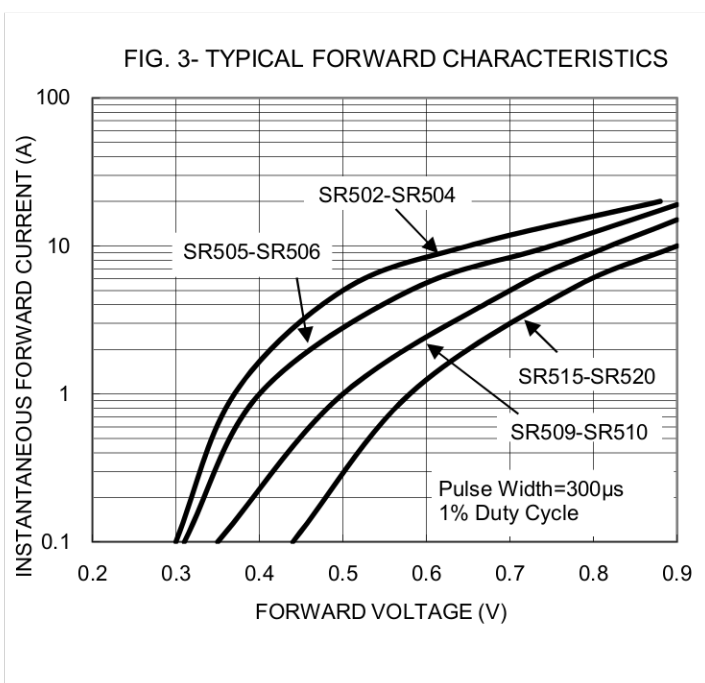
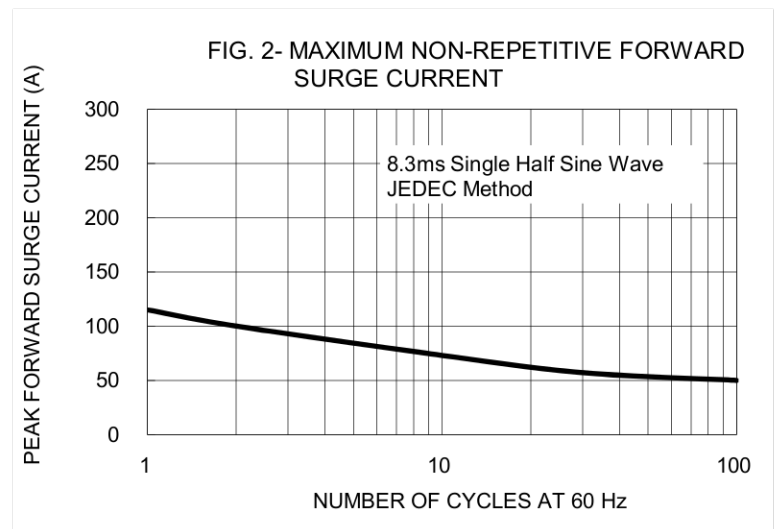
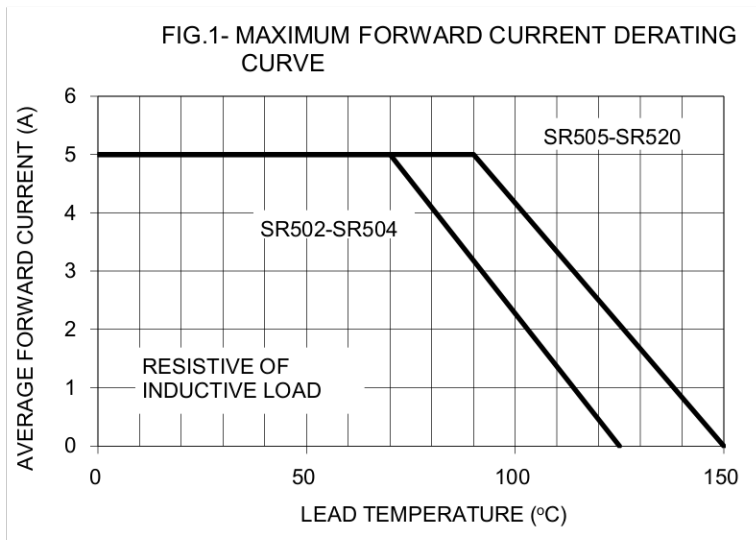

CREAT BY ART

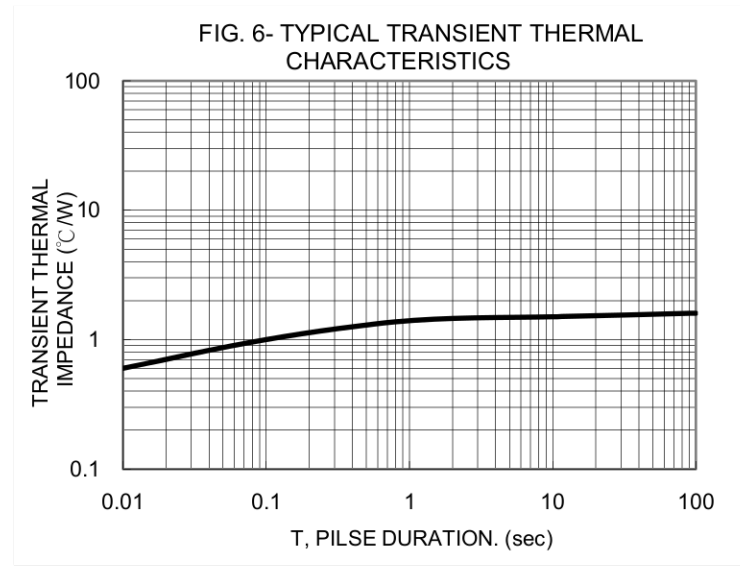
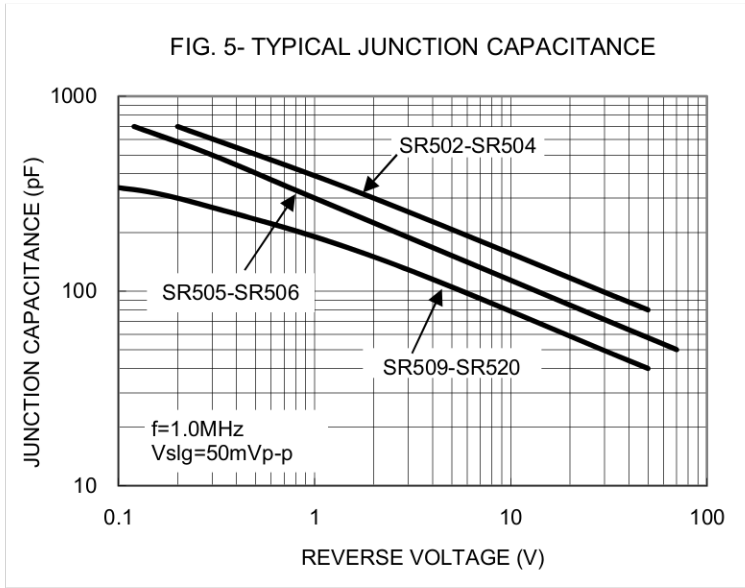

PACKAGE OUTLINE DIMENSIONS

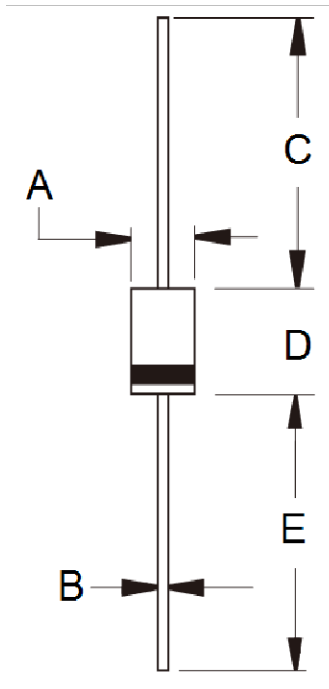

DIM.	Unit (mm)		Unit (inch)	
	Min	Max	Min	Max
A	5.00	5.60	0.197	0.220
B	1.20	1.30	0.048	0.052
C	25.40	-	1.000	-
D	8.50	9.50	0.335	0.375
E	25.40	-	1.000	-

MARKING DIAGRAM



P/N = Specific Device Code
 G = Green Compound
 YWW = Date Code
 F = Factory Code

Notice

Specifications of the products displayed herein are subject to change without notice. TSC or anyone on its behalf, assumes no responsibility or liability for any errors inaccuracies.

Information contained herein is intended to provide a product description only. No license, express or implied, to any intellectual property rights is granted by this document. Except as provided in TSC's terms and conditions of sale for such products, TSC assumes no liability whatsoever, and disclaims any express or implied warranty, relating to sale and/or use of TSC products including liability or warranties relating to fitness for a particular purpose, merchantability, or infringement of any patent, copyright, or other intellectual property right.

The products shown herein are not designed for use in medical, life-saving, or life-sustaining applications. Customers using or selling these products for use in such applications do so at their own risk and agree to fully indemnify TSC for any damages resulting from such improper use or sale.