

**Power Relay K (Open – Sealed)**

- Limiting continuous current 45A
- Wide voltage range
- 24VDC coil versions available
- For high current version refer to Power Relay K-S

Typical applications

ABS control, blower fans, car alarm, cooling fan, engine control, fuel pump, hazard warning signal, heated front screen, heated rear screen, ignition, lamps front/rear/fog light, interior lights, main switch/supply relay, seat control, seatbelt pretensioner, sun roof, turn signal, valves, window lifter, wiper control.

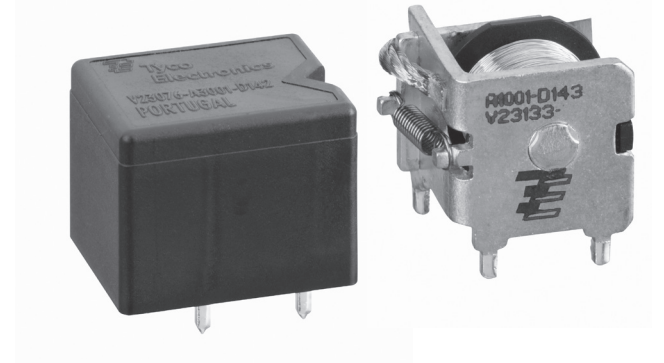

**Contact Data**

Typical applications	Resistive/inductive loads	Resistive/inductive loads	Indicator lamps	Headlights, capacitive loads	Headlights capacitive loads
Contact arrangement	1 form A, 1 NO	1 form C, 1 CO	1 form A, 1 NO	1 form A, 1 NO	1 form C, 1 CO
Rated voltage	12VDC	12VDC	12VDC	12VDC	12VDC
Rated current	45A	A/B (NO/NC)	30A	40A	A/B (NO/NC)
Limiting continuous current		45/30A			40/25A
23°C	45A	45/30A	30A	40A	40/25A
85°C	30A	30/25A	25A	25A	25/20A
Limiting making current <sup>1)</sup>	100A	100/30A	120A <sup>3)</sup>	180A	180/60A
Limiting breaking current <sup>2)</sup>	60A	60/30A	60A	60A	60/30A
Contact material	AgNi0.15	AgNi0.15	AgSnO <sub>2</sub>	AgSnO <sub>2</sub>	AgSnO <sub>2</sub>
Min. recommended contact load		1A at 5VDC <sup>4)</sup>			
Initial voltage drop, at 10A, typ./max.		20/300mV			
Operate/release time		typ. 5/3ms <sup>5)</sup>			
Electrical endurance	>2x10 <sup>5</sup> ops. at 13.5VDC, 40A	>2x10 <sup>5</sup> ops. at 13.5VDC, 40A	>2.2x10 <sup>6</sup> ops. up to 8x21W	>10 <sup>5</sup> ops. up to 4x60W	>10 <sup>5</sup> ops. up to 4x60W
Mechanical endurance, DC coil		>10 <sup>7</sup> ops.			

- 1) The values apply to a resistive or inductive load with suitable spark suppression and at maximum 13.5VDC for 12VDC or 27VDC for 24VDC load voltages.
- 2) For a load current duration of maximum 3s for a make/break ratio of 1:10.
- 3) Corresponds to a peak inrush current on initial actuation (cold filament).
- 4) See chapter Diagnostics of Relays in our Application Notes or consult the internet at <http://relays.te.com/appnotes/>
- 5) For unsuppressed relay coil. A low resistive suppression device in parallel to the relay coil increases the release time and reduces the lifetime caused by increased erosion and/or higher risk of contact tack welding.

**Max. DC load breaking capacity**

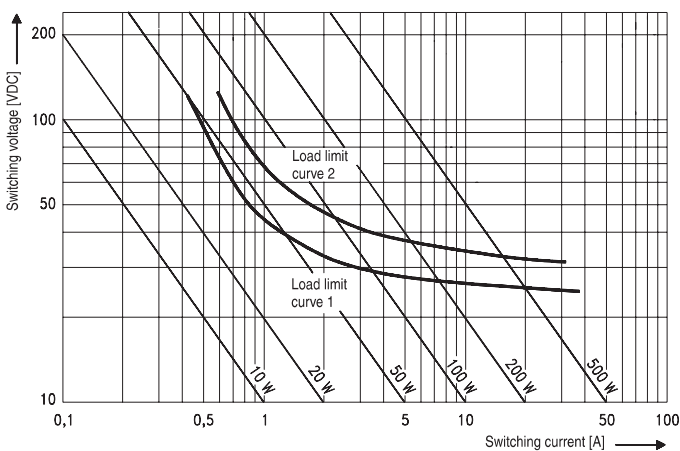

Load limit curve 1: arc extinguishes, during transit time (changeover contact).  
 Load limit curve 2: safe shutdown, no stationary arc (make contact).  
 Load limit curves measured with low inductive resistors verified for 1000 switching events.

**Power Relay K (Open – Sealed)** (Continued)

**Coil Data**

Rated coil voltage	12VDC / 24VDC
--------------------	---------------

**Coil versions, DC coil**

Coil code	Rated voltage VDC	Operate voltage VDC	Release voltage VDC	Coil resistance $\Omega \pm 10\%$	Rated coil power W
001	12	6.9	1.2	90	1.6
022	24	14.1	2.4	362	1.6

All figures are given for coil without pre-energization, at ambient temperature +23°C. Other coils on request.

**Coil operating range**

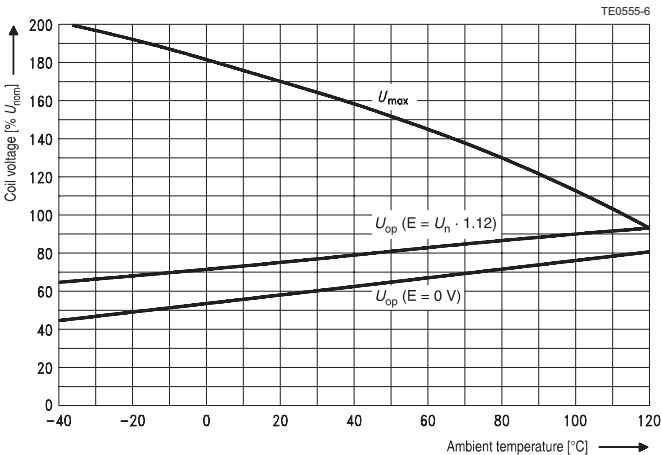

Does not take into account the temperature rise due to the contact current  
E = pre-energization

**Insulation Data**

Initial dielectric strength	
between open contacts	500VAC <sub>rms</sub>
between contact and coil	500VAC <sub>rms</sub>

**Other Data**

EU RoHS/ELV compliance	compliant
Ambient temperature, DC coil	-40 to +85°C <sup>6)</sup>
Climatic cycling with condensation, EN ISO 6988	3 cycles, storage 8/16h
Temperature cycling (shock), IEC 60068-2-14, Na	20 cycles, -40/+85°C (dwell time 1h)
Damp heat cyclic, IEC 60068-2-30, Db, Variant 1	6 cycles, upper air temperature 55°C
Damp heat constant, IEC 60068-2-3, method Ca	56 days, upper air temperature 55°C
Degree of protection, IEC 61810	RT 0/II – open version RT III – immersion cleanable version
Corrosive gas, IEC 60068-2-42	10 days
IEC 60068-2-43	10 days
Vibration resistance (functional), IEC 60068-2-6 (sine pulse form), acceleration, acc. to position	10 to 200Hz, 20 to 40g <sup>7)</sup>
Shock resistance (functional), IEC 60068-2-27 (half sine form single pulses), acceleration, acc. to position	8ms 30g <sup>7)</sup>
Terminal type	PCB
Weight	
sealed version	approx. 22g (0.77oz)
open version	approx. 19g (0.67oz)
Solderability (aging 3: 4h/155°C) for leaded process ( $T_m = 183^\circ\text{C}$ ), for Pb-free process ( $T_m = 217^\circ\text{C}$ ), IEC 60068-2-20	Ta, method 1, hot dip 5s, 215°C according IEC 600688 <sup>8)</sup>
Storage conditions	
Packaging unit	
sealed version	525 pcs.
open version	500 pcs.

6) See coil operating range DC.

7) No change in the switching state >10 $\mu$ s.

8) For general storage and processing recommendations please refer to our Application Notes and especially to Storage in the Definitions or at <http://relays.te.com/appnotes/>

**Terminal Assignment (Open and Sealed Version)**

Bottom view on solder pins

1 form A, 1 NO

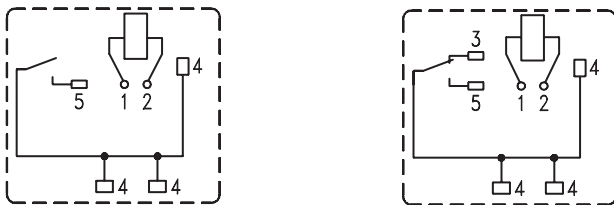

\*) Terminal 4 to be bridged

**Power Relay K (Open – Sealed)** (Continued)

**Dimensions**

Power Relay K open version

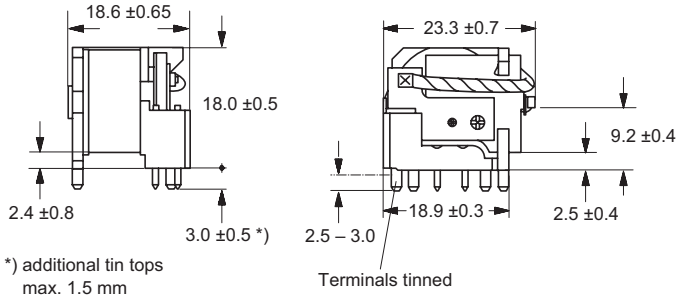

\*) additional tin tops  
max. 1.5 mm

Power Relay K sealed version

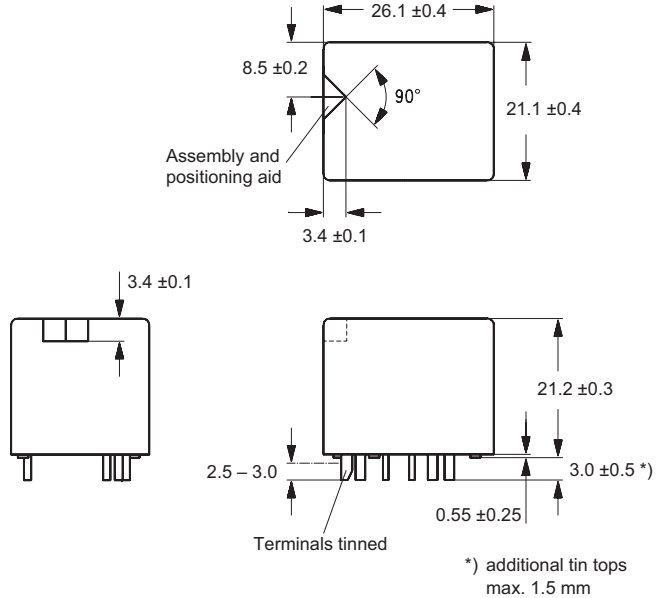

\*) additional tin tops  
max. 1.5 mm

**Mounting Hole Layout**

Bottom view on solder pins

Power Relay K open version

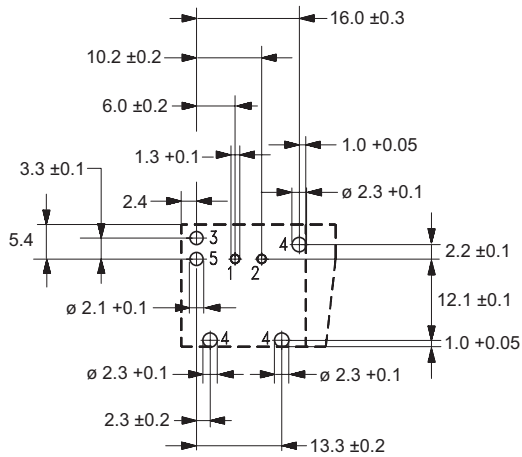

Power Relay K sealed version

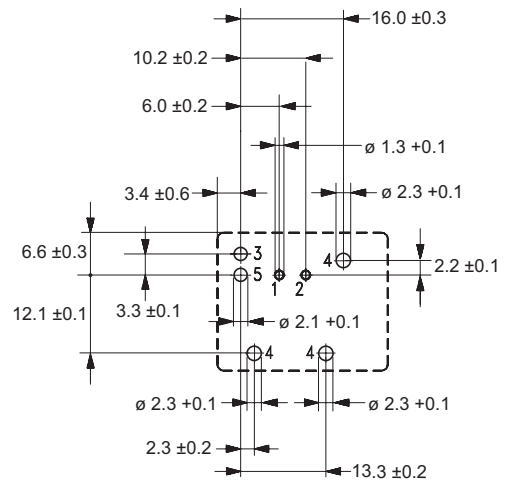

**Power Relay K (Open – Sealed)** (Continued)

<b>Product code structure</b>		Typical product code		<b>V23076</b>	<b>-A</b>	<b>1</b>	<b>022</b>	<b>-C</b>	<b>13</b>	<b>3</b>
<b>Type</b>										
<b>V23076</b>		Power Relay K, sealed								
<b>V23133</b>		Power Relay K, open								
<b>Terminal</b>										
<b>A</b>		PCB								
<b>Design</b>										
<b>1</b>		Single relay		<b>3</b>	Single relay					
<b>Coil</b>										
<b>001</b>		12VDC		<b>022</b>	24VDC					
<b>Contact type</b>										
<b>C</b>		Single contact		<b>D</b>	Single contact					
<b>Contact material</b>										
<b>13</b>		AgNi0.15		<b>14</b>	AgSnO <sub>2</sub>					
<b>15</b>		AgSnO <sub>2</sub> (Special)								
<b>Contact arrangement</b>										
<b>2</b>		1 form A, 1 NO		<b>3</b>	1 form C, 1 CO					

Product code	Terminal/Encl.	Design	Coil	Contact	Cont. material	Arrangement	Part number				
V23076-A1001-C133	PCB, sealed	Single relay	12VDC	Single	AgNi0.15	1 form C, CO	1393277-4				
V23076-A1001-D143					AgSnO <sub>2</sub>		1393277-6				
V23076-A3001-C132	PCB, open	Single relay	12VDC	Single	AgNi0.15	1 form A, NO	1-1393277-4				
V23076-A3001-D142					AgSnO <sub>2</sub>		1-1393277-7				
V23076-A3001-D152 <sup>1)</sup>					AgSnO <sub>2</sub> special	1-1414175-0					
V23076-A1022-C133					24VDC	AgNi0.15	1393277-8				
V23076-A1022-D143						AgSnO <sub>2</sub>	1393277-9				
V23076-A3022-C132					24VDC	Single relay	12VDC	Single	AgNi0.15	1 form A, NO	1-1393277-8
V23076-A3022-D142									AgSnO <sub>2</sub>		1-1393277-9
V23133-A1001-C133									AgNi0.15	1393278-7	
V23133-A1001-D143									AgSnO <sub>2</sub>	1-1393278-3	
V23133-A3001-C132									AgNi0.15	5-1393278-7	
V23133-A3001-D142	AgSnO <sub>2</sub>	5-1393278-9									
V23133-A3001-D152 <sup>1)</sup>	AgSnO <sub>2</sub> special	1-1414173-0									
V23133-A1022-C133	AgNi0.15	3-1393278-7									
V23133-A1022-D143	AgSnO <sub>2</sub>	3-1393278-9									
V23133-A3022-C132	1 form A, NO	AgNi0.15	7-1393278-1								
V23133-A3022-D142		AgSnO <sub>2</sub>	7-1393278-2								
V23133-A3022-D152 <sup>1)</sup>		AgSnO <sub>2</sub> special	1-1414174-0								

1) For indicator lamps.