



## Professional Thin Film MELF Resistors



MMU 0102, MMA 0204, and MMB 0207 professional thin film MELF resistors are the perfect choice for most fields of modern professional electronics where reliability and stability is of major concern. The typical applications in the fields of automotive, telecommunication and medical equipment reflect the outstanding level of proven reliability.

### FEATURES

- Approved according to EN 140401-803
- AEC-Q200 qualified
- Advanced metal film technology
- Excellent overall stability: exceeds class 0.25
- Best in class pulse load capability
- Intrinsic sulfur resistance
- Material categorization: for definitions of compliance please see [www.vishay.com/doc?99912](http://www.vishay.com/doc?99912)



### APPLICATIONS

- Automotive
- Telecommunication
- Industrial
- Medical equipment

TECHNICAL SPECIFICATIONS			
DESCRIPTION	MMU 0102	MMA 0204	MMB 0207
DIN size	0102	0204	0207
Metric size code	RC2211M	RC3715M	RC6123M
Resistance range	0.22 Ω to 2.21 MΩ; 0 Ω	0.22 Ω to 10 MΩ; 0 Ω	0.1 Ω to 15 MΩ; 0 Ω
Resistance tolerance	± 5 %; ± 2 %; ± 1 %; ± 0.5 %	± 5 %; ± 1 %; ± 0.5 %	± 5 %; ± 2 %; ± 1 %; ± 0.5 %
Temperature coefficient	± 50 ppm/K; ± 25 ppm/K		± 100 ppm/K; ± 50 ppm/K; ± 25 ppm/K
Rated dissipation, $P_{70}^{(1)}$	0.3 W	0.4 W	1.0 W
Operating voltage, $U_{max}$ AC <sub>RMS</sub> /DC	150 V	200 V	350 V
Permissible film temperature, $\vartheta_{F max}^{(1)}$	155 °C		
Operating temperature range <sup>(1)</sup>	-55 °C to 155 °C		
Permissible voltage against ambient (insulation): 1 min, $U_{ins}$	200 V	300 V	500 V
Failure rate: FIT <sub>observed</sub>	≤ 0.1 x 10 <sup>-9</sup> /h		

#### Note

<sup>(1)</sup> Please refer to APPLICATION INFORMATION below

### APPLICATION INFORMATION

When the resistor dissipates power, a temperature rise above the ambient temperature occurs, dependent on the thermal resistance of the assembled resistor together with the printed circuit board. The rated dissipation applies only if the permitted film temperature is not exceeded.

These resistors do not feature a limited lifetime when operated within the permissible limits. However, resistance value drift increasing over operating time may result in exceeding a limit acceptable to the specific application, thereby establishing a functional lifetime.



MAXIMUM RESISTANCE CHANGE AT RATED DISSIPATION			
OPERATION MODE		STANDARD	POWER
Rated dissipation, $P_{70}$	MMU 0102	0.2 W	0.3 W
	MMA 0204	0.25 W	0.4 W
	MMB 0207	0.4 W	1.0 W
Operating temperature range		-55 °C to 125 °C	-55 °C to 155 °C
Permissible film temperature, $\vartheta_F$ max.		125 °C	155 °C
Max. resistance change at $P_{70}$ for resistance range, $ \Delta R/R $ after:	MMU 0102	0.22 $\Omega$ to 2.21 M $\Omega$	0.22 $\Omega$ to 2.21 M $\Omega$
	MMA 0204	0.22 $\Omega$ to 10 M $\Omega$	0.22 $\Omega$ to 10 M $\Omega$
	MMB 0207	0.1 $\Omega$ to 15 M $\Omega$	0.1 $\Omega$ to 15 M $\Omega$
	1000 h	$\leq 0.15$ %	$\leq 0.25$ %
	8000 h	$\leq 0.3$ %	$\leq 0.5$ %
	225 000 h	$\leq 1.0$ %	-

**Note**

- The presented operation modes do not refer to different types of resistors, but actually show examples of different loads, that lead to different film temperatures and different achievable load-life stability (drift) of the resistance value. A suitable low thermal resistance of the circuit board assembly must be safeguarded in order to maintain the film temperature of the resistors within the specified limits. Please consider the application note "Thermal Management in Surface-Mounted Resistor Applications" ([www.vishay.com/doc?28844](http://www.vishay.com/doc?28844)) for information on the general nature of thermal resistance

TEMPERATURE COEFFICIENT AND RESISTANCE RANGE				
TYPE/SIZE	TCR	TOLERANCE	RESISTANCE	E-SERIES
MMU 0102	$\pm 50$ ppm/K	$\pm 5$ %	0.22 $\Omega$ to 0.91 $\Omega$	E24
		$\pm 2$ %	1 $\Omega$ to 9.1 $\Omega$	
		$\pm 1$ %	10 $\Omega$ to 2.21 M $\Omega$	E24; E96
		$\pm 0.5$ %	10 $\Omega$ to 221 k $\Omega$	E24; E192
	$\pm 25$ ppm/K	$\pm 1$ %	10 $\Omega$ to 221 k $\Omega$	E24; E96
		$\pm 0.5$ %	10 $\Omega$ to 221 k $\Omega$	E24; E192
	Jumper; $I_{max.} = 2$ A	$\leq 10$ m $\Omega$	0 $\Omega$	-
MMA 0204	$\pm 50$ ppm/K	$\pm 5$ %	0.22 $\Omega$ to 0.91 $\Omega$	E24
		$\pm 1$ %	0.22 $\Omega$ to 0.91 $\Omega$ <sup>(1)</sup>	
		$\pm 1$ %	1 $\Omega$ to 10 M $\Omega$	E24; E96
		$\pm 0.5$ %	10 $\Omega$ to 2.21 M $\Omega$	E24; E192
	$\pm 25$ ppm/K	$\pm 1$ %	10 $\Omega$ to 511 k $\Omega$	E24; E96
		$\pm 0.5$ %	10 $\Omega$ to 511 k $\Omega$	E24; E192
	Jumper; $I_{max.} = 3$ A	$\leq 10$ m $\Omega$	0 $\Omega$	-
MMB 0207	$\pm 100$ ppm/K	$\pm 5$ %	0.1 $\Omega$ to 0.2 $\Omega$	E24
		$\pm 2$ %	0.1 $\Omega$ to 0.2 $\Omega$ <sup>(1)</sup>	
	$\pm 50$ ppm/K	$\pm 5$ %	0.22 $\Omega$ to 0.91 $\Omega$	
		$\pm 2$ %	0.22 $\Omega$ to 0.91 $\Omega$	
		$\pm 1$ %	0.22 $\Omega$ to 0.91 $\Omega$ <sup>(1)</sup>	
	$\pm 25$ ppm/K	$\pm 1$ %	1 $\Omega$ to 15 M $\Omega$	E24; E96
		$\pm 0.5$ %	10 $\Omega$ to 1 M $\Omega$	E24; E192
Jumper; $I_{max.} = 5$ A	$\leq 10$ m $\Omega$	0 $\Omega$	-	

**Note**

<sup>(1)</sup> Approval according to EN 140401-803 not available



PACKAGING						
TYPE/SIZE	CODE	QUANTITY	PACKAGING STYLE	WIDTH	PITCH	PACKAGING DIMENSIONS
MMU 0102	B3 = BL	3000	Antistatic blister tape acc. IEC 60286-3, Type 2a	8 mm	4 mm	Ø 180 mm/7"
	B0	10 000				Ø 330 mm/13"
	M8	8000	Bulk case acc. IEC 60286-6	-	-	-
MMA 0204	B3 = BL	3000	Antistatic blister tape acc. IEC 60286-3, Type 2a	8 mm	4 mm	Ø 180 mm/7"
	B0	10 000				Ø 330 mm/13"
	M3	3000	Bulk case acc. IEC 60286-6	-	-	-
MMB 0207	B2	2000	Antistatic blister tape acc. IEC 60286-3, Type 2a	12 mm	4 mm	Ø 180 mm/7"
	B7	7000				Ø 330 mm/13"

PART NUMBER AND PRODUCT DESCRIPTION																							
Part Number: MMB02070D5620DB200																							
Part Number: MMB02070Z0000ZB200																							
M	M	B	0	2	0	7	0	D	5	6	2	0	D	B	2	0	0						
M	M	B	0	2	0	7	0	Z	0	0	0	0	Z	B	2	0	0						
TYPE/SIZE			VERSION			TCR			RESISTANCE			TOLERANCE			PACKAGING								
MMU 0102 MMA 0204 MMB 0207			0 = EN 140401-803, "Version A"			D = ± 25 ppm/K C = ± 50 ppm/K B = ± 100 ppm/K Z = Jumper			3 digit value 1 digit multiplier  Multiplier 7 = *10 <sup>-3</sup> 8 = *10 <sup>-2</sup> 9 = *10 <sup>-1</sup> 0 = *10 <sup>0</sup> 1 = *10 <sup>1</sup> 2 = *10 <sup>2</sup> 3 = *10 <sup>3</sup> 4 = *10 <sup>4</sup> 5 = *10 <sup>5</sup> 0000 = Jumper			D = ± 0.5 % F = ± 1 % G = ± 2 % J = ± 5 % Z = Jumper			B3 B0 B2 B7 M3 M8								
Product Description: MMB 0207-25 0.5% B2 562R																							
Product Description: MMB 0207 B2 0R0																							
MMB		0207		-25		0.5 %		B2		562R		MMB		0207		-		-		B2		0R0	
TYPE		SIZE		TCR		TOLERANCE		PACKAGING		RESISTANCE		MMU		0102		± 25 ppm/K		± 0.5 %		BL		562R = 562 Ω	
MMB		0204		± 50 ppm/K		± 1 %		B0		0R0 = Jumper		MMA		0207		± 100 ppm/K		± 2 %		B2			
MMB						± 5 %		B7										M3					
								M8															

Note

- Products can be ordered using either the PART NUMBER or the PRODUCT DESCRIPTION



## DESCRIPTION

Production is strictly controlled and follows an extensive set of instructions established for reproducibility. A homogeneous film of metal alloy is deposited on a high grade ceramic body ( $Al_2O_3$ ) and conditioned to achieve the desired temperature coefficient. Nickel plated steel termination caps are firmly pressed on the metallised rods. A special laser is used to achieve the target value by smoothly cutting a helical groove in the resistive layer without damaging the ceramics. The resistor elements are covered by a protective coating designed for electrical, mechanical and climatic protection. The terminations receive a final pure matte tin on nickel plating. Four or five color code rings designate the resistance value and tolerance in accordance with **IEC 60062** <sup>(1)</sup>.

The result of the determined production is verified by an extensive testing procedure performed on 100 % of the individual resistors. This includes full screening for the elimination of products with a potential risk of early field failures (feasible for  $R \geq 10 \Omega$ ) according to EN 140401-803, 2.1.2.2. Only accepted products are laid directly into the blister tape in accordance with **IEC 60286-3, Type 2a** <sup>(1)</sup> or bulk case in accordance with **IEC 60286-6** <sup>(1)</sup>.

## ASSEMBLY

The resistors are suitable for processing on automatic SMD assembly systems. They are suitable for automatic soldering using wave, reflow or vapor phase as shown in **IEC 61760-1** <sup>(1)</sup>. The encapsulation is resistant to all cleaning solvents commonly used in the electronics industry, including alcohols, esters and aqueous solutions. The suitability of conformal coatings, potting compounds and their processes, if applied, shall be qualified by appropriate means to ensure the long term stability of the whole system.

The resistors are completely lead (Pb)-free, the pure matte tin plating provides compatibility with lead (Pb)-free and lead containing soldering processes. Solderability is specified for 2 years after production or requalification, however, excellent solderability is proven after extended storage in excess of 10 years. The permitted storage time is 20 years. The immunity of the plating against tin whisker growth has been proven under extensive testing.

## MATERIALS

Vishay acknowledges the following systems for the regulation of hazardous substances:

- IEC 62474, Material Declaration for Products of and for the Electrotechnical Industry, with the list of declarable substances given therein <sup>(2)</sup>
- The Global Automotive Declarable Substance List (GADSL) <sup>(3)</sup>
- The REACH regulation (1907/2006/EC) and the related list of substances with very high concern (SVHC) <sup>(4)</sup> for its supply chain

The products do not contain any of the banned substances as per IEC 62474, GADSL, or the SVHC list, see [www.vishay.com/how/leadfree](http://www.vishay.com/how/leadfree).

Hence the products fully comply with the following directives:

- 2000/53/EC End-of-Life Vehicle Directive (ELV) and Annex II (ELV II)
- 2011/65/EU Restriction of the Use of Hazardous Substances Directive (RoHS) with amendment 2015/863/EU
- 2012/19/EU Waste Electrical and Electronic Equipment Directive (WEEE)

Vishay pursues the elimination of conflict minerals from its supply chain, see the Conflict Minerals Policy at [www.vishay.com/doc?49037](http://www.vishay.com/doc?49037).

## APPROVALS

The resistors are approved within the IECQ-CECC Quality Assessment System for Electronic Components according to table "Temperature Coefficient and Resistance Range" to the detail specification **EN 140401-803** which refers to **EN 60115-1**, **EN 60115-8** and the variety of environmental test procedures of the **IEC 60068** <sup>(1)</sup> series.

Conformity is attested by the use of the **CECC** logo () as the mark of conformity on the package label. Vishay Beyschlag has achieved "Approval of Manufacturer" in accordance with **IECQ 03-1**. The release certificate for "Technology Approval Schedule" in accordance with **CECC 240001** based on **IECQ 03-3-1** is granted for the Vishay Beyschlag manufacturing process.

The resistors are qualified according to AEC-Q200.

## RELATED PRODUCTS

For products with precision specification see the datasheet:

- "Precision Thin Film MELF Resistors"  
[www.vishay.com/doc?28714](http://www.vishay.com/doc?28714)
- "Ultra Precision Thin Film MELF Resistors"  
[www.vishay.com/doc?28715](http://www.vishay.com/doc?28715)

Resistors are available with established reliability in accordance with **EN 140401-803 Version E**. Please refer to datasheet "MELF Resistors with Established Reliability".  
[www.vishay.com/doc?28707](http://www.vishay.com/doc?28707)

## Notes

- <sup>(1)</sup> The quoted IEC standards are also released as EN standards with the same number and identical contents
- <sup>(2)</sup> The IEC 62474 list of declarable substances is maintained in a dedicated database, which is available at <http://std.iec.ch/iec62474>
- <sup>(3)</sup> The Global Automotive Declarable Substance List (GADSL) is maintained by the American Chemistry Council and available at [www.gadsl.org](http://www.gadsl.org)
- <sup>(4)</sup> The SVHC list is maintained by the European Chemical Agency (ECHA) and available at <http://echa.europa.eu/candidate-list-table>



**FUNCTIONAL PERFORMANCE**

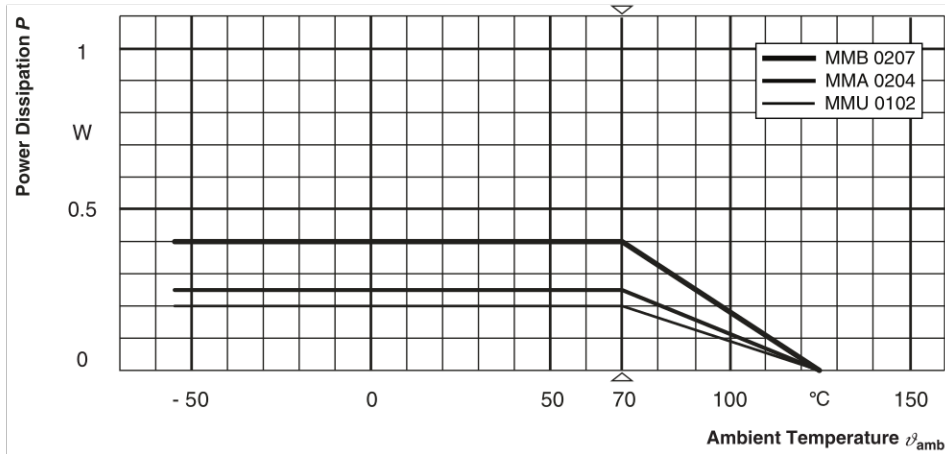

**Derating - Standard Operation Mode**

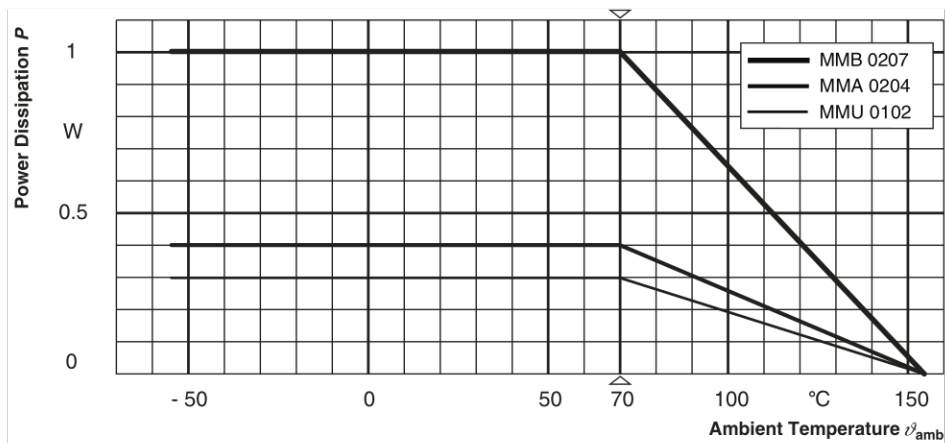

**Derating - Power Operation Mode**

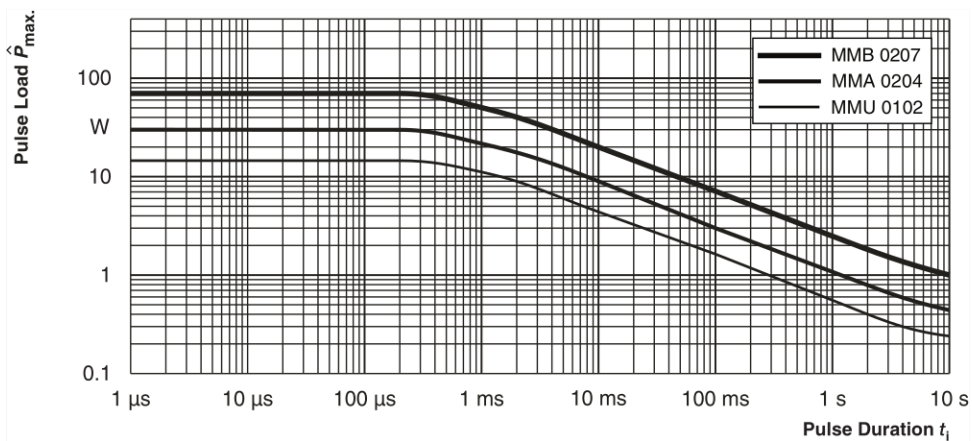

**Single Pulse for R < 10 Ω**

Maximum pulse load, single pulse; applicable if  $\bar{P} \rightarrow 0$  and  $n \leq 1000$  and  $\hat{U} \leq \hat{U}_{max}$ ; for permissible resistance change  $\pm (0.5\% R + 0.01 \Omega)$

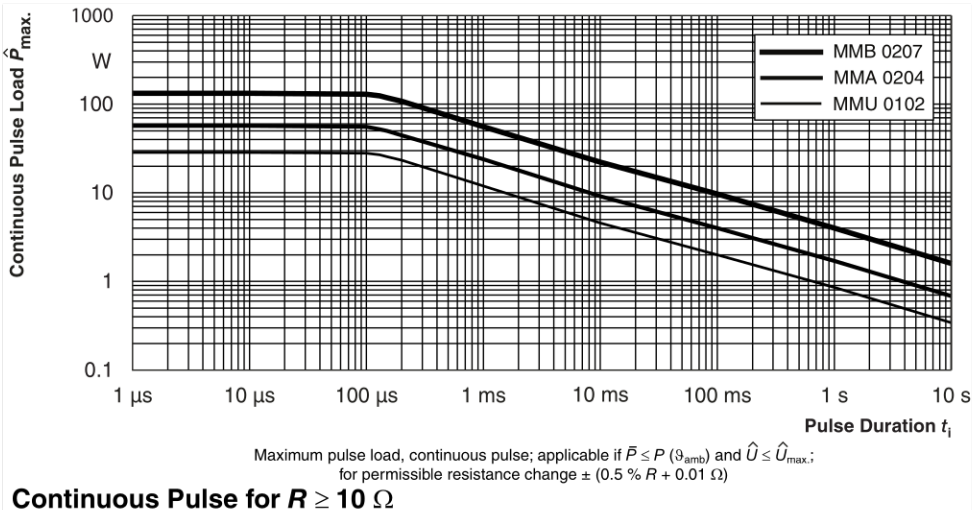
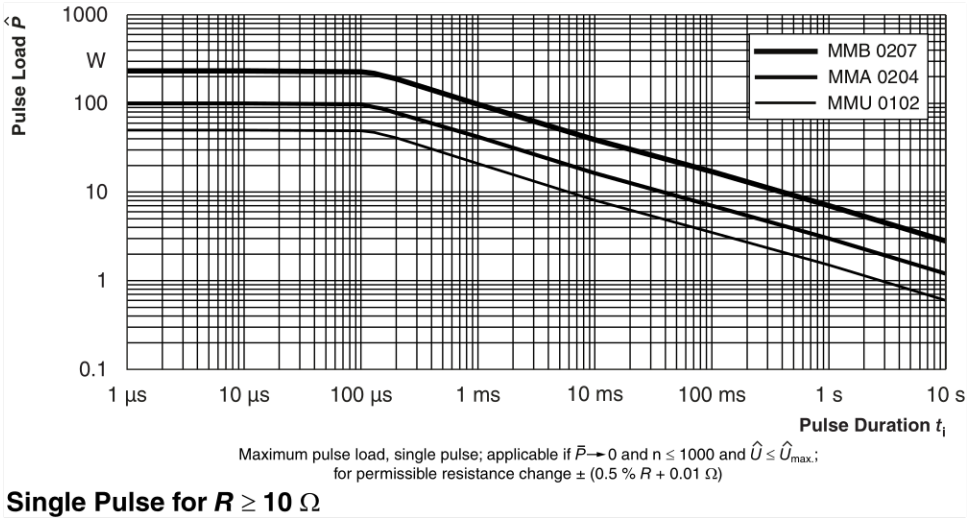
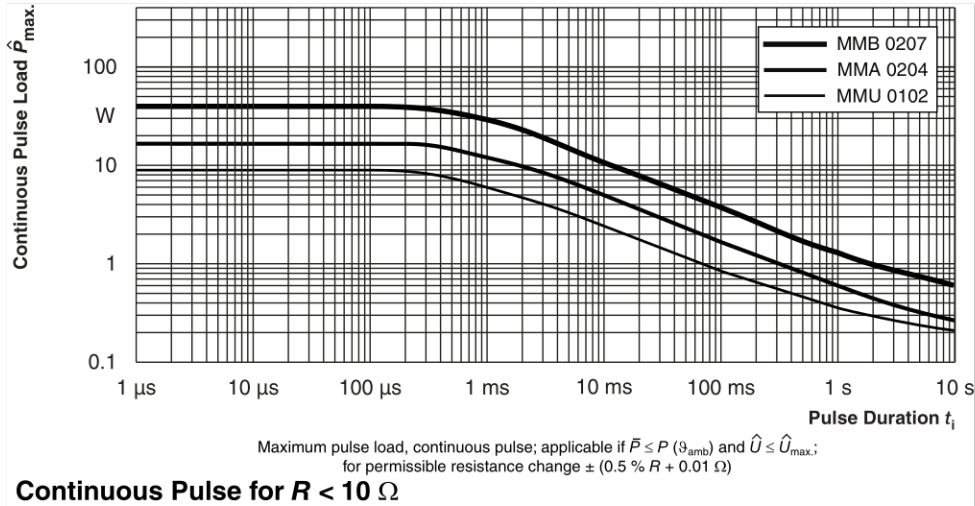

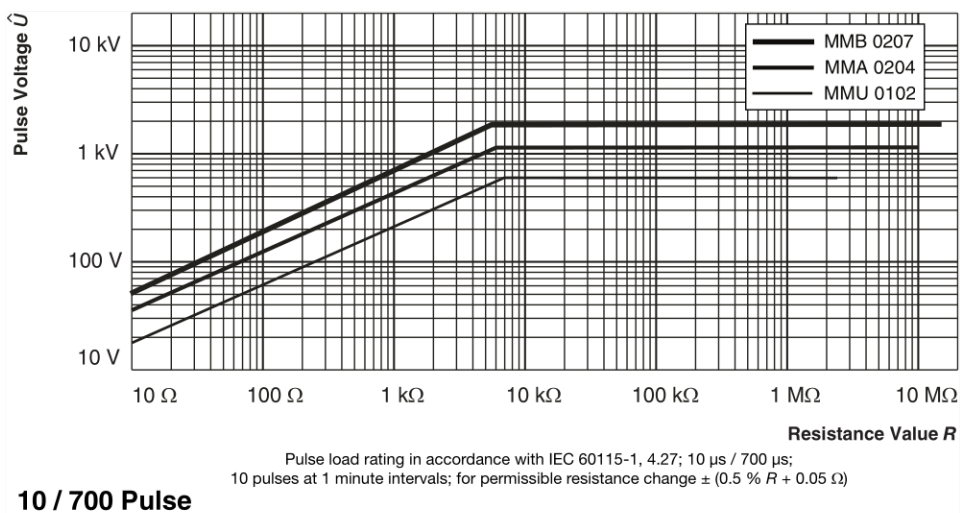
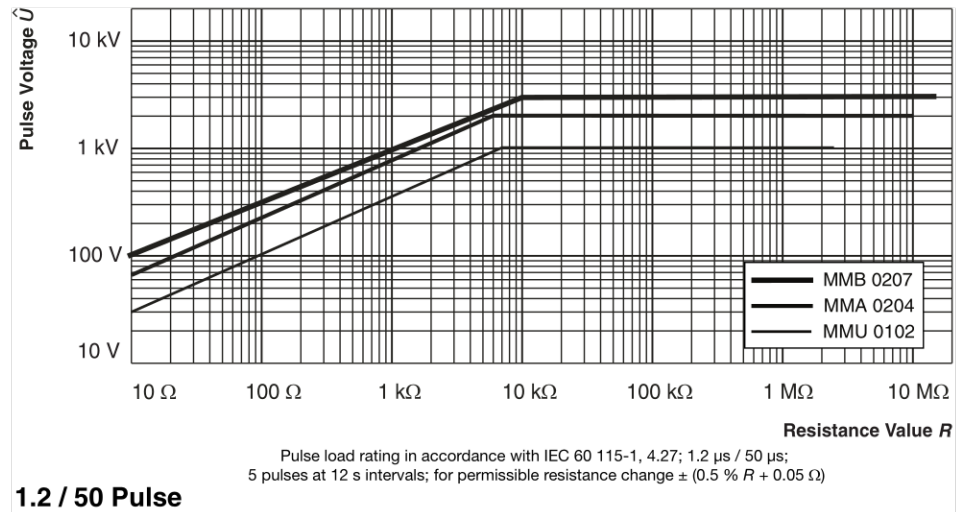
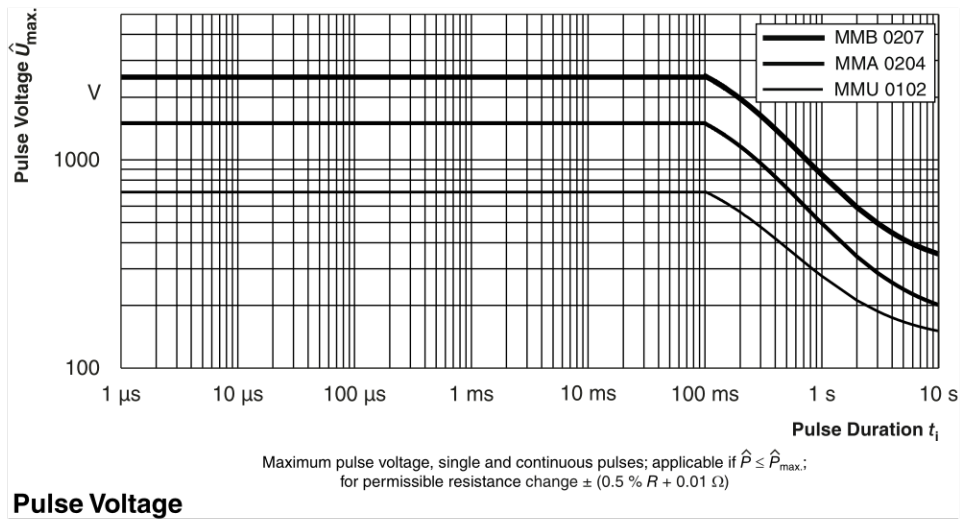

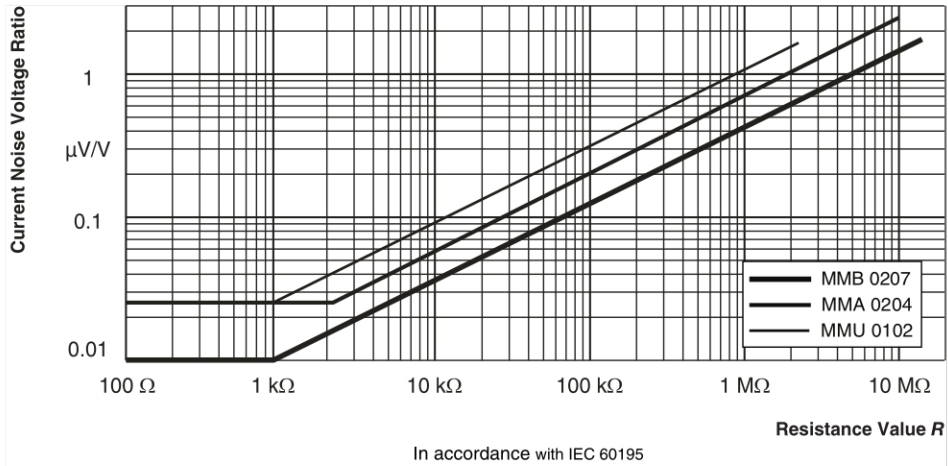

**Current Noise Voltage Ratio**

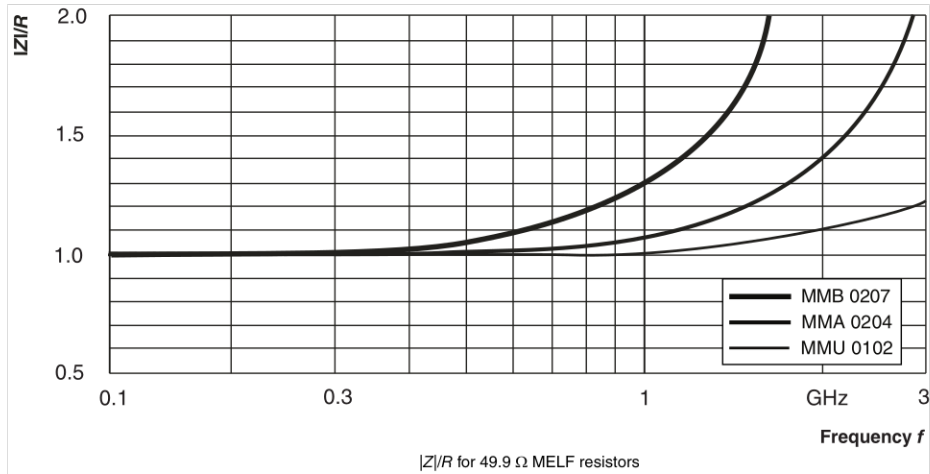

**RF - Behavior**





**TESTS AND REQUIREMENTS**

All tests are carried out in accordance with the following specifications:

- EN 60115-1, generic specification
- EN 60115-8, sectional specification
- EN 140401-803, detail specification
- IEC 60068-2-xx, test methods

The components are approved under the IECQ-CECC quality assessment system for electronic components according to table "Temperature Coefficient and Resistance Range".

The parameters stated in the Test Procedures and Requirements table are based on the required tests and permitted limits of EN 140401-803. The table presents only the most important tests, for the full test schedule refer to the documents listed above. However, some additional tests and a number of improvements against those minimum requirements have been included.

The testing also covers most of the requirements specified by EIA/ECA-703 and JIS-C-5201-1.

The tests are carried out under standard atmospheric conditions in accordance with IEC 60068-1, 4.3, whereupon the following values are applied:

Temperature: 15 °C to 35 °C

Relative humidity: 25 % to 75 %

Air pressure: 86 kPa to 106 kPa (860 mbar to 1060 mbar)

A climatic category LCT / UCT / 56 is applied, defined by the lower category temperature (LCT), the upper category temperature (UCT), and the duration of exposure in the damp heat, steady state test (56 days).

The components are mounted for testing on printed circuit boards in accordance with EN 60115-8, 2.4.2, unless otherwise specified.

TEST PROCEDURES AND REQUIREMENTS							
EN 60115-1 CLAUSE	IEC 60068-2 (1) TEST METHOD	TEST	PROCEDURE	REQUIREMENTS PERMISSIBLE CHANGE ( $\Delta R$ )			
			Stability for product types:	STABILITY CLASS 0.25 OR BETTER	STABILITY CLASS 0.5 OR BETTER	STABILITY CLASS 1 OR BETTER	STABILITY CLASS 2 OR BETTER
			<b>MMU 0102</b>	10 $\Omega$ to 221 k $\Omega$	1 $\Omega$ to < 10 $\Omega$	< 1 $\Omega$	> 221 k $\Omega$
			<b>MMA 0204</b>	10 $\Omega$ to 332 k $\Omega$	1 $\Omega$ to < 10 $\Omega$	< 1 $\Omega$	> 332 k $\Omega$
			<b>MMB 0207</b>	10 $\Omega$ to 1 M $\Omega$	1 $\Omega$ to < 10 $\Omega$	< 1 $\Omega$	> 1 M $\Omega$
4.5	-	Resistance	-	$\pm 1 \% R$ ; $\pm 0.5 \% R$	$\pm 2 \% R$ ; $\pm 1 \% R$	$\pm 5 \% R$ ; $\pm 2 \% R$ ; $\pm 1 \% R$	$\pm 1 \% R$
4.8	-	Temperature coefficient	At (20/-55/20) °C and (20/125/20) °C	$\pm 100$ ppm/K, $\pm 50$ ppm/K, $\pm 25$ ppm/K			
4.25.1	-	Endurance at 70 °C: Standard operation mode	$U = \sqrt{P_{70}} \times R$ or $U = U_{max.}$ ; whichever is the less severe; 1.5 h on; 0.5 h off; 70 °C; 1000 h 70 °C; 8000 h	$\pm (0.15 \% R + 10 \text{ m}\Omega)$ $\pm (0.3 \% R + 10 \text{ m}\Omega)$			
		Endurance at 70 °C: Power operation mode	$U = \sqrt{P_{70}} \times R$ or $U = U_{max.}$ ; whichever is the less severe; 1.5 h on; 0.5 h off; 70 °C; 1000 h 70 °C; 8000 h	$\pm (0.25 \% R + 10 \text{ m}\Omega)$ $\pm (0.5 \% R + 10 \text{ m}\Omega)$			
4.25.3	-	Endurance at upper category temperature	125 °C; 1000 h	$\pm (0.15 \% R + 5 \text{ m}\Omega)$	$\pm (0.25 \% R + 5 \text{ m}\Omega)$		
			155 °C; 1000 h	$\pm (0.3 \% R + 5 \text{ m}\Omega)$	$\pm (0.5 \% R + 5 \text{ m}\Omega)$		
4.24	78 (Cab)	Damp heat, steady state	(40 $\pm$ 2) °C; 56 days; (93 $\pm$ 3) % RH	$\pm (0.15 \% R + 10 \text{ m}\Omega)$	$\pm (0.25 \% R + 10 \text{ m}\Omega)$		
4.37	67 (Cy)	Damp heat, steady state, accelerated	(85 $\pm$ 2) °C; (85 $\pm$ 5) % RH; $U = 0.3 \times \sqrt{P_{70}} \times R$ $\leq 100 \text{ V}$ and $U = 0.3 \times U_{max.}$ ; (the smaller value is valid) 1000 h	$\pm (0.25 \% R + 10 \text{ m}\Omega)$	$\pm (0.5 \% R + 10 \text{ m}\Omega)$	$\pm (1 \% R + 10 \text{ m}\Omega)$	$\pm (2 \% R + 10 \text{ m}\Omega)$



TEST PROCEDURES AND REQUIREMENTS							
EN 60115-1 CLAUSE	IEC 60068-2 (1) TEST METHOD	TEST	PROCEDURE	REQUIREMENTS PERMISSIBLE CHANGE ( $\Delta R$ )			
			Stability for product types:	STABILITY CLASS 0.25 OR BETTER	STABILITY CLASS 0.5 OR BETTER	STABILITY CLASS 1 OR BETTER	STABILITY CLASS 2 OR BETTER
			<b>MMU 0102</b>	10 $\Omega$ to 221 k $\Omega$	1 $\Omega$ to < 10 $\Omega$	< 1 $\Omega$	> 221 k $\Omega$
			<b>MMA 0204</b>	10 $\Omega$ to 332 k $\Omega$	1 $\Omega$ to < 10 $\Omega$	< 1 $\Omega$	> 332 k $\Omega$
			<b>MMB 0207</b>	10 $\Omega$ to 1 M $\Omega$	1 $\Omega$ to < 10 $\Omega$	< 1 $\Omega$	> 1 M $\Omega$
4.23		Climatic sequence:					
4.23.2	2 (Bb)	Dry heat	UCT; 16 h				
4.23.3	30 (Db)	Damp heat, cyclic	55 °C; 24 h; $\geq$ 90 % RH; 1 cycle				
4.23.4	1 (Ab)	Cold	LCT; 2 h				
4.23.5	13 (M)	Low air pressure	8.5 kPa; 2 h; (25 $\pm$ 10) °C	$\pm$ (0.15 % $R$ + 10 m $\Omega$ )	$\pm$ (0.5 % $R$ + 10 m $\Omega$ )	$\pm$ (1 % $R$ + 10 m $\Omega$ )	$\pm$ (1 % $R$ + 10 m $\Omega$ )
4.23.6	30 (Db)	Damp heat, cyclic	55 °C; 24 h; $\geq$ 90 % RH; 5 cycles				
4.23.7	-	DC load	$U = \sqrt{P_{70} \times R}$ or $U_{max.}$ ; 1 min. LCT = - 55 °C; UCT = 155 °C				
-	1 (Ab)	Cold	- 55 °C; 2 h	$\pm$ (0.05 % $R$ + 5 m $\Omega$ )			$\pm$ (0.1 % $R$ + 5 m $\Omega$ )
4.19	14 (Na)	Rapid change of temperature	30 min at LCT; 30 min at UCT; LCT = - 55 °C; UCT = 125 °C				
			5 cycles	$\pm$ (0.05 % $R$ + 10 m $\Omega$ )			$\pm$ (0.1 % $R$ + 10 m $\Omega$ )
			1000 cycles	$\pm$ (0.15 % $R$ + 10 m $\Omega$ )			$\pm$ (0.25 % $R$ + 10 m $\Omega$ )
			LCT = - 55 °C; UCT = 155 °C				
			1000 cycles	$\pm$ (0.25 % $R$ + 10 m $\Omega$ )			$\pm$ (0.5 % $R$ + 10 m $\Omega$ )
4.13	-	Short time overload: Standard operation mode	$U = 2.5 \times \sqrt{P_{70} \times R}$ or $U = 2 \times U_{max.}$ ; whichever is the less severe;	$\pm$ (0.03 % $R$ + 5 m $\Omega$ )			$\pm$ (0.15 % $R$ + 5 m $\Omega$ )
		Short time overload: Power operation mode	5 s	$\pm$ (0.05 % $R$ + 5 m $\Omega$ )			$\pm$ (0.15 % $R$ + 5 m $\Omega$ )
4.27	-	Single pulse high voltage overload: Standard operation mode	Severity no. 4: $U = 10 \times \sqrt{P_{70} \times R}$ or $U = 2 \times U_{max.}$ ; whichever is the less severe;	$\pm$ (0.25 % $R$ + 5 m $\Omega$ )			
		Single pulse high voltage overload: Power operation mode	10 pulses 10 $\mu$ s/700 $\mu$ s	$\pm$ (0.5 % $R$ + 5 m $\Omega$ )			



TEST PROCEDURES AND REQUIREMENTS							
EN 60115-1 CLAUSE	IEC 60068-2 (1) TEST METHOD	TEST	PROCEDURE	REQUIREMENTS PERMISSIBLE CHANGE ( $\Delta R$ )			
			Stability for product types:	STABILITY CLASS 0.25 OR BETTER	STABILITY CLASS 0.5 OR BETTER	STABILITY CLASS 1 OR BETTER	STABILITY CLASS 2 OR BETTER
			<b>MMU 0102</b>	10 $\Omega$ to 221 k $\Omega$	1 $\Omega$ to < 10 $\Omega$	< 1 $\Omega$	> 221 k $\Omega$
			<b>MMA 0204</b>	10 $\Omega$ to 332 k $\Omega$	1 $\Omega$ to < 10 $\Omega$	< 1 $\Omega$	> 332 k $\Omega$
			<b>MMB 0207</b>	10 $\Omega$ to 1 M $\Omega$	1 $\Omega$ to < 10 $\Omega$	< 1 $\Omega$	> 1 M $\Omega$
4.39	-	Periodic electric overload: Standard operation mode	$U = \sqrt{15 \times P_{70} \times R} \text{ or}$ $U = 2 \times U_{max.};$ whichever is the less severe; 0.1 s on; 2.5 s off; 1000 cycles	$\pm (0.5 \% R + 5 \text{ m}\Omega)$			
		Periodic electric overload: Power operation mode		$\pm (1 \% R + 5 \text{ m}\Omega)$			
4.22	6 (Fc)	Vibration	Endurance by sweeping; 10 Hz to 2000 Hz; no resonance; amplitude $\leq 1.5 \text{ mm}$ or $\leq 200 \text{ m/s}^2$ ; 7.5 h	$\pm (0.05 \% R + 5 \text{ m}\Omega)$			$\pm (0.1 \% R + 5 \text{ m}\Omega)$
4.38	-	Electrostatic discharge (Human Body Model)	IEC 61340-3-1 (1); 3 pos. + 3 neg. discharges MMU 0102: 1.5 kV MMA 0204: 2 kV MMB 0207: 4 kV	$\pm (0.5 \% R + 0.05 \Omega)$			
4.17	58 (Td)	Solderability	Solder bath method; SnPb40; non-activated flux; (215 $\pm$ 3) $^{\circ}\text{C}$ ; (3 $\pm$ 0.3) s	Good tinning ( $\geq 95 \%$ covered); no visible damage			
			Solder bath method; SnAg3Cu0.5 or SnAg3.5; non-activated flux; (235 $\pm$ 3) $^{\circ}\text{C}$ ; (2 $\pm$ 0.2) s	Good tinning ( $\geq 95 \%$ covered); no visible damage			
4.18	58 (Td)	Resistance to soldering heat	Solder bath method; (260 $\pm$ 5) $^{\circ}\text{C}$ ; (10 $\pm$ 1) s	$\pm (0.05 \% R + 10 \text{ m}\Omega)$	$\pm (0.1 \% R + 10 \text{ m}\Omega)$	$\pm (0.25 \% R + 10 \text{ m}\Omega)$	$\pm (0.25 \% R + 10 \text{ m}\Omega)$
			Reflow method 2 (IR/forced gas convection); (260 $\pm$ 5) $^{\circ}\text{C}$ ; (10 $\pm$ 1) s	$\pm (0.02 \% R + 10 \text{ m}\Omega)$	$\pm (0.05 \% R + 10 \text{ m}\Omega)$	$\pm (0.05 \% R + 10 \text{ m}\Omega)$	$\pm (0.1 \% R + 10 \text{ m}\Omega)$
4.29	45 (XA)	Component solvent resistance	Isopropyl alcohol; 50 $^{\circ}\text{C}$ ; method 2	No visible damage			
4.30	45 (XA)	Solvent resistance of marking	Isopropyl alcohol; 50 $^{\circ}\text{C}$ ; method 1, toothbrush	Marking legible; no visible damage			
4.32	21 (Ue <sub>3</sub> )	Shear (adhesion)	45 N	No visible damage			
4.33	21 (Ue <sub>1</sub> )	Substrate bending	Depth 2 mm, 3 times	No visible damage, no open circuit in bent position $\pm (0.05 \% R + 5 \text{ m}\Omega)$ (2)			
4.7	-	Voltage proof	$U_{RMS} = U_{ins}$ ; 60 s	No flashover or breakdown			
4.35	-	Flammability	IEC 60695-11-5 (1), needle flame test; 10 s	No burning after 30 s			

**Notes**

(1) The quoted IEC standards are also released as EN standards with the same number and identical contents

(2) Special requirements apply to MICRO-MELF, MMU 0102:

- $R < 100 \Omega$ :  $\pm (0.25 \% R + 10 \text{ m}\Omega)$
- $100 \Omega \leq R \leq 221 \text{ k}\Omega$ :  $\pm 0.1 \% R$
- $221 \text{ k}\Omega < R$ :  $\pm 0.25 \% R$

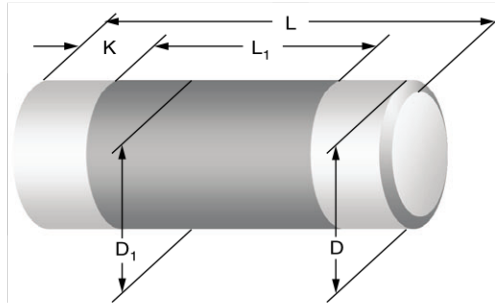
**DIMENSIONS**

DIMENSIONS AND MASS						
TYPE/SIZE	L (mm)	D (mm)	L <sub>1</sub> min. (mm)	D <sub>1</sub> (mm)	K (mm)	MASS (mg)
MMU 0102	2.2 + 0/- 0.1	1.1 + 0/- 0.1	1.2	D + 0/- 0.1	0.4 ± 0.05	8
MMA 0204	3.6 + 0/- 0.2	1.4 + 0/- 0.1	1.8	D + 0/- 0.15	0.75 ± 0.1	22
MMB 0207	5.8 + 0/- 0.15	2.2 + 0/- 0.2	3.2	D + 0/- 0.2	1.1 ± 0.1	80

**Note**

- Color code marking is applied according to IEC 60062 <sup>(1)</sup> in four bands (E24 series) or five bands (E96 or E192 series). Each color band appears as a single solid line, voids are permissible if at least  $\frac{2}{3}$  of the band is visible from each radial angle of view. The last color band for tolerance is approximately 50 % wider than the other bands. An interrupted yellow band between the 4<sup>th</sup> and 5<sup>th</sup> full band indicates TC25

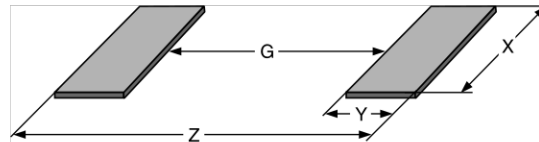
**PATTERN STYLES FOR MELF RESISTORS**

RECOMMENDED SOLDER PAD DIMENSIONS								
TYPE/SIZE	WAVE SOLDERING				REFLOW SOLDERING			
	G (mm)	Y (mm)	X (mm)	Z (mm)	G (mm)	Y (mm)	X (mm)	Z (mm)
MMU 0102	0.7	1.2	1.5	3.1	1.1	0.8	1.3	2.7
MMA 0204	1.5	1.5	1.8	4.5	1.7	1.2	1.6	4.1
MMB 0207	2.8	2.1	2.6	7.0	3.2	1.7	2.4	6.6

**Notes**

- The given solder pad dimensions reflect the considerations for board design and assembly as outlined e.g. in standards IEC 61188-5-x <sup>(1)</sup>, or in publication IPC-7351

<sup>(1)</sup> The quoted IEC standards are also released as EN standards with the same number and identical contents



**HISTORICAL 12NC INFORMATION**

- The resistors had a 12-digit numeric code starting with 2312.
- The subsequent 4 digits indicated the resistor type, specification and packaging; see the 12NC table.
- The remaining 4 digits indicated the resistance value:
  - The first 3 digits indicated the resistance value.
  - The last digit indicated the resistance decade in accordance with the 12NC Indicating Resistance Decade table.

**Last Digit of 12NC Indicating Resistance Decade**

RESISTANCE DECADE	LAST DIGIT
0.1 Ω to 0.999 Ω	7
1 Ω to 9.99 Ω	8
10 Ω to 99.9 Ω	9
100 Ω to 999.9 Ω	1
1 kΩ to 9.99 kΩ	2
10 kΩ to 99.9 kΩ	3
100 kΩ to 999 kΩ	4
1 MΩ to 9.99 MΩ	5
10 MΩ to 99.9 MΩ	6

**Historical 12NC**

The 12NC of a MMU 0102 resistor, value 47 kΩ. and TCR 50 with ± 1 % tolerance, supplied in blister tape of 3000 units per reel is: 2312 165 14703.

<b>HISTORICAL 12NC - Resistor type and packaging</b>						
DESCRIPTION			2312 ... ..			
			BLISTER TAPE ON REEL		BULK CASE	
TYPE	TCR	TOL.	BL 3000 UNITS	B0 10 000 UNITS	M8 8000 UNITS	
MMU 0102	± 50 ppm/K	± 5 %	165 3....	175 3....	060 3....	
		± 2 %	165 2....	175 2....	060 2....	
		± 1 %	165 1....	175 1....	060 1....	
		± 0.5 %	165 5....	175 5....	060 5....	
	± 25 ppm/K	± 1 %	166 1....	176 1....	061 1....	
		± 0.5 %	166 5....	176 5....	061 5....	
	Jumper			165 90001	175 90001	060 90001
TYPE	TCR	TOL.	B2 3000 UNITS	B7 10 000 UNITS	M3 3000 UNITS	
MMA 0204	± 50 ppm/K	± 5 %	155 3....	145 3....	040 3....	
		± 1 %	155 1....	145 1....	040 1....	
		± 0.5 %	155 5....	145 5....	040 5....	
	± 25 ppm/K	± 1 %	156 1....	146 1....	041 1....	
		± 0.5 %	156 5....	146 5....	041 5....	
	Jumper			155 90001	145 90001	040 90001
	MMB 0207	± 100 ppm/K	± 5 %	195 3....	185 3....	
± 50 ppm/K		± 5 %	195 3....	185 3....		
		± 2 %	195 2....	185 2....		
		± 1 %	195 1....	185 1....		
± 25 ppm/K		± 0.5 %	196 5....	186 5....		
Jumper			195 90001	185 90001		



## **Disclaimer**

ALL PRODUCT, PRODUCT SPECIFICATIONS AND DATA ARE SUBJECT TO CHANGE WITHOUT NOTICE TO IMPROVE RELIABILITY, FUNCTION OR DESIGN OR OTHERWISE.

Vishay Intertechnology, Inc., its affiliates, agents, and employees, and all persons acting on its or their behalf (collectively, "Vishay"), disclaim any and all liability for any errors, inaccuracies or incompleteness contained in any datasheet or in any other disclosure relating to any product.

Vishay makes no warranty, representation or guarantee regarding the suitability of the products for any particular purpose or the continuing production of any product. To the maximum extent permitted by applicable law, Vishay disclaims (i) any and all liability arising out of the application or use of any product, (ii) any and all liability, including without limitation special, consequential or incidental damages, and (iii) any and all implied warranties, including warranties of fitness for particular purpose, non-infringement and merchantability.

Statements regarding the suitability of products for certain types of applications are based on Vishay's knowledge of typical requirements that are often placed on Vishay products in generic applications. Such statements are not binding statements about the suitability of products for a particular application. It is the customer's responsibility to validate that a particular product with the properties described in the product specification is suitable for use in a particular application. Parameters provided in datasheets and / or specifications may vary in different applications and performance may vary over time. All operating parameters, including typical parameters, must be validated for each customer application by the customer's technical experts. Product specifications do not expand or otherwise modify Vishay's terms and conditions of purchase, including but not limited to the warranty expressed therein.

Except as expressly indicated in writing, Vishay products are not designed for use in medical, life-saving, or life-sustaining applications or for any other application in which the failure of the Vishay product could result in personal injury or death. Customers using or selling Vishay products not expressly indicated for use in such applications do so at their own risk. Please contact authorized Vishay personnel to obtain written terms and conditions regarding products designed for such applications.

No license, express or implied, by estoppel or otherwise, to any intellectual property rights is granted by this document or by any conduct of Vishay. Product names and markings noted herein may be trademarks of their respective owners.